

# Kit 1629

KIA K5, 4-dr Sedan, 10–

KIA Optima, 4-dr Sedan, 10– / \*11–

\*North America

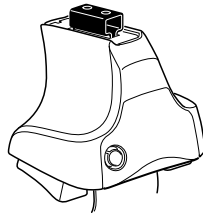

**754** Rapid System  
**480R** Rapid Traverse (North America)

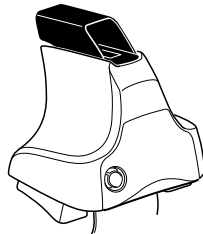
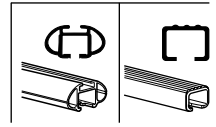

**480** Traverse (North America)

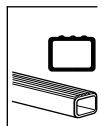

**754 Rapid System**  
**480R Rapid Traverse (North America)**

---

**754 Rapid System**  
**480R Rapid Traverse (North America)**

---

**480 Traverse (North America)**

**(North America)**

- 2x [Bracket]
- 2x [Bolt]
- 2x [Nut]
- 4x [Washer]
- 2x [Bracket]
- 2x [Bolt]
- 2x [Nut]
- 4x [Washer]
- 1x [Bracket]
- 2x [Bolt]
- 2x [Nut]
- 4x [Washer]
- 2x [Bracket]
- 2x [Bolt]

- 2x **1178**
- 2x **1179**
- 1x **235**
- 1x **236**
- 1x **370**
- 1x **371**
- 1x **FR & L FR**  
**FL & R RL**

1

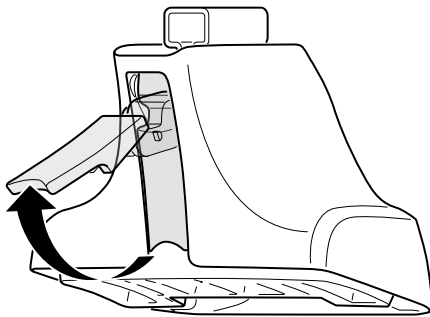

2

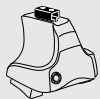

754 Rapid System  
480R Rapid Traverse  
(North America)

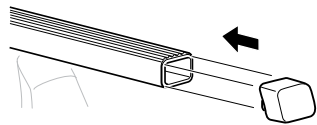
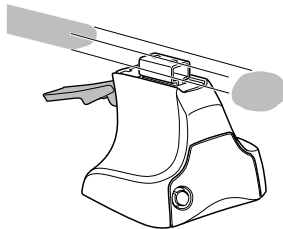

x4

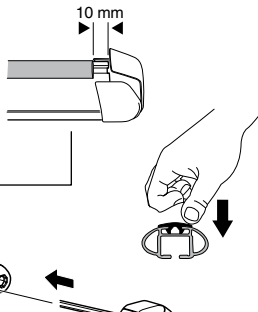
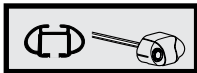

x4

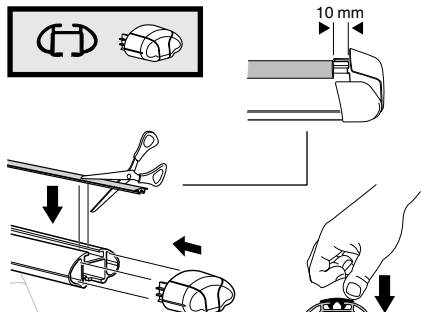
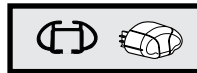

x4



480 Traverse  
(North America)

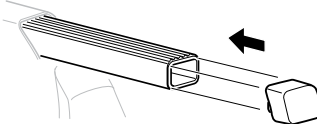
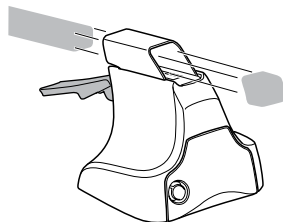

x4

**3**



**754** Rapid System

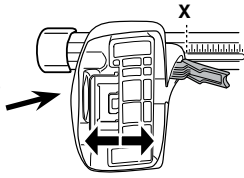

	<b>X</b>
<b>KIA K5, 4-dr Sedan, 10-</b>	<b>43,5</b>
<b>KIA Optima, 4-dr Sedan, 10- / *11-</b>	<b>43,5</b>

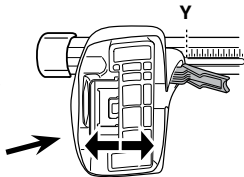

	<b>Y</b>
<b>KIA K5, 4-dr Sedan, 10-</b>	<b>38,5</b>
<b>KIA Optima, 4-dr Sedan, 10- / *11-</b>	<b>38,5</b>

**3**

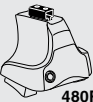

**480R** Rapid Traverse



**480** Traverse

**(North America)**

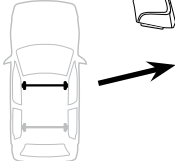

	<b>X inch</b>	<b>X mm</b>
<b>KIA K5, 4-dr Sedan, 10-</b>	<b>42 3/4"</b>	<b>1086 mm</b>
<b>KIA Optima, 4-dr Sedan, 10- / *11-</b>	<b>42 3/4"</b>	<b>1086 mm</b>

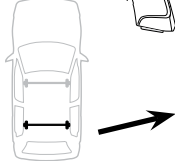

	<b>Y inch</b>	<b>Y mm</b>
<b>KIA K5, 4-dr Sedan, 10-</b>	<b>40 3/4"</b>	<b>1036 mm</b>
<b>KIA Optima, 4-dr Sedan, 10- / *11-</b>	<b>40 3/4"</b>	<b>1036 mm</b>

**4**

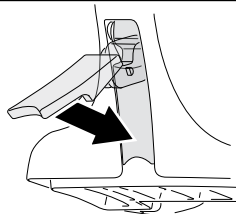

# 5

KIA K5, 4-dr Sedan, 10–  
KIA Optima, 4-dr Sedan, 10– / \*11–

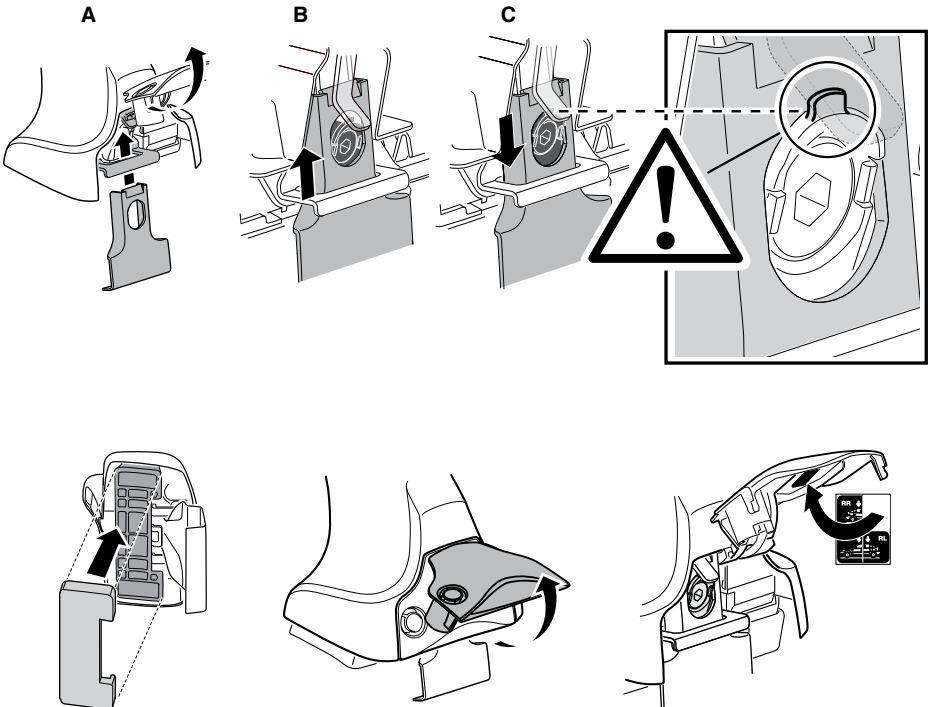
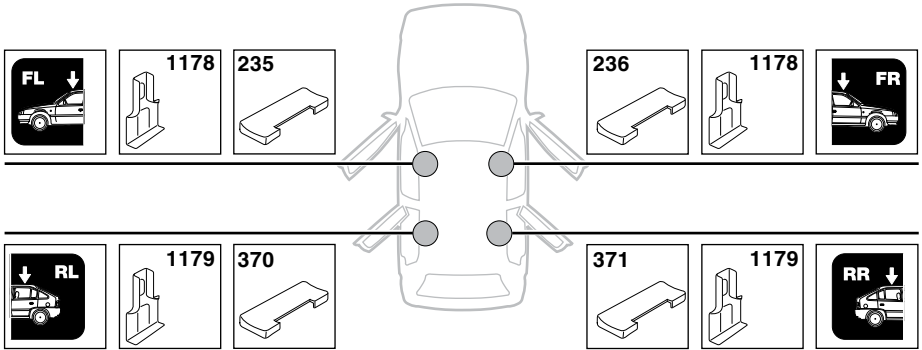

6

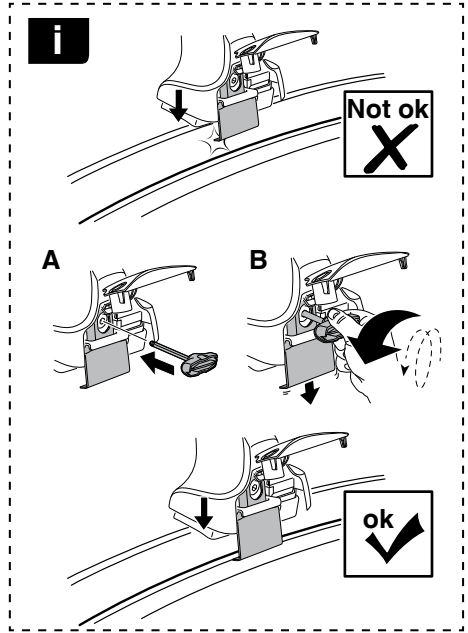

	X mm	Y mm	X inch	Y inch
<b>KIA K5, 4-dr Sedan, 10-</b>	230 mm	665 mm	9"	26 1/8"
<b>KIA Optima, 4-dr Sedan, 10- / *11-</b>	230 mm	665 mm	9"	26 1/8"

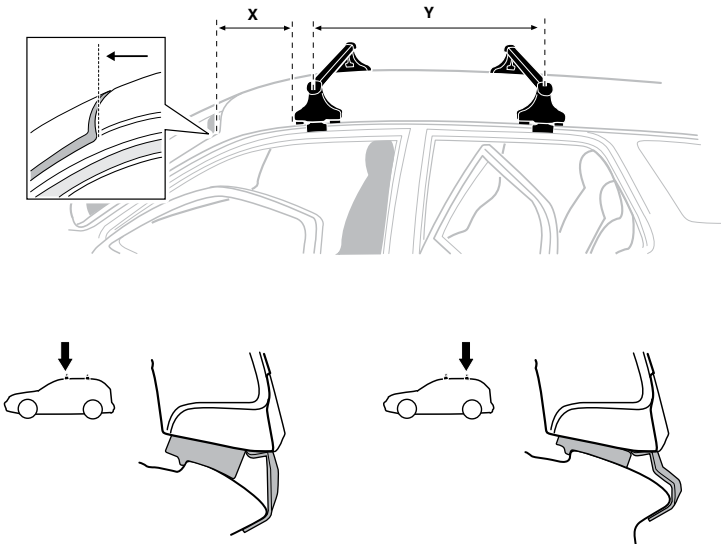

7

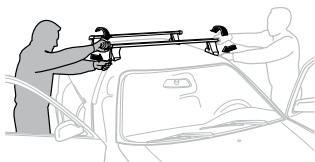

GB/US Tighten alternately  
 D Die Schrauben abwechselnd anziehen  
 F Serrer alternativement chaque côté  
 NL Afwisselend aan de linker- en de rechterkant aandraaien  
 I Alternare il serraggio delle viti  
 E Apertar alternativamente  
 PT Aperte alternadamente  
 S Dra åt växelvis  
 FIN Kierrä vuorotellen  
 EST Pinguldage vaheldumisi  
 LAT Pieļieciet pamišus  
 LIT Užsukinėkite pakaitomis  
 PL Śruby dokręcaj naprzemiennie  
 RU Затягивайте попеременно

CZ Pokręťta bagażnika dokręcaj naprzemiennie.  
 SK Dofahajte striedavo  
 SLO Privijajte izmenično.  
 HR Naizmjerno zategnite  
 HU Egymástól függetlenül szorítandó  
 GR Σφιγίγες εναλλάξ  
 TR Dönüşümlü sıkın

中文 交替拧紧

한국어 번갈아 가며 조이십시오.

日本語 交互に締め付けてください。

ไทย ชันในแบบสลับ

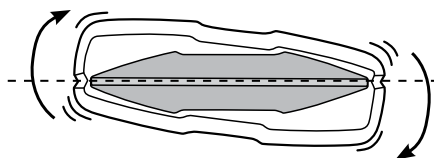
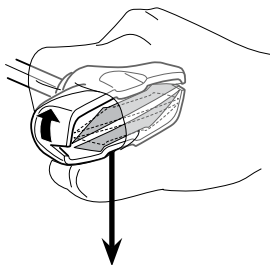
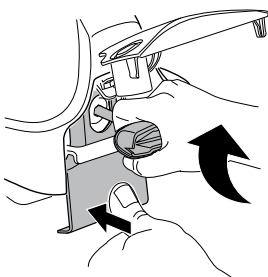
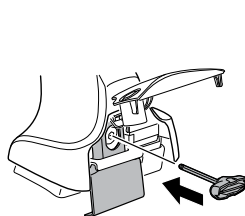

≈ 3 Nm

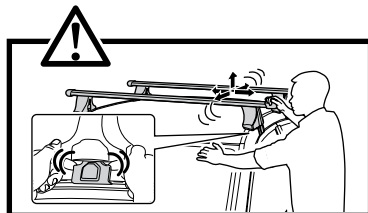
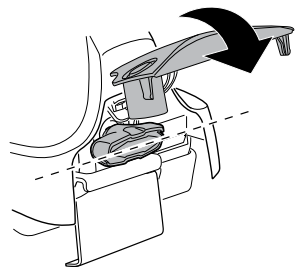

8

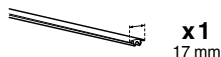

x1  
17 mm

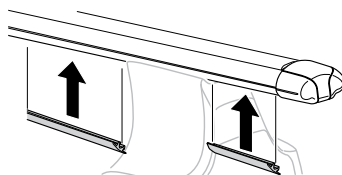

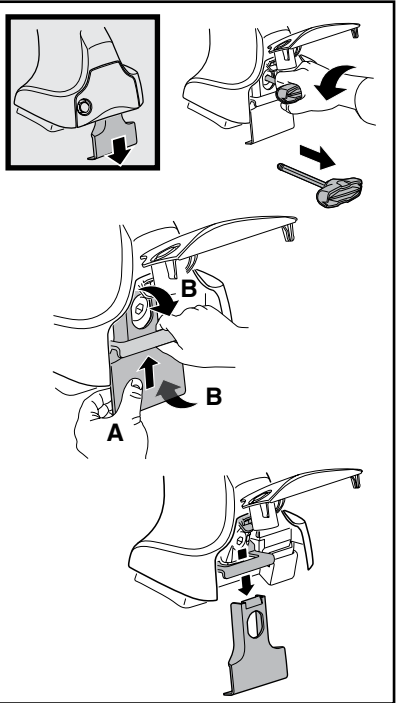
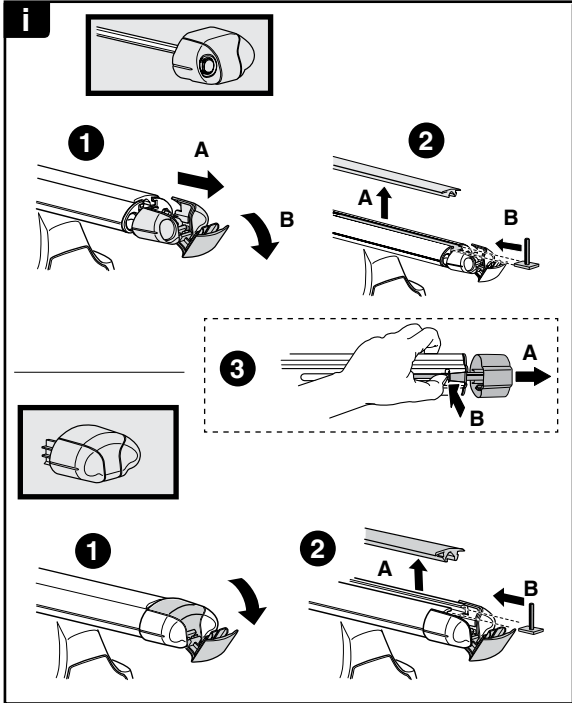

**THULE**  
SWEDEN  
**ONE  
KEY  
SYSTEM**

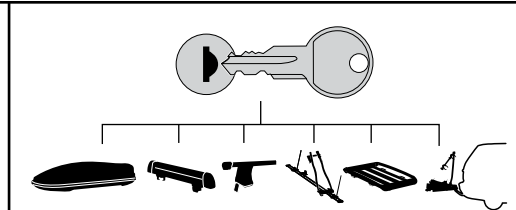

		(x4)
		(x6)
		(x8)
NA		(x10)
EUR		(x12)
ASIA		

