

# Kit 1091

- ACURA SLX**, 5-dr SUV, \*96-99
- ISUZU Big Horn**, 3-dr SUV, 93-97
- ISUZU Big Horn**, 5-dr SUV, 92-97
- ISUZU Trooper**, 3-dr SUV, 93-97
- ISUZU Trooper**, 5-dr SUV, 92-97 / \*92-02
- HOLDEN Jackaroo**, 3-dr SUV, 93-97
- HOLDEN Jackaroo**, 5-dr SUV, 92-97
- OPEL Monterey**, 3-dr SUV, 93-97
- OPEL Monterey**, 5-dr SUV, 92-97
- VAUXHALL Monterey**, 3-dr SUV, 93-97
- VAUXHALL Monterey**, 5-dr SUV, 93-97

\*North America

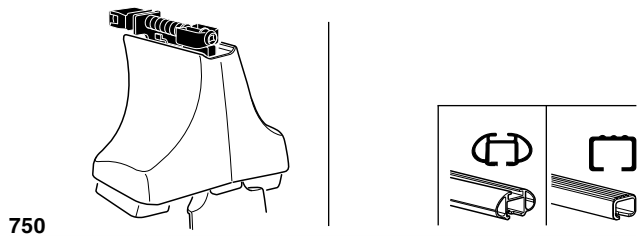
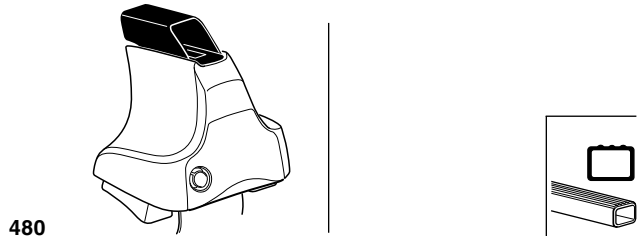
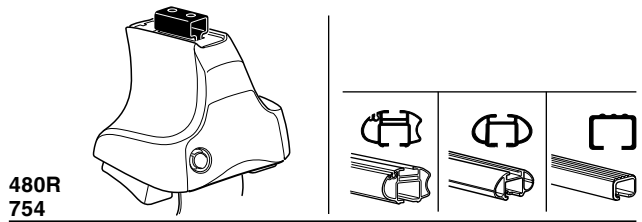

**Max. 75kg**  
**Max. 165 lbs**

x1

x4

x4

x4

x4

**480R/754**

---

x1

x4

x4

x4

**480**

---

x1

x4

x4

**750**

x2 x2 x2 x4	x2	x2 x2 x4 x4	x2 x2	x2
----------------------	----	----------------------	----------	----

**186** x4

**15** x4

x1

**Kit**

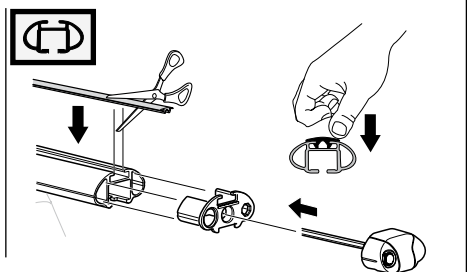
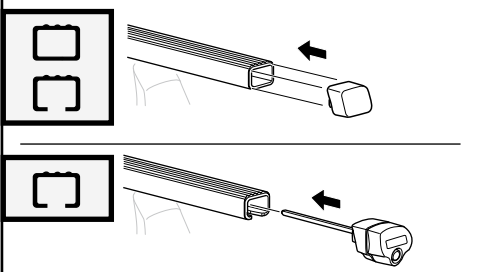
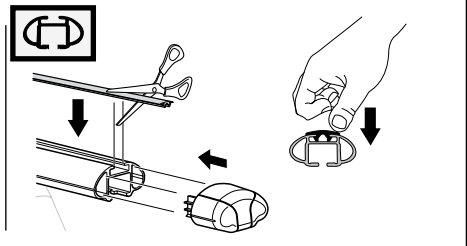
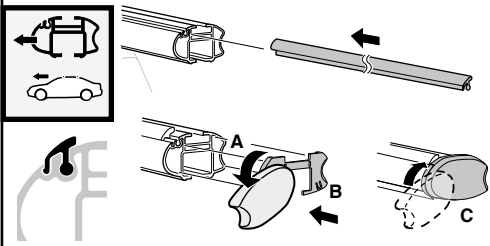

3

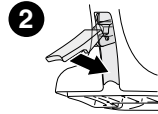
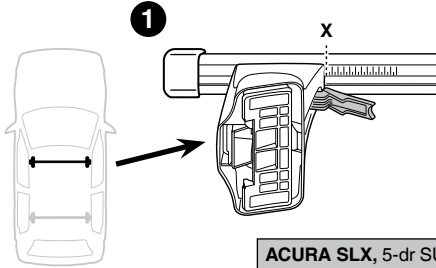
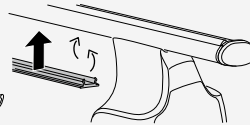
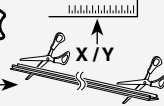
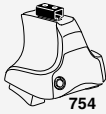

	X
<b>ACURA SLX, 5-dr SUV, *96-99</b>	46
<b>ISUZU Big Horn, 3-dr SUV, 93-97</b>	50
<b>ISUZU Big Horn, 5-dr SUV, 92-97</b>	46
<b>ISUZU Trooper, 3-dr SUV, 93-97</b>	50
<b>ISUZU Trooper, 5-dr SUV, 92-97 / *92-02</b>	46
<b>HOLDEN Jackaroo, 3-dr SUV, 93-97</b>	50
<b>HOLDEN Jackaroo, 5-dr SUV, 92-97</b>	46
<b>OPEL Monterey, 3-dr SUV, 93-97</b>	50
<b>OPEL Monterey, 5-dr SUV, 92-97</b>	46
<b>VAUXHALL Monterey, 3-dr SUV, 93-97</b>	50
<b>VAUXHALL Monterey, 5-dr SUV, 93-97</b>	46

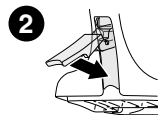
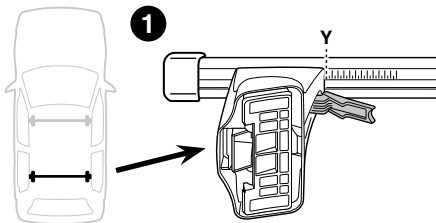

	Y
<b>ACURA SLX, 5-dr SUV, *96-99</b>	45
<b>ISUZU Big Horn, 3-dr SUV, 93-97</b>	45,5
<b>ISUZU Big Horn, 5-dr SUV, 92-97</b>	45
<b>ISUZU Trooper, 3-dr SUV, 93-97</b>	45,5
<b>ISUZU Trooper, 5-dr SUV, 92-97 / *92-02</b>	45
<b>HOLDEN Jackaroo, 3-dr SUV, 93-97</b>	45,5
<b>HOLDEN Jackaroo, 5-dr SUV, 92-97</b>	45
<b>OPEL Monterey, 3-dr SUV, 93-97</b>	45,5
<b>OPEL Monterey, 5-dr SUV, 92-97</b>	45
<b>VAUXHALL Monterey, 3-dr SUV, 93-97</b>	45,5
<b>VAUXHALL Monterey, 5-dr SUV, 93-97</b>	45

**3**



480R



480

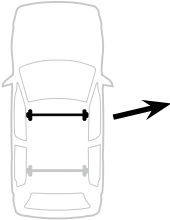
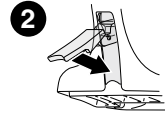
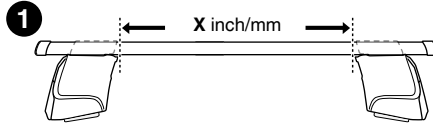

	X inch	X mm
<b>ACURA SLX, 5-dr SUV, *96-99</b>	43 <sup>3</sup> / <sub>4</sub> "	1111 mm
<b>ISUZU Big Horn, 3-dr SUV, 93-97</b>	45 <sup>3</sup> / <sub>8</sub> "	1151 mm
<b>ISUZU Big Horn, 5-dr SUV, 92-97</b>	43 <sup>3</sup> / <sub>4</sub> "	1111 mm
<b>ISUZU Trooper, 3-dr SUV, 93-97</b>	45 <sup>3</sup> / <sub>8</sub> "	1151 mm
<b>ISUZU Trooper, 5-dr SUV, 92-97 / *92-02</b>	43 <sup>3</sup> / <sub>4</sub> "	1111 mm
<b>HOLDEN Jackaroo, 3-dr SUV, 93-97</b>	45 <sup>3</sup> / <sub>8</sub> "	1151 mm
<b>HOLDEN Jackaroo, 5-dr SUV, 92-97</b>	43 <sup>3</sup> / <sub>4</sub> "	1111 mm
<b>OPEL Monterey, 3-dr SUV, 93-97</b>	45 <sup>3</sup> / <sub>8</sub> "	1151 mm
<b>OPEL Monterey, 5-dr SUV, 92-97</b>	43 <sup>3</sup> / <sub>4</sub> "	1111 mm
<b>VAUXHALL Monterey, 3-dr SUV, 93-97</b>	45 <sup>3</sup> / <sub>8</sub> "	1151 mm
<b>VAUXHALL Monterey, 5-dr SUV, 93-97</b>	43 <sup>3</sup> / <sub>4</sub> "	1111 mm

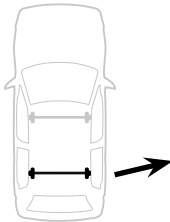
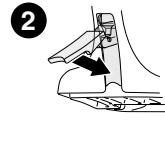
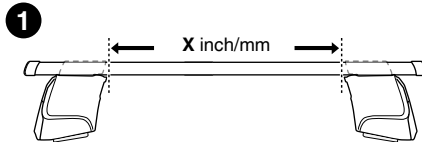

	X inch	X mm
<b>ACURA SLX, 5-dr SUV, *96-99</b>	43 <sup>3</sup> / <sub>8</sub> "	1101 mm
<b>ISUZU Big Horn, 3-dr SUV, 93-97</b>	43 <sup>1</sup> / <sub>2</sub> "	1106 mm
<b>ISUZU Big Horn, 5-dr SUV, 92-97</b>	43 <sup>3</sup> / <sub>8</sub> "	1101 mm
<b>ISUZU Trooper, 3-dr SUV, 93-97</b>	43 <sup>1</sup> / <sub>2</sub> "	1106 mm
<b>ISUZU Trooper, 5-dr SUV, 92-97 / *92-02</b>	43 <sup>3</sup> / <sub>8</sub> "	1101 mm
<b>HOLDEN Jackaroo, 3-dr SUV, 93-97</b>	43 <sup>1</sup> / <sub>2</sub> "	1106 mm
<b>HOLDEN Jackaroo, 5-dr SUV, 92-97</b>	43 <sup>3</sup> / <sub>8</sub> "	1101 mm
<b>OPEL Monterey, 3-dr SUV, 93-97</b>	43 <sup>1</sup> / <sub>2</sub> "	1106 mm
<b>OPEL Monterey, 5-dr SUV, 92-97</b>	43 <sup>3</sup> / <sub>8</sub> "	1101 mm
<b>VAUXHALL Monterey, 3-dr SUV, 93-97</b>	43 <sup>1</sup> / <sub>2</sub> "	1106 mm
<b>VAUXHALL Monterey, 5-dr SUV, 93-97</b>	43 <sup>3</sup> / <sub>8</sub> "	1101 mm

# 4

ISUZU Big Horn, 3-dr SUV, 93-97

ISUZU Trooper, 3-dr SUV, 93-97

HOLDEN Jackaroo, 3-dr SUV, 93-97

OPEL Monterey, 3-dr SUV, 93-97

VAUXHALL Monterey, 3-dr SUV, 93-97

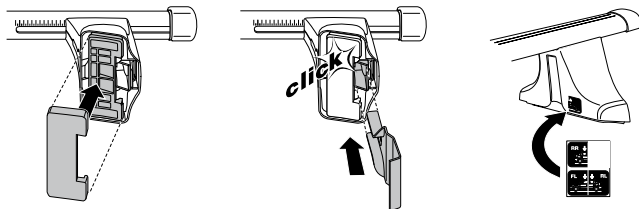
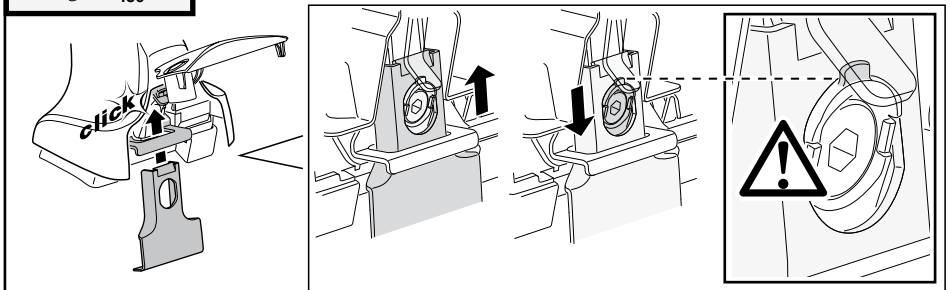
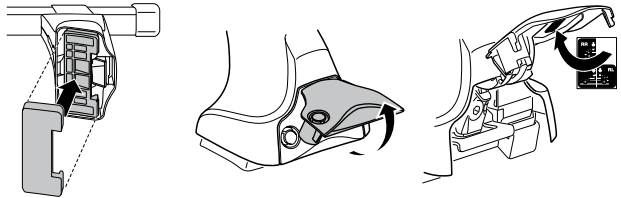
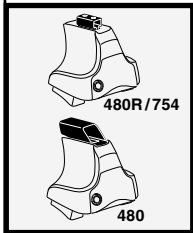
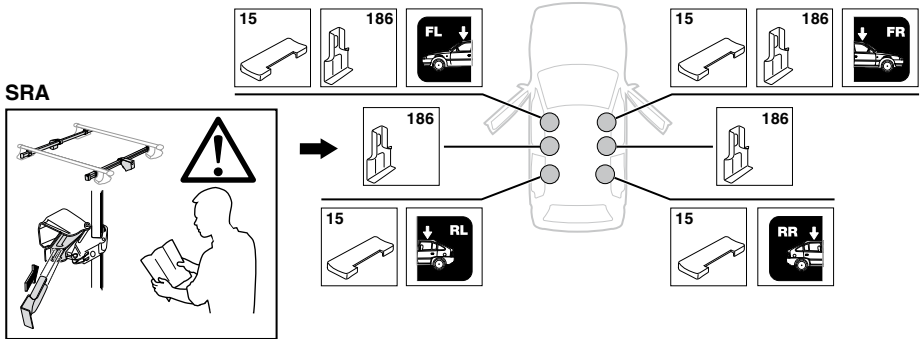

# 4

**ACURA SLX**, 5-dr SUV, \*96-99

**ISUZU Big Horn**, 5-dr SUV, 92-97

**ISUZU Trooper**, 5-dr SUV, 92-97 / \*92-02

**HOLDEN Jackaroo**, 5-dr SUV, 92-97

**OPEL Monterey**, 5-dr SUV, 92-97

**VAUXHALL Monterey**, 5-dr SUV, 93-97

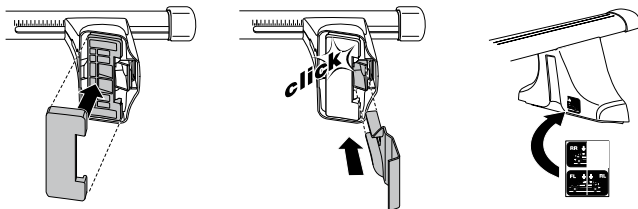
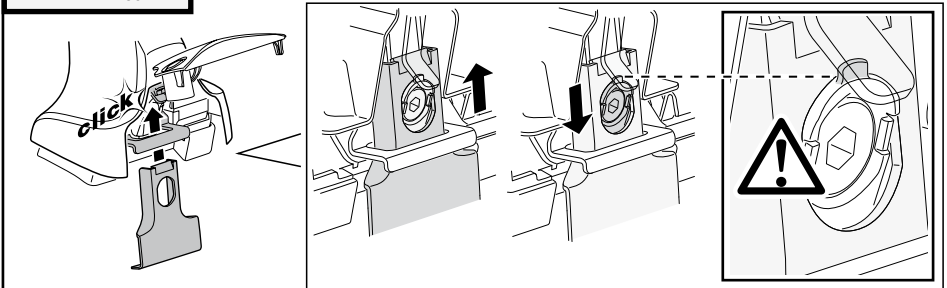
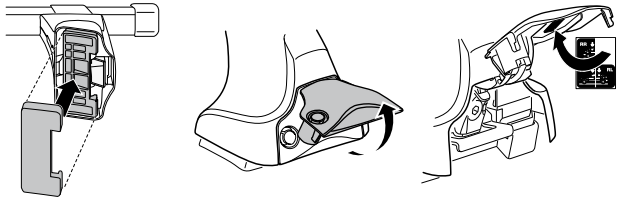
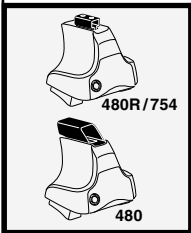
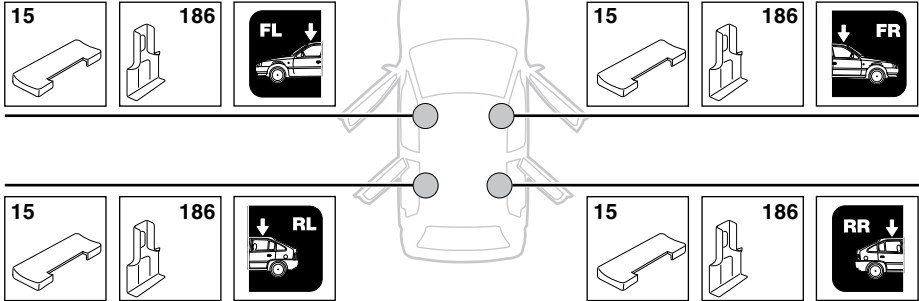

5

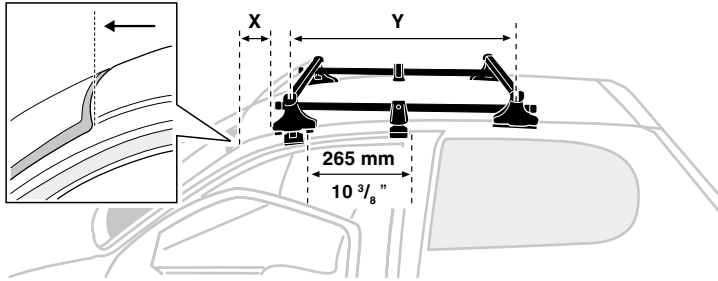
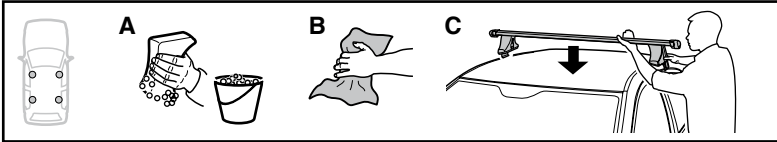

	X mm	Y mm	X inch	Y inch
<b>ISUZU Big Horn</b> , 3-dr SUV, 93-97	125 mm	720 mm	4 <sup>7</sup> / <sub>8</sub> "	28 <sup>3</sup> / <sub>8</sub> "
<b>ISUZU Trooper</b> , 3-dr SUV, 93-97	125 mm	720 mm	4 <sup>7</sup> / <sub>8</sub> "	28 <sup>3</sup> / <sub>8</sub> "
<b>HOLDEN Jackaroo</b> , 3-dr SUV, 93-97	125 mm	720 mm	4 <sup>7</sup> / <sub>8</sub> "	28 <sup>3</sup> / <sub>8</sub> "
<b>OPEL Monterey</b> , 3-dr SUV, 93-97	125 mm	720 mm	4 <sup>7</sup> / <sub>8</sub> "	28 <sup>3</sup> / <sub>8</sub> "
<b>VAUXHALL Monterey</b> , 3-dr SUV, 93-97	125 mm	720 mm	4 <sup>7</sup> / <sub>8</sub> "	28 <sup>3</sup> / <sub>8</sub> "

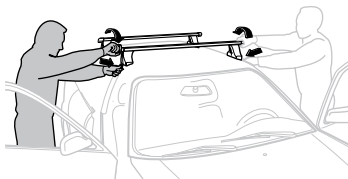

**GB/US** Tighten alternately

**D** Die Schrauben abwechselnd anziehen

**F** Serrer alternativement chaque côté

**NL** Afwisselend aan de linker- en de rechterkant aandraaien

**I** Alternare il serraggio delle viti

**E** Serrare alternativamente

**PT** Aperte alternadamente

**S** Dra åt växelvis

**FIN** Kierrä vuorotellen

**EST** Pinguldage vaheldumisi

**LAT** Pielveiciet pamišus

**LIT** Užsukinėkite pakaitomis

**PL** Śruby dokręcaj naprzemiennie

**RU** Затягивайте попеременно

**CZ** Pokręťta багаžníka dokręcaj dokręcaj naprzemiennie.

**SK** Doťahujte striedavo

**SLO** Privijajte izmenično.

**HR** Naizmjenično zategnite

**HU** Egymástól függetlenül szorítandó

**GR** Σφιγγετε εναλλάξ

**TR** Dönüşümlü sıkın

**中文** 交替拧紧

**한국어** 번갈아 가며 조이십시오.

**日本語** 交互に締め付けてください。

**ไทย** ชันในแบบสลับ



5

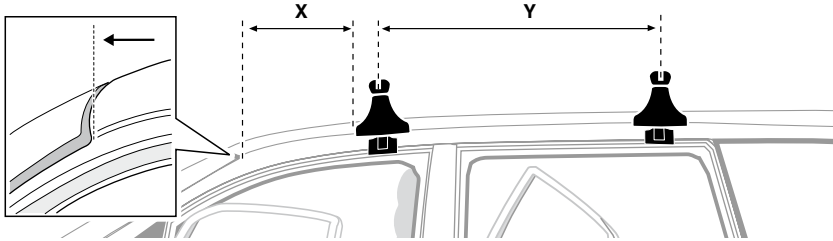
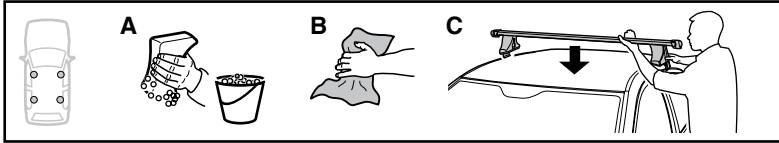

	X mm	Y mm	X inch	Y inch
<b>ACURA SLX</b> , 5-dr SUV, *96-99	365 mm	736 mm	14 <sup>3</sup> / <sub>8</sub> "	29 "
<b>ISUZU Big Horn</b> , 5-dr SUV, 92-97	365 mm	736 mm	14 <sup>3</sup> / <sub>8</sub> "	29 "
<b>ISUZU Trooper</b> , 5-dr SUV, 92-97 / *92-02	365 mm	736 mm	14 <sup>3</sup> / <sub>8</sub> "	29 "
<b>HOLDEN Jackaroo</b> , 5-dr SUV, 92-97	365 mm	736 mm	14 <sup>3</sup> / <sub>8</sub> "	29 "
<b>OPEL Monterey</b> , 5-dr SUV, 92-97	365 mm	736 mm	14 <sup>3</sup> / <sub>8</sub> "	29 "
<b>VAUXHALL Monterey</b> , 5-dr SUV, 93-97	365 mm	736 mm	14 <sup>3</sup> / <sub>8</sub> "	29 "

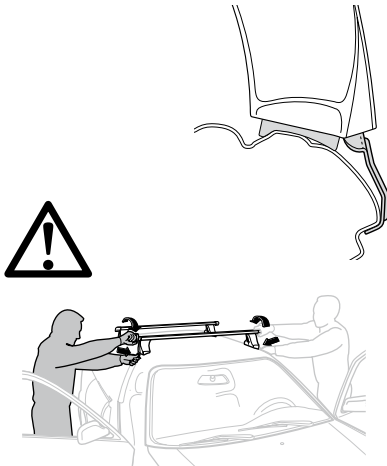

**GB/US** Tighten alternately

**D** Die Schrauben abwechselnd anziehen

**F** Serrer alternativement chaque côté

**NL** Afwisselend aan de linker- en de rechterkant aandraaien

**I** Alternare il serraggio delle viti

**E** Serrare alternativamente

**PT** Aperte alternadamente

**S** Dra åt växelvis

**FIN** Kierrä vuorotellen

**EST** Pinguldage vaheldumisi

**LAT** Pielvelciēt pamišus

**LIT** Užsukinėkite pakaitomis

**PL** Śruby dokręcaj naprzemiennie

**RU** Затягивайте попеременно

**CZ** Pokręťta багаžníka dokręcaj dokręcaj naprzemiennie.

**SK** Doťahujte striedavo

**SLO** Privijajte izmenično.

**HR** Naizmjenično zategnite

**HU** Egymástól függetlenül szorítandó

**GR** Σφίγγετε εναλλάξ

**TR** Dönüşümlü sıkın

**中文** 交替拧紧

**한국어** 번갈아 가며 조이십시오.

**日本語** 交互に締め付けてください。

**ไทย** ขันในแบบสลับ

6

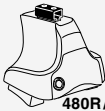

480R/754



480

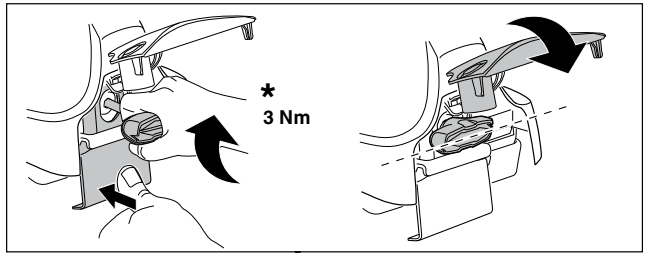
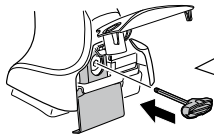

\*  
3 Nm

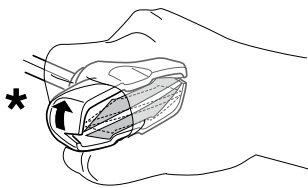

\*

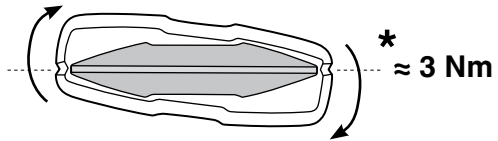

\*  
≈ 3 Nm

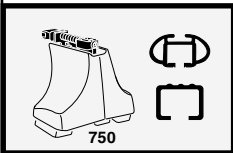
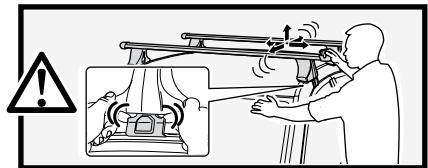

750

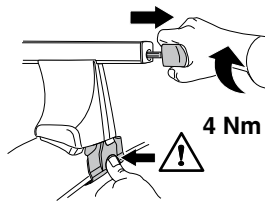

4 Nm

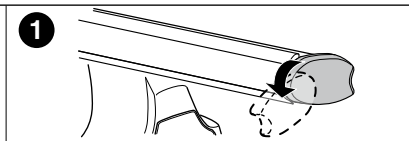
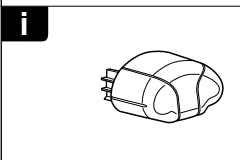
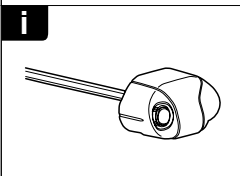
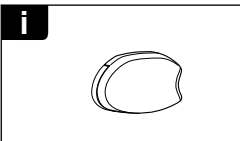
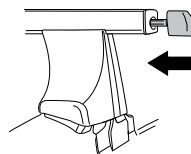

1

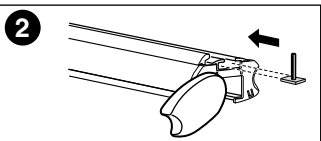

2

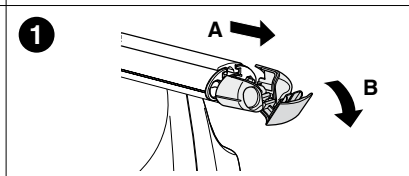

1

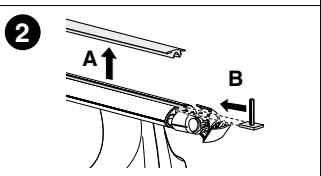

2

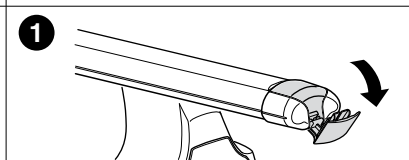

1

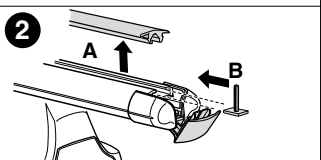





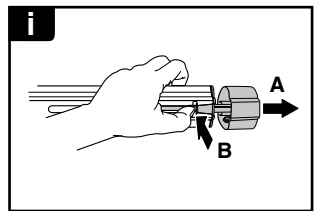
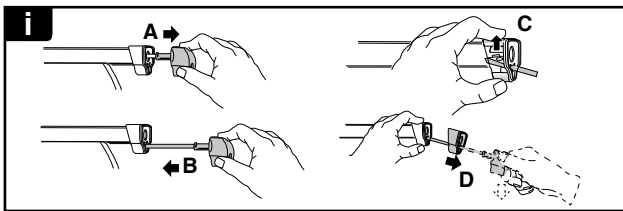
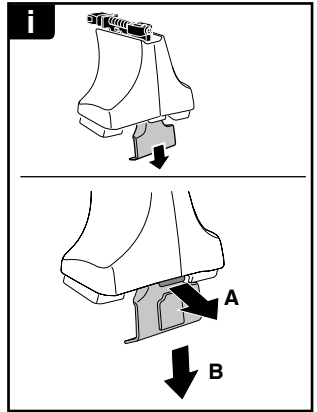
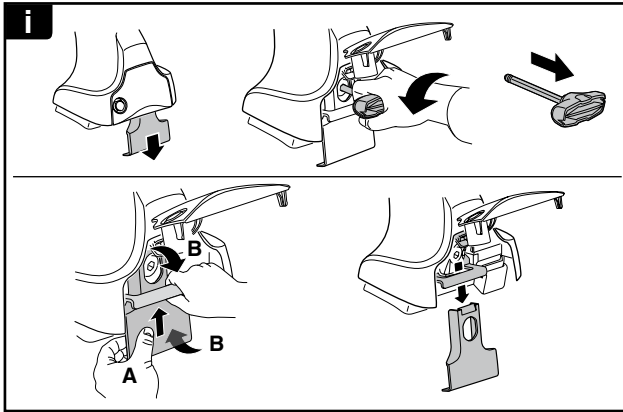
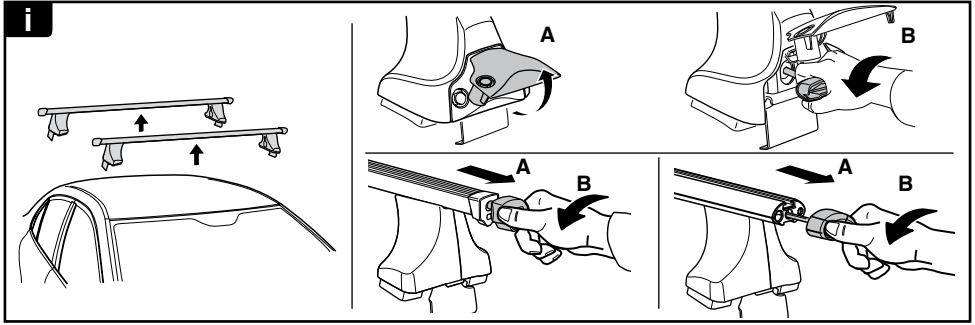

2

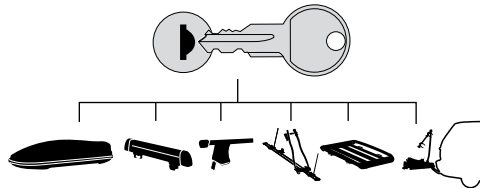



**THULE**  
SWEDEN  
**ONE  
KEY  
SYSTEM**



-  **544** (x4)
  -  **596** (x6)
  -  **588** (x8)
  -  **510** (x10)
  -  **452** (x12)
- NA  
EUR  
ASIA

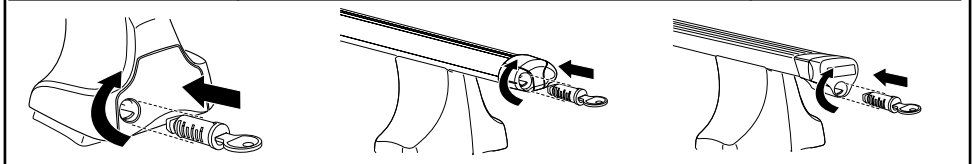

WW ▶ Thule Sweden AB, Box 69, 330 33 Hillerstorp, SWEDEN  
NA ▶ Thule Inc., 42 Silvermine Road, Seymour, Connecticut 06483, USA

info@thule.com  
customer.service@thule.com

 www.thule.com