

Professional BATTERY CHARGERS

BATTERY MANAGER





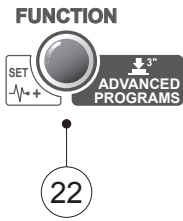
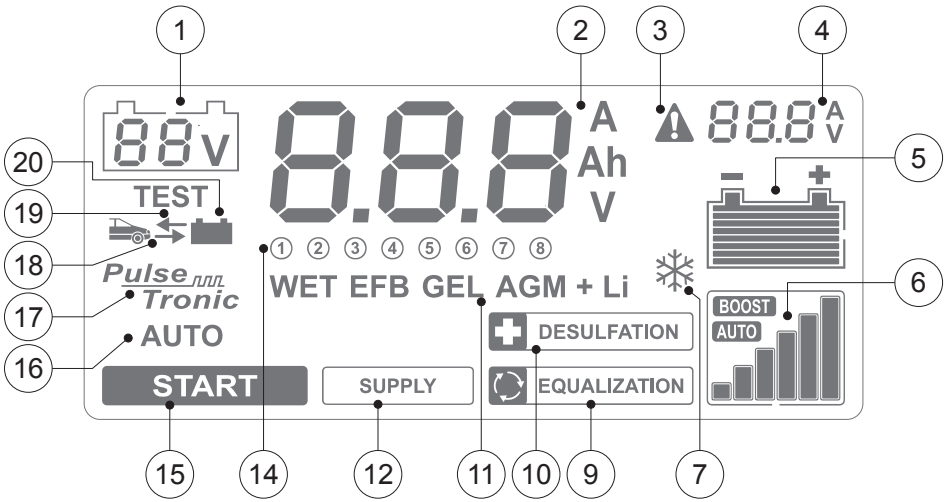

EN INSTRUCTION MANUAL.....55	HU HASZNÁLATI UTASÍTÁS.....118	HR-SR PRIRUČNIK ZA UPOTREBU.....181
IT MANUALE D'ISTRUZIONE.....62	RO MANUAL DE INSTRUȚIUNI...125	LT INSTRUKCIJŲ KNYGELĖ.....188
FR MANUEL D'INSTRUCTIONS.....69	SV BRUKSANVISNING.....132	ET KASUTUSJUHEND.....195
ES MANUAL DE INSTRUCCIONES.....76	DA INSTRUKTIONSMANUAL.....139	LV ROKASGRĀMATA.....202
DE BEDIENUNGSANLEITUNG.....83	NO BRUKERVEILEDNING.....146	BG РЪКОВОДСТВО С ИНСТРУКЦИИ.....209
RU РУКОВОДСТВО ПОЛЬЗОВАТЕЛЯ.....90	FI OHJEKIRJA.....153	PL INSTRUKCJA OBSŁUGI.....216
PT MANUAL DE INSTRUÇÕES.....97	CS NÁVOD K POUŽITÍ.....160	AR دليل الارشادات.....223
EL ΕΓΧΕΙΡΙΔΙΟ ΧΡΗΣΗΣ.....104	SK NÁVOD NA POUŽITIE.....167	
NL INSTRUCTIEHANDLEIDING.....111	SL PRIROČNIK Z NAVODILI ZA UPORABO.....174	

GENERAL SAFETY..... 5-54

EN GENERAL SAFETY RULES FOR THE USE **IT** SICUREZZA GENERALE PER L'USO **FR** INSTRUCTIONS GÉNÉRALES DE SÉCURITÉ POUR L'UTILISATION **ES** SEGURIDAD GENERAL PARA EL USO **DE** ALLGEMEINE SICHERHEITSVORSCHRIFTEN FÜR DEN GEBRAUCH **RU** ОБЩАЯ БЕЗОПАСНОСТЬ ПРИ ИСПОЛЬЗОВАНИИ **PT** SEGURANÇA GERAL PARA O USO **EL** ΓΕΝΙΚΗ ΑΣΦΑΛΕΙΑ ΓΙΑ ΤΗ ΧΡΗΣΗ **NL** ALGEMENE VEILIGHEID VOOR HET GEBRUIK **HU** ÁLTALÁNOS HASZNÁLATI BIZTONSÁGI ELŐÍRÁSOK **RO** SIGURANȚA GENERALĂ PENTRU FOLOSIRE **SV** ALLMÄNNA SÄKERHETSANVISNINGAR **DA** ALMENE SIKKERHEDSREGLER FOR ANVENDELSE **NO** GENERELLE FORHOLDSREGLER FOR BRUK **FI** YLEISET TURVALLISUUSOHJEET KÄYTTÖÄ VARTEN **CS** ZÁKLADNÍ BEZPEČNOSTNÍ POKYNY PRO POUŽITÍ **SK** ZÁKLADNÉ BEZPEČNOSTNÉ POKYNY PRE POUŽITIE **SL** SPLOŠNA VARNOST PRI UPORABI **HR-SR** OPĆA SIGURNOST PRILIKOM UPOTREBE **LT** BENDRIEJI SAUGOS REIKALAVIMAI EKSPLOATAVIMUI **ET** ÜLDISED HOIATUSED KASUTAMISEKS **LV** VISPĀRĒJIE DROŠĪBAS NOTEIKUMI LIETOŠANAS LAIKĀ **BG** ОБЩА БЕЗОПАСНОСТ ПРИ УПОТРЕБА **PL** OGÓLNE BEZPIECZEŃSTWO PODCZAS UŻYTKOWANIA **AR** السلامة العامة للاستخدام



(EN)	EXPLANATION OF DANGER, MANDATORY AND PROHIBITION SIGNS.	(HU)	EN VERBOD.	(SL)	LEGENDA SIGNALOV ZA NEVARNOST, ZA PREDPISANO IN PREPOVEDANO.
(IT)	LEGENDA SEGNALI DI PERICOLO, D'OBBLIGO E DIVIETO.	(RO)	A VESZÉLY, KÖTELEZETTSÉG ÉS TILTÁS JELZÉSEINEK FELIRATAI.	(HR-SR)	LEGENDA OZNAKA OPASNOSTI, OBAVEZA I ZABRANA.
(FR)	LÉGENDE SIGNAUX DE DANGER, D'OBLIGATION ET D'INTERDICTION.	(SV)	LEGENDÅ INDICATOARE DE AVERTIZARE A PERICOLELOR, DE OBLIGARE ŞI DE INTERZICERE.	(LT)	PAVOJAUS, PRIVALOMŪJŲ IR DRAUDŽIAMŪJŲ ŽENKLŲ PAAIŠKINIMAS.
(ES)	LEYENDA SEÑALES DE PELIGRO, DE OBLIGACIÓN Y PROHIBICIÓN.	(DA)	BILDTXT SYMBOLER FÖR FARA, PÅBUD OCH FÖRBUD.	(ET)	OHUD, KOHUSTUSED JA KEELUD.
(DE)	LEGENDE DER GEFAHREN-, GEBOTS- UND VERBOTSZEICHEN.	(NO)	OVERSICHT OVER FARE, PLIGT OG FORBUDSSIGNALER.	(LV)	BĪSTAMĪBU, PIENĀKUMU UN AIZLIEGUMA ZĪMJŪ PASKAIDROJUMI.
(RU)	ЛЕГЕНДА СИМВОЛОВ БЕЗОПАСНОСТИ, ОБЯЗАННОСТИ И ЗАПРЕТА.	(BG)	SIGNALERINGSTEEKST FOR FARE, FORPLIKTELSER OG FORBUDT.	(PL)	LEGENDA NA ZNAČITE ZA OPASNOST, ZADŹLŻITELNI I ZA ZABRANA.
(PT)	LEGENDA DOS SINAIS DE PERIGO, OBRIGAÇÃO E PROIBIDO.	(FI)	VAROITUS, VELVOITUS, JA KIELTOMERKIT.	(AR)	مفاتيح رموز الخطر والإلزام والحظر.
(EL)	ΛΕΞΑΝΤΑ ΣΗΜΑΤΩΝ ΚΙΝΔΥΝΟΥ, ΥΠΟΧΡΕΩΣΗΣ ΚΑΙ ΑΠΑΓΟΡΕΥΣΗΣ.	(CS)	VYSVĚTLIVKY K SIGNÁLŮM NEBEZPEČÍ A PŘIKAZŮM A ZÁKAZŮM.		
(NL)	LEGENDE SIGNALLEN VAN GEVAAR, VERPLICHTING	(SK)	VYSVETLIVKY K SIGNÁLŮM NEBEZPEČENSTVA, PŘIKAZOM A ZÁKAZOM.		

	(EN) DANGER OF EXPLOSION - (IT) PERICOLO ESPLOSIONE - (FR) RISQUE D'EXPLOSION - (ES) PELIGRO EXPLOSIÓN - (DE) EXPLOSIONSGEFAHR - (RU) ОПАСНОСТЬ ВЗРЫВА - (PT) PERIGO DE EXPLOSIÃO - (EL) ΚΙΝΔΥΝΟΣ ΕΚΡΗΞΗΣ - (NL) GEVAAR ONTPLOFFING - (HU) ROBBANÁS VESZÉLYE - (RO) PERICOL DE EXPLOZIE - (SV) FARA FÖR EXPLOSION - (DA) SPRÆNGFARE - (NO) FARE FOR EKSPLOSJON - (FI) RÄJÄHDYSVAARA - (CS) NEBEZPEČÍ VÝBUCHU - (SK) NEBEZPEČENSTVO VÝBUCHU - (SL) NEVARNOST EKSPLOZIJE - (HR-SR) OPASNOST OD EKSPLOZIJE - (LT) SPROGIMO PAVOJUS - (ET) PLAHVATUSOHT - (LV) SPRĀDZIENBĪSTAMĪBA - (BG) ОПАСНОСТ ОТ ЕКСПЛОЗИЯ - (PL) NIEBEZPIECZEŃSTWO WYBUCHU - (AR) خطر الانفجار
	(EN) GENERAL HAZARD - (IT) PERICOLO GENERICO - (FR) DANGER GÉNÉRIQUE - (ES) PELIGRO GENÉRICO - (DE) GEFAHR ALLGEMEINER ART - (RU) ОБЩАЯ ОПАСНОСТЬ - (PT) PERIGO GERAL - (EL) ΓΕΝΙΚΟΣ ΚΙΝΔΥΝΟΣ - (NL) ALGEMEEN GEVAAR - (HU) ÁLTALÁNOS VESZÉLY - (RO) PERICOL GENERAL - (SV) ALLMÅN FARA - (DA) ALMEN FARE - (NO) GENERISK FARE STRÅLNING - (FI) YLEINEN VAARA - (CS) VŠEOBECNĚ NEBEZPEČÍ - (SK) VŠEOBECNÉ NEBEZPEČENSTVO - (SL) SPOŠNA NEVARNOST - (HR-SR) OPĆA OPASNOST - (LT) BENDRAS PAVOJUS - (ET) ÜLDINE OHT - (LV) VISPĀRĪGA BĪSTAMĪBA - (BG) ОБЩИ ОПАСНОСТИ - (PL) OGÓLNE NIEBEZPIECZEŃSTWO - (AR) خطر عام
	(EN) DANGER OF CORROSIVE SUBSTANCES - (IT) PERICOLO SOSTANZE CORROSIVE - (FR) SUBSTANCES CORROSIVES DANGEREUSES - (ES) PELIGRO SUSTANCIAS CORROSIVAS - (DE) ÄTZENDE GEFAHRENSTOFFE - (RU) ОПАСНОСТЬ КОРРОЗИВНЫХ ВЕЩЕСТВ - (PT) PERIGO SUBSTÂNCIAS CORROSIVAS - (EL) ΚΙΝΔΥΝΟΣ ΔΙΑΒΡΩΤΙΚΩΝ ΟΥΣΙΩΝ - (NL) GEVAAR CORROSIEVE STOFFEN - (HU) MÁRÓ HATÁSÚ ANYAGOK VESZÉLYE - (RO) PERICOL DE SUBSTANȚE COROSIVE - (SV) FARA FRÅTÄNDE ÄMNER - (DA) FARE, ÆTSENDE STOFFER - (NO) FARE: KORROSIVE SUBSTANSER - (FI) SYÖVYTTÄVIEN AINEIDEN VAARA - (CS) NEBEZPEČÍ PLYNOUCÍ Z KOROSIVNÍCH LÁTEK - (SK) NEBEZPEČENSTVO VYPŮLYVAJÚCE Z KORÓZIVNÝCH LÁTKO - (SL) NEVARNOST JEDKE SNOVI - (HR-SR) OPASNOST OD KOROZIVNIH TVARI - (LT) KOROZINIŲ MEDIŽIAGŲ PAVOJUS - (ET) KORRUDEERUVATE MATERIAALIDE OHT - (LV) KORŪZIJAS VIELU BĪSTAMĪBA - (BG) ОПАСНОСТ ОТ КОРОЗИВНИ ВЕЩЕСТВА - (PL) NIEBEZPIECZEŃSTWO WYDZIAŁANIA SUBSTANCJI KORÓZYJNYCH - (AR) خطر المواد المسببة للتآكل
	(EN) DANGER OF ELECTRIC SHOCK - (IT) PERICOLO SHOCK ELETTRICO - (FR) RISQUE DE CHOC ÉLECTRIQUE - (ES) PELIGRO DESCARGA ELÉCTRICA - (DE) STROMSCHLAGEGEFAHR - (RU) ОПАСНОСТЬ ПОРАЖЕНИЯ ЭЛЕКТРИЧЕСКИМ ТОКОМ - (PT) PERIGO DE CHOQUE ELÉTRICO - (EL) ΚΙΝΔΥΝΟΣ ΗΛΕΚΤΡΟΠΛΗΞΙΑΣ - (NL) GEVAAR ELEKTROSHOCK - (HU) ÁRAMTŰS VESZÉLYE - (RO) PERICOL DE ELECTROCUTARE - (SV) FARA FÖR ELEKTRISK STÖT - (DA) FARE FOR ELEKTRISK STØD - (NO) FARE FOR ELEKTRISK STØT - (FI) SÄHKÖISKUN VAARA - (CS) NEBEZPEČÍ ZÁSAHU ELEKTRICKÝM PROUDEM - (SK) NEBEZPEČENSTVO ZÁSAHU ELEKTRICKÝM PRŮDOM - (SL) NEVARNOST ELEKTRIČNEGA UDARA - (HR-SR) OPASNOST STRUJNOG UDARA - (LT) ELEKTROS SMŪGIO PAVOJUS - (ET) ELEKTRILÕÕGIOHT - (LV) ELEKTROŠOKA BĪSTAMĪBA - (BG) ОПАСНОСТ ОТ ТОКОВ УДАР - (PL) NIEBEZPIECZEŃSTWO SZOKU ELEKTRYCZNEGO - (AR) خطر الصدمة الكهربائية
	(EN) EYE PROTECTIONS MUST BE WORN - (IT) OBBLIGO DI INDOSSARE OCCHIALI PROTETTIVI - (FR) PORT DES LUNETTES DE PROTECTION OBLIGATOIRE - (ES) OBLIGACIÓN DE USAR GAFAS DE PROTECCIÓN - (DE) DAS TRAGEN EINER SCHUTZBRILLE IST PFLICHT - (RU) ОБЯЗАТЕЛЬНО НОСИТЬ ЗАЩИТНЫЕ ОЧКИ - (PT) OBRIGAÇÃO DE VESTIR ÓCULOS DE PROTECÇÃO - (EL) ΥΠΟΧΡΕΩΣΗ ΝΑ ΦΟΡΑΤΕ ΠΡΟΣΤΗΤΕΥΤΙΚΑ ΓΥΑΛΙΑ - (NL) VERPLICHT DRAGEN VAN BESCHERMENDE BRIL - (HU) VÉDŐSZEMÉLVÉG VISELETE KÖTELEZŐ - (RO) ESTE OBLIGATORIE PURTAREA OCHELARILOR DE PROTECȚIE - (SV) OBLIGATORISKT ATT ANVÄNDA SKYDDSGLASÖGON - (DA) PLIGT TIL AT ANVENDE BESKYTTELSERBRILLER - (NO) DET ER OBLIGATORISK Å HA PÅ SEG VERNEBRILLER - (FI) SUOJALASIAN KÄYTTÖ PAKOLLISTA - (CS) POVINNOST POUŽÍVÁNÍ OCHRANNÝCH BRÝLÍ - (SK) POVINNOST POUŽÍVANIA OCHRANNÝCH OKULIAROV - (SL) OBEZNA UPORABA ZAŠČITNIH OČAL - (HR-SR) OBAVEZNA UPOTREBA ZAŠTITNIH NAOČALA - (LT) PRIVALOMA DIRBTI SU APSAUGINIAIS AKINIAMS - (ET) KOHUSTUS KANDA KAITSEPRILLE - (LV) PIENĀKUMS VILKT AIZSARGBRILLES - (BG) ЗАДЪЛЖИТЕЛНО ДА СЕ НОСЯТ ПРЕДПАЗНИ ОЧИЛА - (PL) NAKAZ NOSZENIA OKULARÓW OCHRONNYCH - (AR) الإلزام بارتداء نظارات واقية



(EN) WEARING PROTECTIVE CLOTHING IS COMPULSORY - (IT) OBBLIGO INDOSSARE INDUMENTI PROTETTIVI - (FR) PORT DES VÊTEMENTS DE PROTECTION OBLIGATOIRE - (ES) OBLIGACIÓN DE LLEVAR ROPA DE PROTECCIÓN - (DE) DAS TRAGEN VON SCHUTZKLEIDUNG IST PFLICHT - (RU) ОБЯЗАТЕЛЬНОСТЬ НАДЕВАТЬ ЗАЩИТНУЮ ОДЕЖДУ - (PT) OBRIGATORIO O USO DE VESTUÁRIO DE PROTEÇÃO - (EL) ΥΠΟΧΡΕΩΣΗ ΝΑ ΦΟΡΑΤΕ ΠΡΟΤΕΛΤΑΥΤΙΚΑ ΕΝΔΥΜΑΤΑ - (NL) VERPLICHT BESCHERMENDE KLEDIJ TE DRAGEN - (HU) VÉDŐRŰHA HASZNÁLATA KÖTELEZŐ - (RO) FOLOSIREA ÎMBRĂCĂMIŢEI DE PROTECŢIE OBLIGATORIE - (SV) OBLIGATORISKT ATT BÄRA SKYDDSPLAG - (DA) PLIGT TIL AT ANVENDE BESKYTTELSESTØJ - (NO) FORPLIKTELSE Å BRUKE VERNETØY - (FI) SUOJAVAAETUKSEN KÄYTTÖ PAKOLLISTA - (CS) POVINNÉ POUŽITÍ OCHRANNÝCH PROSTŘEDKŮ - (SK) POVINNÉ POUŽITIE OCHRANNÝCH PROSTRIEDKOV - (SL) OBEZNA OBLECITE ZAŠČITNA OBLAČILA - (HR-SR) OBLAVEZNO KORIŠTENJE ZAŠTITNE ODUJE - (LT) PRIVALOMA DĖVINTI APSAUGINE APRANGA - (ET) KOHUSTUSLIK KANDA KAITSERIETUST - (LV) PIENĀKUMS ĢĒRBT AIZSARGTĒRPUS - (BG) ЗАДЪЛЖИТЕЛНО НОСЕНЕ НА ПРЕДПАЗНО ОБЛЕКЛО - (PL) NAKAZ NOSZENIA ODZIEŻY OCHRONNEJ - (AR) الالتزام بارتداء الملابس الواقية



(EN) Symbol indicating separation of electrical and electronic appliances for refuse collection. The user is not allowed to dispose of these appliances as solid, mixed urban refuse, and must do it through authorised refuse collection centres. - (IT) Simbolo che indica la raccolta separata delle apparecchiature elettriche ed elettroniche. L'utente ha l'obbligo di non smaltire questa apparecchiatura come rifiuto municipale solido misto, ma di rivolgersi ai centri di raccolta autorizzati. - (FR) Symbole indiquant la collecte différenciée des appareils électriques et électroniques. L'utilisateur ne peut éliminer ces appareils avec les déchets ménagers solides mixtes, mais doit s'adresser à un centre de collecte autorisé. - (ES) Símbolo que indica la recogida por separado de los aparatos eléctricos y electrónicos. El usuario tiene la obligación de no eliminar este aparato como desecho urbano sólido mixto, sino de dirigirse a los centros de recogida autorizados. - (DE) Symbol für die getrennte Erfassung elektrischer und elektronischer Geräte. Der Benutzer hat pflichtgemäß dafür zu sorgen, daß dieses Gerät nicht mit dem gemischt erfaßten festen Siedlungsabfall entsorgt wird. Stattdessen muß er eine der autorisierten Entsorgungsstellen einschalten. - (RU) Символ, указывающий на отдельный сбор электрического и электронного оборудования. Пользователь не имеет права выбрасывать данное оборудование в качестве смешанного твердого бытового отхода, а обязан обращаться в специализированные центры сбора отходов. - (PT) Símbolo que indica a reunião separada das aparelhagens eléctricas e electrónicas. O utente tem a obrigação de não eliminar esta aparelhagem como lixo municipal sólido misto, mas deve procurar os centros de recolha autorizados. - (EL) Σύμβολο που δείχνει τη διαφορετικοποιημένη συλλογή των ηλεκτρικών και ηλεκτρονικών συσκευών. Ο χρήστης υποχρεούται να μην διοχετεύει αυτή τη συσκευή σαν μικτό στερεό αστικό απόβλητο, αλλά να απευθύνεται σε ειδικευμένα κέντρα συλλογής. - (NL) Symbol dat wijst op de gescheiden inzameling van elektrische en elektronische toestellen. De gebruiker is verplicht deze toestellen niet te lozen als gemengde vaste stadsafval, maar moet zich wenden tot de geautoriseerde ophaalcentra. - (HU) Jelölés, mely az elektromos és elektronikus felszerelések szelektív hulladékgyűjtését jelzi. A felhasználó köteles ezt a felszerelést nem a városi törmelék hulladékkal együttesen gyűjteni, hanem erre engedéllyel rendelkező hulladékgyűjtő központhoz fordulni. - (RO) Simbol ce indică depozitarea separată a aparaturilor electrice și electronice. Utilizatorul este obligat să nu depoziteze acest aparat împreună cu deșeurile solide mixte ci să-l predea într-un centru de depozitare a deșeurilor autorizat. - (SV) Symbol som indikerar separat sopsortering av elektriska och elektroniska apparater. Användaren får inte sortera denna anordning tillsammans med blandat fast hushållsavfall, utan måste vända sig till en auktoriserad insamlingsstation. - (DA) Symbol, der står for særlig indsamling af elektriske og elektroniske apparater. Brugeren har pligt til ikke at bortskaffe dette apparat som blandet, fast byaffald; der skal rettes henvendelse til et autoriseret indsamlingscenter. - (NO) Symbol som angir separat sortering av elektriske og elektroniske apparater. Brukeren må oppfylle forpliktelserne til ikke kaste bort dette apparatet sammen med vanlige hjemmeavfallet, uten henvende seg til autoriserte oppsamlingsstasjoner. - (FI) Symboli, joka ilmoittaa sähkö- ja elektroniikkalaitteiden erillisen keräyksen. Käyttäjän velvollisuus on kääntäy valtuutettujen keräyspisteiden puoleen eikä välittää laitetta kunnallisenä sekajätteenä. - (CS) Symbol označující separovaný sběr elektrických a elektronických zařízení. Uživatel je povinen nezlíkovidovat toto zařízení jako pevný smíšený komunální odpad, ale obrátit se s ním na autorizovaný sběrný. - (SK) Symbol označujúci separovaný zber elektrických a elektronických zariadení. Užívateľ nesmie likvidovať toto zariadenie ako pevný zmiešaný komunálny odpad, ale je povinný doručiť ho do autorizovaný zberní. - (SL) Simbol, ki označuje ločeno zbiranje električnih in elektronskih aparatov. Uporabnik tega aparata ne sme zavreči kot navaden gospodinjški trden odpad, ampak se mora obrniti na pooblašene centre za zbiranje. - (HR-SR) Simbol koji označava posebno sakupljanje električnih i elektronskih aparata. Korisnik ne smije odložiti ovaj aparat kao običan kruti otpad, već se mora obratiti ovlaštenim centrima za sakupljanje. - (LT) Simbolis, nurodantis atskirų nebenaudojamų elektrinių ir elektroninių prietaisų surinkimą. Vartotojas negali išmesti šių prietaisų kaip mišrių kietųjų komunalinių atliekų, bet privalo kreiptis į specializuotus atliekų surinkimo centrus. - (ET) Sümbol, mis tähistab elektrija elektronikaseadmete eraldi kogumist. Kasutaja kohustuseks on pööruda volitatud kogumiskeskuste poole ja mitte käsitleda seda aparati kui munitsipaalne segajäade. - (LV) Simbols, kas norāda uz to, ka utilizācija ir jāveic atsevišķi no citām elektriskajām un elektroniskajām ierīcēm. Lietotāja pienākums ir neizmet šo aparāturu municipālajā cieto atkritumu izgāzuvē, bet nogādāt to pilnvarotajā atkritumu savākšanas centrā. - (BG) Символ, който означава разделно събиране на електрическата и електронна апаратура. Ползвателят се задължава да не изхвърля тази апаратура като смесен твърд отпадък в контейнерите за смет, поставени от общината, а трябва да се обърне към специализираните за това центрове. - (PL) Symbol, który oznacza sortowanie odpadów aparatury elektrycznej i elektronicznej. Zabrania się likwidowania aparatury jako mieszanych odpadów miejskich stałych, obowiązkiem użytkownika jest skierowanie się do autoryzowanych ośrodków gromadzących odpady - (AR) رمز يشير إلى التجميع المنفصل للأجهزة الكهربائية والإلكترونية. يجب على المستخدم عدم التخلص من هذا الجهاز وكأنه نفايات البلدية الصلبة المختلطة، بل عليه التوجه إلى مراكز تجميع النفايات المُصرح بها



WARNING: BEFORE USING THE BATTERY CHARGER READ THE INSTRUCTION MANUAL CAREFULLY.

1. GENERAL SAFETY RULES FOR THE USE



- Avoid contact with battery acid. Should an operator be sprayed or come into contact with the acid, rinse the relative parts immediately under clean running water. Continue to rinse the area until the physician arrives.



- During the charge the battery produces explosive gases, avoid the formation of flames and sparks. **DO NOT SMOKE.**
- Position the batteries to be charged in a well-ventilated place.



- Protect the eyes. Always wear protective goggles when using acid lead accumulators.



- Always wear suitable clothing. Never wear baggy clothing or jewellery that can get caught up in moving parts. During all operations, electrically insulated protection clothing and non-slip boots must be worn at all times. Persons with long hair must tie it back and wear a hair net.



- Inexperience and untrained people should be properly instructed before using the appliance.
- This appliance can be used by children aged from 8 years and above and persons with reduced physical, sensory or mental capabilities or lack of experience and knowledge if they have been given supervision or instruction concerning use of the appliance in a safe way and understand the hazards involved.
- Children shall not play with the appliance.
- Cleaning and user maintenance shall not be made by children without supervision.
- Use the battery charger only indoors and make sure that you start it in airy places. **DO NOT SET IN THE RAIN OR SNOW.**
- Disconnect the mains cable before connecting to or disconnecting the charging cables from the battery.
- Do not connect or disconnect the clamps to or from the battery with the battery charger operating.
- Never use the battery charger inside the car or in the bonnet.
- Substitute the mains cable only with an original one.
- If the supply cord is damaged, it must be replaced by the manufacturer, its service agent or similarly qualified persons in order to avoid a hazard.
- Do not use the battery charger to charge batteries which are not rechargeable.
- Make sure the available power supply voltage corresponds to that shown on the battery charger rating plate.
- To prevent damaging the vehicle electronics, scrupulously respect the warnings given by the producer of the vehicle or the batteries used.
- This battery charger has components such as switches and relays which can cause arcs or sparks. Therefore when using it in a garage or in a similar place set the battery charger in a suitable case.
- Repair or maintenance of the inside of the battery charger can be executed only by skilled technicians.
- **WARNING: ALWAYS DISCONNECT THE POWER SUPPLY CABLE FROM THE MAINS BEFORE CARRYING OUT ANY SIMPLE MAINTENANCE OPERATION ON THE BATTERY CHARGER.**
- The battery charger is protected from indirect contact by an earth wire as indicated for class I equipment. Make sure the power outlet is protected by an earth connection.

- In models without this element, connect plugs of appropriate capacity, not below the fuse value indicated on the rating plate.



- Class A device:

This battery charger complies with the requirements of the technical standard for products to be used in industrial environments and for professional purposes. No compliance with the electromagnetic compatibility in domestic use buildings is guaranteed and those connected directly to a low voltage power supply network that furnishes buildings designated to domestic use.

2. GENERAL DESCRIPTION

Battery charger indicated for charging WET, EFB, GEL, AGM + (Ca) lead batteries and Li lithium batteries used by motorised vehicles (petrol and diesel) and electric vehicles: automobiles, motor vehicles, motorcycles, boats, etc. It is possible to charge 12V and 24V batteries; there is also a starter aid mode (for vehicles with petrol and diesel engines only). Rechargeable accumulators according to the output voltage available: 12V / 6 cells; 24V / 12 cells.

3. INSTALLATION

ASSEMBLY

- Unpack the battery charger and assemble the separate parts contained in the package.
- Models on wheels are to be set in a vertical position.

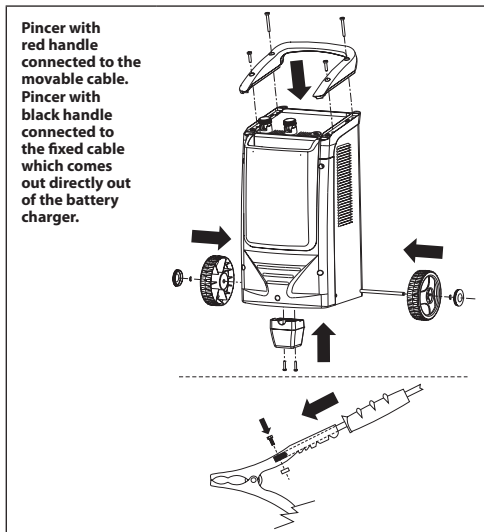

3.1 BATTERY CHARGER POSITION

When running, position the battery charger in a stable position and make sure the air flow through the openings which guarantee required ventilation is not blocked.

3.2 CONNECTION TO THE MAINS

- The battery charger must only be connected to a power supply system with neutral conductor connected to earth.
- Check that the mains voltage is the same as the battery charger voltage indicated on the rating plate.
- The power line must have a protection system, such as fuses or circuit breakers, that can support the maximum apparatus absorption.
- Use the relative power cable when connecting to the mains.
- Any power cable extensions must be of suitable section size, never lower than that of the supplied power cable.
- It is always compulsory to connect the device to the grounding system, using the yellow-green wire in the power cable identified with the label (PE), whilst the other two wires must be connected to the phase and neutral conductors on the mains power supply.

4. OPERATING DURING CHARGING

N.B.: Before charging, make sure the capacity (Ah) of the battery to be charged is not lower than that indicated on the battery charger rating plate (Cmin). Follow the instructions scrupulously in the order

given below.

4.1 BATTERY PREPARATION

If the battery to be charged is the WET type, the procedure is as follows:

- Remove the battery caps (if present), so that the gas produced during charging can exit. Make sure the level of electrolyte covers the battery plates; if they are not covered, add distilled water until they are submerged by 5-10 mm.



ATTENTION! BE VERY CAREFUL WHILE CARRYING OUT THIS OPERATION BECAUSE THE ELECTROLYTE IS AN EXTREMELY CORROSIVE ACID.

4.2 BATTERY CHARGER/BATTERY CONNECTION

- Make sure the power cable is disconnected from the mains.
 - With models having more than one charge voltage, turn the deviator or the switch to the selected charge voltage. If there is no deviator or switch, suitably connect the red crocodile clip (+ symbol) to the specific battery charger terminal in correspondence with the selected charge voltage.
 - Connect the red charge clamp to the positive terminal of the battery (+ symbol). If the symbols are indistinguishable remember that the positive terminal is the one not connected to the vehicle chassis.
 - Connect the black charge clamp to the vehicle chassis, at a safe distance from the battery and the fuel pipe.
- NOTE:** if the battery is not installed in the vehicle, connect the clamp directly to the negative terminal of the battery (- symbol).

4.3 SIMULTANEOUS CHARGING OF MULTIPLE BATTERIES

WARNING: do not charge batteries of different capacities, discharges or types. When simultaneous charging is required, it is possible to use "series" or "parallel" connections:

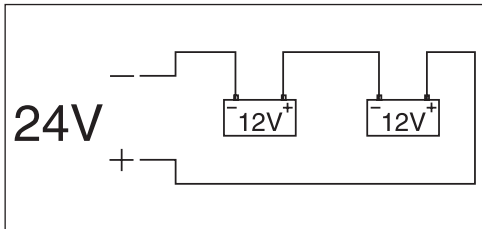

parallel

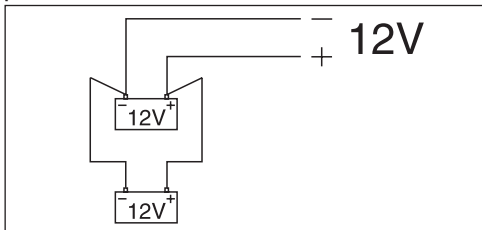

For "parallel" connections the batteries must have the same rated voltage (Volt), corresponding to that supplied by the battery charger and the total of the Ah must fall within the charge range of the battery charger.

For "series" connections the batteries must have the same capacity (Ah), and the total of the rated voltage of all the batteries must correspond to the output rated voltage supplied by the battery charger.

4.4. CHARGE ENDING

- Disconnect the battery charger by removing the power cable from the mains socket.
- Disconnect the black charge clamps from the vehicle chassis or from the negative battery terminal (- symbol).
- Disconnect the red charging clamp from the positive battery terminal (+ symbol).
- Return the battery charger to a dry place.
- Close the battery cells again, using the relative caps (if present).

5. STARTER MODE

ATTENTION: Before proceeding, read the vehicle manufacturers instructions carefully!

- Make sure the power line is protected by fuses or automatic circuit-breakers with sizes as indicated on the rating plate by the symbol ().

- To make the starting process easier, quick charge the battery for 10-15 minutes, with the battery charger in charge and NOT starter position.
- If the vehicle does not start, wait a few minutes and then repeat the rapid charge operation. Do not insist further if the vehicle motor does not start; this could cause serious damage to the battery or even to the electrical equipment in the vehicle.

5.1 BATTERY CHARGER/BATTERY CONNECTION

- Check before starting the vehicle that the battery nominal voltage corresponds to the value indicated on the battery charger.
- Make sure the battery is connected properly to the respective (+ and -) terminals, that the battery connections are correct and the battery is in good condition (not sulphated or dead).
- Never ever start vehicles with the batteries disconnected from their respective terminals; the presence of the battery is essential for the elimination of possible overvoltage that may be generated due to energy accumulating in the connection cables at the starting stage. **Failure to comply with these instructions can cause damage to the vehicle electronic system.**

5.2 STARTER

- To select this function, please refer to "STARTER" illustration.

5.3. STARTING COMPLETED

- Disconnect the power cable plug from the mains socket.
- Disconnect the black charge clamp from the negative battery terminal (- symbol) and the red clamp from the positive battery terminal (+ symbol).
- Return the battery charger to a dry place.

6. BATTERY CHARGER PROTECTION

The battery charger protects itself from:

- Overcharge (too much current supplied to the battery).
- Short-circuit (loading clips placed in contact with each other).
- Polarity inversion on the battery clamps.

For appliances fitted with fuses, if the fuses have to be replaced always use the same kind of fuse with the same rated size.



WARNING: If the replacement fuse has a different size from that shown on the rating plate it could cause damage to people or property. For the same reason, never ever replace the fuse with a bridge in copper or other material.

The power supply cable should always be DISCONNECTED from the mains supply while the fuse is being changed.

When replacing the ribbon fuse, if present, carefully fasten the nuts.

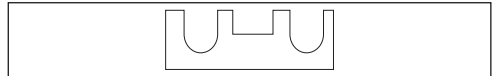

7. USEFUL ADVICE:

- Clean the positive and negative terminals from possible oxide deposits to guarantee good clamp contact.
- If the battery to be recharged using this apparatus is permanently fitted inside the vehicle, consult the "ELECTRIC SYSTEM" or "MAINTENANCE" sections of the vehicle instruction and/or maintenance manual.



"E' possibile scaricare la documentazione in formato pdf, all'indirizzo: www.telwin.com/usermanual".



ATTENZIONE: PRIMA DI UTILIZZARE IL CARICABATTERIE LEGGERE ATTENTAMENTE IL MANUALE D'ISTRUZIONE!

1. SICUREZZA GENERALE PER L'USO



- Evitare il contatto con l'acido della batteria. Nel caso si venga schizzati o si venga a contatto con l'acido, risciacquare immediatamente la parte interessata con acqua pulita. Continuare a risciacquare fino all'arrivo del medico.



- Durante la carica le batterie emanano gas esplosivi, evitate che si formino fiamme e scintille. **NON FUMARE.**
- Posizionare le batterie in carica in un luogo areato.



- Proteggere gli occhi. Indossare sempre occhiali protettivi quando si lavora con accumulatori al piombo acido.



- Vestirsi in maniera appropriata. Non indossare abiti larghi o gioielli che possano impigliarsi in parti mobili. Durante i lavori si raccomanda l'uso di abiti protettivi isolati elettricamente nonché di calzature antidrucciolo. Nel caso di capigliatura lunga indossare copricapo contenitivi.



- Le persone inesperte devono essere opportunamente istruite prima di utilizzare l'apparecchio.
- L'apparecchio può essere utilizzato da bambini di età non inferiore a 8 anni e da persone con ridotte capacità fisiche, sensoriali o mentali, o prive di esperienza o della necessaria conoscenza, purché sotto sorveglianza oppure dopo che le stesse abbiano ricevuto istruzioni relative all'uso sicuro dell'apparecchio e alla comprensione dei pericoli ad esso inerenti.
- I bambini non devono giocare con l'apparecchio.
- La pulizia e la manutenzione destinata ad essere effettuata dall'utilizzatore non deve essere effettuata da bambini senza sorveglianza.
- Usare il caricabatterie esclusivamente all'interno e in ambienti ben areati: **NON ESPORRE A PIOGGIA O NEVE.**
- Disinserire il cavo di alimentazione dalla rete prima di connettere o sconnettere i cavi di carica dalla batteria.
- Non collegare né scollegare le pinze alla batteria con il caricabatterie funzionante.
- Non usare nel modo più assoluto il caricabatterie all'interno di un'autovettura o del cofano.
- Sostituire il cavo di alimentazione solo con un cavo originale.
- Se il cavo di alimentazione è danneggiato, esso deve essere sostituito dal costruttore o dal suo servizio assistenza tecnica o comunque da una persona con qualifica simile, in modo da prevenire ogni rischio.
- Non utilizzare il caricabatterie per ricaricare batterie di tipo non ricaricabili.
- Verificare che la tensione di alimentazione disponibile sia corrispondente a quella indicata sulla targa dati del caricabatterie.
- Per non danneggiare l'elettronica dei veicoli, rispettare scrupolosamente le avvertenze fornite dai costruttori dei veicoli o delle batterie utilizzate.
- Questo caricabatterie comprende parti, quali interruttori o relé che possono provocare archi o scintille; pertanto se usato in una autorimessa o in un ambiente simile, porre il caricabatterie in un locale o in una custodia adatta allo scopo.
- Interventi di riparazione o manutenzione all'interno del caricabatterie devono essere eseguiti solo da personale esperto.
- **ATTENZIONE: DISINSERIRE SEMPRE IL CAVO DI ALIMENTAZIONE**

DALLA RETE PRIMA DI EFFETTUARE QUALSIASI INTERVENTO DI SEMPLICE MANUTENZIONE DEL CARICABATTERIE, PERICOLO!

- Il caricabatterie è protetto da contatti indiretti mediante un conduttore di terra come prescritto per gli apparecchi di classe I. Controllare che la presa sia provvista di collegamento di terra di protezione.
- Nei modelli che ne sono sprovvisti, collegare spine di portata appropriata, non inferiore, al valore del fusibile indicato in targa dati.



- **Apparecchiatura di classe A:**

Questo caricabatterie soddisfa i requisiti dello standard tecnico di prodotto per l'uso in ambiente industriale e a scopo professionale. Non è assicurata la rispondenza alla compatibilità elettromagnetica negli edifici domestici e in quelli direttamente collegati a una rete di alimentazione a bassa tensione che alimenta gli edifici per l'uso domestico.

2. DESCRIZIONE GENERALE

Caricabatterie indicato per la carica di batterie al piombo WET, EFB, GEL, AGM + (Ca) e batterie litio Li utilizzate su veicoli a motore (benzina e diesel) e veicoli elettrici: automobili, motoveicoli, motocicli, imbarcazioni, ecc.. E' possibile ricaricare batterie da 12V, 24V; è prevista anche la modalità avviamento (solo per i veicoli con motori a benzina e diesel). Accumulatori ricaricabili in funzione della tensione di uscita disponibile: 12V / 6 celle; 24V / 12 celle.

3. INSTALLAZIONE ALLESTIMENTO

- Disimballare il caricabatterie, eseguire il montaggio delle parti staccate, contenute nell'imballo.
- I modelli carrellati vanno installati in posizione verticale.

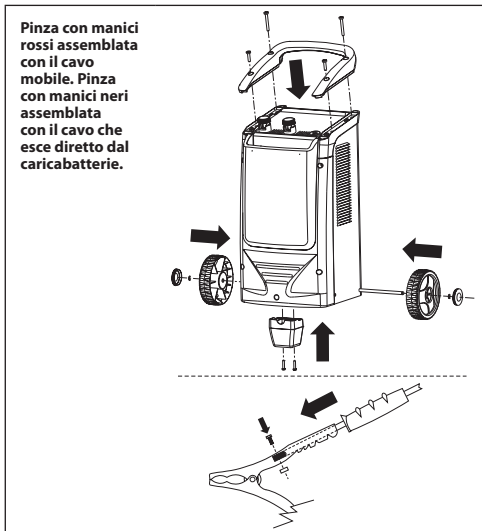

3.1 UBICAZIONE DEL CARICABATTERIE

Durante il funzionamento, posizionare in modo stabile il caricabatterie ed assicurarsi di non ostruire il passaggio d'aria attraverso le apposite aperture garantendo così una sufficiente ventilazione.

3.2 COLLEGAMENTO ALLA RETE ELETTRICA

- Il caricabatterie deve essere collegato esclusivamente ad un sistema di alimentazione con conduttore di neutro collegato a terra.
- Controllare che la tensione della rete elettrica corrisponda alla tensione di funzionamento del caricabatterie, riportata in targa dati.
- La linea di alimentazione dovrà essere dotata di sistemi di protezione, quali fusibili o interruttori automatici, sufficienti per sopportare l'assorbimento massimo dell'apparecchio.
- Il collegamento alla rete elettrica è da effettuarsi con apposito cavo di alimentazione.
- Eventuali prolunghes del cavo di alimentazione devono avere una sezione adeguata e comunque mai inferiore a quella del cavo di

alimentazione dell'apparecchio.

- E' sempre obbligatorio collegare a terra l'apparecchio, utilizzando il conduttore di colore giallo-verde del cavo di alimentazione, contraddistinto dall'etichetta (↓), mentre gli altri due conduttori andranno collegati alla fase e al neutro delle rete elettrica di distribuzione.

4. FUNZIONAMENTO IN CARICA

NB: Prima di procedere alla carica, verificare che la capacità della batteria (Ah) che si intende sottoporre a carica non sia inferiore a quella indicata nella targa dati dei caricabatterie (Cmin). Eseguire le istruzioni seguendo scrupolosamente l'ordine sotto riportato.

4.1 PREPARAZIONE BATTERIA

Se la batteria da ricaricare è di tipo WET procedere come segue:

- Rimuovere i tappi della batteria (se presenti), così che i gas che si producono durante la carica possano fuoriuscire. Controllare che il livello dell'elettrolita ricopra le piastre della batteria; se queste risultassero scoperte aggiungere acqua distillata fino a sommergerle di 5 - 10mm.



ATTENZIONE! PRESTARE LA MASSIMA CAUTELA DURANTE QUESTA OPERAZIONE IN QUANTO L'ELETTROLITA E' UN ACIDO ALTAMENTE CORROSIVO.

4.2 COLLEGAMENTO CARICABATTERIE/BATTERIA

- Verificare che il cavo di alimentazione sia scollegato dalla presa di rete.
- Per i modelli con più tensioni di carica posizionare il deviatore o il commutatore in corrispondenza della tensione di carica prescelta. In assenza di deviatore o commutatore, collegare opportunamente il cavo con pinza di carica rossa (simbolo +) allo specifico morsetto del caricabatterie in corrispondenza della tensione di carica prescelta.
- Collegare la pinza di carica di colore rosso al morsetto positivo della batteria (simbolo +). Se i simboli non si distinguono si ricorda che il morsetto positivo è quello non collegato al telaio della macchina.
- Collegare la pinza di carica di colore nero al telaio della macchina, lontano dalla batteria e dal condotto del carburante.

NOTA: se la batteria non è installata in macchina, collegarsi direttamente al morsetto negativo della batteria (simbolo -).

4.3 CARICA SIMULTANEA DI PIU' BATTERIE

ATTENZIONE: non caricare batterie di capacità, scarica e tipologia diverse tra loro. Dovendo caricare più batterie contemporaneamente si può ricorrere a dei collegamenti in "serie" o "parallelo":

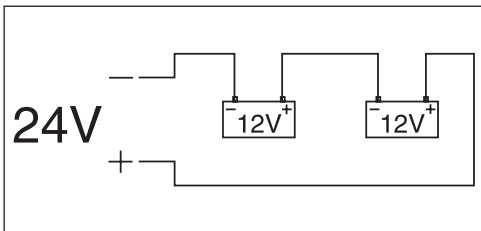

parallelo

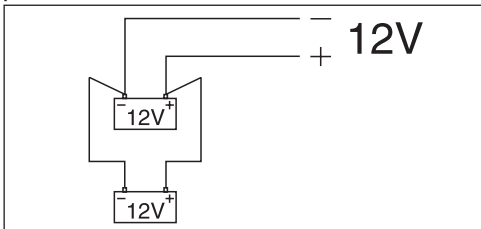

Il collegamento in "parallelo" richiede che le batterie abbiano la stessa tensione nominale (Volt), corrispondente a quella in uscita dal caricabatterie e che la somma degli Ah sia compresa nella gamma di carica del caricabatterie.

Il collegamento in "serie" richiede che le batterie abbiano la stessa capacità (Ah) e che la somma delle tensioni nominali di tutte le batterie sia corrispondente a quella in uscita dal caricabatterie.

4.4 FINE CARICA

- Togliere l'alimentazione al caricabatterie sfilando la spina del cavo di alimentazione dalla presa di rete elettrica.

- Scollegare la pinza di carica di colore nero dal telaio del veicolo o dal morsetto negativo della batteria (simbolo -).
- Scollegare la pinza di carica di colore rosso dal morsetto positivo della batteria (simbolo +).
- Riporre il caricabatterie in luogo asciutto.
- Richiudere le celle della batteria con gli appositi tappi (se presenti).

5. FUNZIONAMENTO IN AVVIAMENTO

ATTENZIONE: prima di procedere osservare attentamente le avvertenze dei costruttori dei veicoli!

- Assicurarsi di proteggere la linea di alimentazione con fusibili o interruttori automatici del valore corrispondente indicato in targa dati con il simbolo (—|—).
- Per facilitare l'avviamento, eseguire preventivamente una carica rapida di 10-15 minuti, con caricabatterie in posizione di carica e NON di avviamento.
- Se il veicolo non si avvia, attendere qualche minuto e ripetere l'operazione di carica rapida. Non insistere oltre se il motore del veicolo non si avvia; si potrebbe, infatti, compromettere seriamente la batteria o addirittura l'equipaggiamento elettrico del veicolo.

5.1 COLLEGAMENTO CARICABATTERIE/BATTERIA

- Accertarsi prima di procedere con l'avviamento del veicolo che il valore di tensione nominale della batteria corrisponda al valore impostato nel caricabatterie.
- Accertarsi che la batteria sia ben collegata ai rispettivi morsetti (+ e -) che i collegamenti verso batteria siano corretti e che la batteria sia in buono stato (non solfata e non guasta).
- Non eseguire nel modo più assoluto avviamenti di veicoli con batterie scollegate dai rispettivi morsetti; la presenza della batteria è determinante per l'eliminazione di eventuali sovratensioni per effetto dell'energia che si potrebbe accumulare nei cavi di collegamento durante le fasi di avviamento. **La non osservanza di queste disposizioni può danneggiare l'elettronica del veicolo.**

5.2 AVVIAMENTO

- Per la selezione di questa funzione, vedere l'illustrazione "AVVIAMENTO".

5.3 FINE AVVIAMENTO

- Togliere la spina del cavo di alimentazione dalla presa della rete di alimentazione.
- Scollegare la pinza di carica di colore nero dal morsetto negativo della batteria (simbolo -) e quella di colore rosso dal morsetto positivo della batteria (simbolo +).
- Riporre il caricabatterie in luogo asciutto.

6. PROTEZIONI DEL CARICABATTERIE

Il caricabatterie si autoprottegge in caso di:

- Sovraccarico (eccessiva erogazione di corrente verso la batteria).
- Cortocircuito (pinze di carica messe a contatto fra di loro).
- Inversione di polarità sui morsetti della batteria.

Negli apparecchi muniti di fusibili è obbligatorio in caso di sostituzione, usare ricambi analoghi aventi lo stesso valore di corrente nominale.



ATTENZIONE: Sostituire il fusibile con valori di corrente diversi da quelli indicati in targa potrebbe provocare danni a persone o cose. Per lo stesso motivo, evitare nel modo più assoluto la sostituzione del fusibile con ponti di rame o altro materiale. L'operazione di sostituzione del fusibile va sempre eseguita con il cavo di alimentazione STACCATO dalla rete. Prestare attenzione durante la sostituzione del fusibile a nastro, ove presente, e serrare saldamente i dadi di fissaggio.

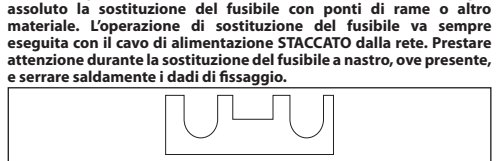

7. CONSIGLI UTILI

- Pulire i morsetti positivo e negativo da possibili incrostazioni di ossido in modo da assicurare il buon contatto delle pinze.
- Se la batteria sulla quale si intende utilizzare questo caricabatterie è permanentemente inserita sul veicolo, consultare anche il manuale d'istruzioni e/o di manutenzione del veicolo alla voce "IMPIANTO ELETTRICO" o "MANUTENZIONE".



ATTENTION: LIRE ATTENTIVEMENT LE MANUEL D'INSTRUCTIONS AVANT TOUTE UTILISATION DU CHARGEUR DE BATTERIE !

1. INSTRUCTIONS GÉNÉRALES DE SÉCURITÉ POUR L'UTILISATION



- Éviter le contact avec l'acide de la batterie. En cas d'éclaboussures ou de contact avec l'acide, rincer immédiatement la partie concernée avec de l'eau propre. Continuer à rincer jusqu'à l'arrivée du médecin.



- Les batteries dégagent des gaz explosifs durant la charge, éviter toute flamme ou étincelle, **NE PAS FUMER**.
- Positionner les batteries sous charge dans un endroit aéré.



- Protéger les yeux. Toujours porter des lunettes de protection quand on travaille avec des accumulateurs au plomb acide.



- S'habiller de façon appropriée. Ne pas porter de vêtements larges ou de bijoux qui pourraient rester accrochés dans les parties mobiles. Durant les travaux, nous recommandons d'utiliser des vêtements de protection isolés électriquement ainsi que des chaussures antidérapantes. En cas de chevelure longue, porter un bonnet.



- Fournir aux personnes dont l'expérience est insuffisante des informations adéquates avant toute utilisation de l'appareil.
- L'appareil peut être utilisé par des enfants d'un âge non inférieur à 8 ans et par des personnes ayant des capacités physiques, sensorielles ou mentales réduites, ou sans expérience ou connaissance nécessaire, à condition que ce soit sous surveillance ou après que ces mêmes personnes aient reçu des instructions concernant l'utilisation sûre de l'appareil et concernant la compréhension des dangers inhérents à celui-ci.
- Les enfants ne doivent pas jouer avec l'appareil.
- Le nettoyage et l'entretien destinés à être effectués par l'utilisateur ne doivent pas être effectués par des enfants sans surveillance.
- Utiliser exclusivement le chargeur de batterie dans des lieux fermés et s'assurer que les locaux sont correctement aérés durant l'opération, **NE PAS EXPOSER L'APPAREIL À LA PLUIE OU À LA NEIGE**.
- Débrancher le câble d'alimentation avant de connecter ou de déconnecter les câbles de charge de la batterie.
- Ne pas connecter ou déconnecter les pinces de la batterie quand le chargeur est en fonctionnement.
- N'utiliser sous aucun prétexte le chargeur de batterie à l'intérieur du véhicule ou dans le coffre.
- Remplacer exclusivement le câble d'alimentation par un câble original.
- Si le câble d'alimentation est endommagé, il doit être substitué par le constructeur ou par son service d'assistance technique ou, quoi qu'il en soit, par une personne ayant une qualification similaire, de façon à prévenir tout risque.
- Ne pas utiliser le chargeur de batterie pour recharger des batteries non rechargeables.
- Vérifier que la tension d'alimentation disponible correspond à celle indiquée sur la plaquette signalétique du chargeur de batterie.
- Pour ne pas endommager l'électronique des véhicules, respecter scrupuleusement les avertissements fournis par les constructeurs des véhicules ou des batteries utilisées.
- Ce chargeur de batterie comporte des parties, comme interrupteurs ou relais, risquant de provoquer des arcs électriques ou des étincelles par conséquent, en cas d'utilisation dans un garage ou un lieu du même type, placer le chargeur de batterie dans un local ou une protection adéquats.
- Les interventions de réparation ou d'entretien à l'intérieur du chargeur de batterie doivent exclusivement être effectuées par un

personnel qualifié.

- **ATTENTION: TOUJOURS DÉBRANCHER LE CÂBLE D'ALIMENTATION AVANT TOUTE INTERVENTION D'ENTRETIEN DU CHARGEUR DE BATTERIE, DANGER!**
- Le chargeur de batteries est protégé contre des contacts indirects grâce à un conducteur de terre selon les prescriptions pour les appareils de classe I. Contrôler que la prise est équipée d'une protection de mise à la terre.
- Sur les modèles qui en sont dépourvus, brancher des fiches de portée appropriée, non inférieure, à la valeur du fusible indiquée sur la plaquette de données.



- Appareil de classe A :

Ce chargeur de batteries satisfait les conditions essentielles conformes au standard technique de produit pour l'utilisation en milieu industriel et à but professionnel. La conformité à la compatibilité électromagnétique n'est pas assurée pour les bâtiments domestiques et ceux qui sont directement branchés à un réseau d'alimentation à basse tension qui alimente les bâtiments pour l'usage domestique.

2. DESCRIPTION GÉNÉRALE

Chargeur de batterie indiqué pour la charge de batteries au plomb WET, EFB, GEL, AGM + (Ca) et de batteries au lithium Li utilisés sur des véhicules à moteur (essence et diesel) et sur des véhicules électriques : automobiles, véhicules motorisés, motocycles, embarcations, etc. Il est possible de recharger des batteries de 12V, 24V; on a aussi prévu la modalité démarrage (seulement pour les véhicules avec moteur à essence ou diesel).

Accumulateurs rechargeables en fonction de la tension de sortie disponible : 12V / 6 cellules ; 24V / 12 cellules.

3. INSTALLATION

AGENCEMENT

- Débaler le chargeur de batteries, exécuter le montage des pièces détachées contenues dans l'emballage.
- Les modèles avec chariot doivent être installés en position verticale.

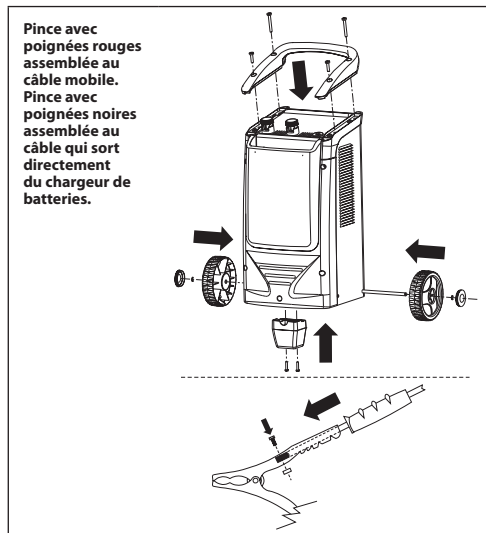

Pince avec poignées rouges assemblée au câble mobile. Pince avec poignées noires assemblée au câble qui sort directement du chargeur de batteries.

3.1 POSITIONNEMENT DU CHARGEUR DE BATTERIES

Durant le fonctionnement, positionner le chargeur de batteries et s'assurer de ne pas entraver le passage d'air à travers les ouvertures prévues à cet effet de façon à garantir une ventilation suffisante.

3.2 BRANCHEMENT AU RÉSEAU ÉLECTRIQUE

- Le chargeur de batteries doit être branché exclusivement à un système d'alimentation avec un conducteur de neutre branché à la terre.
- Contrôler que la tension du réseau électrique correspond à la tension de fonctionnement du chargeur de batteries, reportée sur la plaquette de données.
- La ligne d'alimentation devra être équipée de systèmes de protection, comme des fusibles ou des interrupteurs automatiques, suffisants pour supporter l'absorption maximale de l'appareil.

- Le branchement au réseau électrique doit être effectué avec un câble d'alimentation approprié.
- Les éventuelles rallonges du câble d'alimentation doivent avoir une section adéquate et quoi qu'il en soit, jamais inférieure à celle du câble d'alimentation de l'appareil.
- Il est toujours obligatoire de brancher l'appareil à la terre, en utilisant le conducteur de couleur jaune-vert du câble d'alimentation, portant l'étiquette (⏚), tandis que les deux autres conducteurs seront branchés à la phase et au neutre du réseau électrique de distribution.

4. FONCTIONNEMENT EN CHARGE

NB : Avant de procéder à la charge, vérifier que la capacité des batteries (Ah) que l'on entend soumettre à la charge n'est pas inférieure à celle indiquée sur la plaquette de données du chargeur de batteries (Cmin). Exécuter les instructions en suivant scrupuleusement l'ordre reporté ci-dessous.

4.1 PRÉPARATION DE LA BATTERIE

Si la batterie à charger est de type WET, procéder ainsi :

- Enlever les bouchons de la batterie (s'ils sont présents), de façon à ce que les gaz qui se produisent durant la charge puissent sortir. Contrôler que le niveau de l'électrolyte recouvre les plaques des batteries ; si celles-ci sont découvertes, ajouter de l'eau distillée jusqu'à ce qu'elles soient submergées de 5 ÷ 10 mm.



ATTENTION ! FAIRE TRÈS ATTENTION DURANT CETTE OPÉRATION CAR L'ÉLECTROLYTE EST UN ACIDE HAUTEMENT CORROSIF.

4.2 BRANCHEMENT DU CHARGEUR DE BATTERIES / BATTERIE

- Vérifier que le câble d'alimentation est débranché de la prise de réseau.
- Pour les modèles avec plusieurs tensions de charge, placer le déviateur ou le commutateur en face de la tension de charge choisie au préalable. En l'absence de déviateur ou de commutateur, brancher opportunément le câble avec pince de charge rouge (symbole +) à la borne prévue à cet effet sur le chargeur de batteries en face de la tension de charge choisie au préalable.
- Brancher la pince de charge de couleur rouge à la borne positive de la batterie (symbole +). Si les symboles ne se distinguent pas, nous rappelons que la borne positive est celle non branchée au châssis de la voiture.
- Brancher la pince de charge de couleur noire au châssis de la voiture, loin de la batterie et du conduit du carburant.

NOTE : si la batterie n'est pas installée sur la voiture, se brancher directement à la borne négative de la batterie (symbole -).

4.3 CHARGE SIMULTANÉE DE PLUSIEURS BATTERIES

ATTENTION : ne pas charger de batteries de capacité, déchargement et typologie différentes. Si on doit charger plusieurs batteries en même temps, on peut recourir à des branchements en « série » ou en « parallèle » :

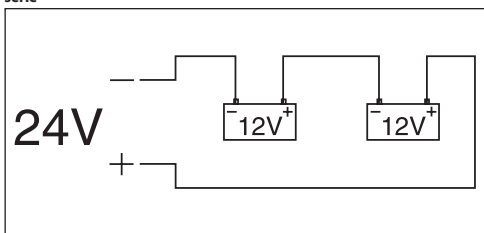

parallèle

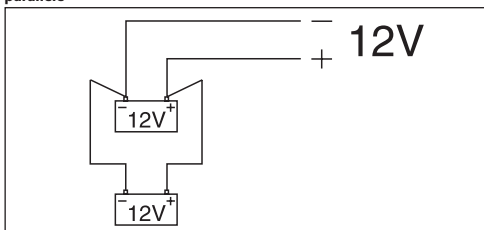

Le branchement en « parallèle » demande que les batteries aient la même tension nominale (Volt), correspondant à celle en sortie du chargeur de batteries et que la somme des Ah soit comprise dans la fourchette de chargement du chargeur de batteries.

Le branchement en « série » demande que les batteries aient la même capacité (Ah) et que la somme des tensions nominales de toutes les batteries corresponde à celle en sortie du chargeur de batteries.

4.4 FIN DE CHARGE

- Enlever ensuite l'alimentation au chargeur de batteries en débranchant la fiche du câble d'alimentation de la prise de réseau.
- Débrancher la pince de charge de couleur noire du châssis de la machine ou de la borne négative de la batterie (symbole -).
- Débrancher la pince de charge de couleur rouge de la borne positive de la batterie (symbole +).
- Remettre le chargeur de batteries dans un lieu sec.
- Refermer les capteurs de la batterie avec les bouchons prévus (s'ils existent).

5. FONCTIONNEMENT EN SYNERGIE

ATTENTION : avant de continuer, observer attentivement les avertissements des constructeurs des véhicules !

- S'assurer de protéger la ligne d'alimentation avec fusibles ou interrupteurs automatiques de la valeur correspondante indiquée sur la plaquette de données avec le symbole (⚡).
- Pour faciliter le démarrage, exécuter une charge rapide préalable de 10-15 minutes, avec chargeur de batteries en position de charge et NON de démarrage.
- Si le démarrage n'a pas lieu, attendre quelques minutes et répéter l'opération de charge rapide. Ne pas insister si le moteur du véhicule ne démarre pas : on pourrait en effet compromettre sérieusement la batterie ou même l'équipement électrique de la voiture.

5.1 BRANCHEMENT DU CHARGEUR DE BATTERIES / BATTERIE

- S'assurer avant de procéder au démarrage du véhicule que la valeur de tension nominale de la batterie correspond à la valeur programmée dans le chargeur de batteries.
- S'assurer que la batterie est bien branchée aux bornes respectives (+ et -), que les branchements vers la batterie sont corrects et que la batterie est en bon état (non sulfatée et non en avarie).
- Il ne faut absolument pas exécuter de démarrages de véhicules avec les batteries débranchées de leurs bornes respectives ; la présence de la batterie est déterminante pour l'élimination d'éventuelles surtensions à cause de l'énergie qui pourrait s'accumuler dans les câbles de branchement durant les phases de démarrage. **Le non-respect de ces dispositions peut endommager l'électronique du véhicule.**

5.2 DÉMARRAGE

- Pour la sélection de cette fonction, voir l'illustration « DÉMARRAGE ».

5.3 FIN DE DÉMARRAGE

- Enlever la fiche du câble d'alimentation de la prise du réseau d'alimentation.
- Débrancher la pince de charge de couleur noire de la borne négative de la batterie (symbole -) et la rouge de la borne positive de la batterie (symbole +).
- Déposer le chargeur de batteries dans un endroit sec.

6. PROTECTIONS DU CHARGEUR DE BATTERIES

Le chargeur de batteries se protège automatiquement en cas de :

- Surcharge (débit de courant excessif vers la batterie).
- Court-circuit (pinces de chargement mises en contact entre elles).
- Inversion de polarités sur les bornes de la batterie.

Sur les appareils munis de fusibles, il est obligatoire en cas de substitution, d'utiliser des pièces de rechange analogues ayant la même valeur de courant nominal.



ATTENTION : Substituer le fusible ayant des valeurs de courant différentes de celles indiquées sur la plaquette pourrait provoquer des dommages aux personnes ou aux choses. Pour la même raison, éviter de la façon la plus absolue, la substitution du fusible par des ponts en cuivre ou autre matériau. L'opération de substitution du fusible doit toujours être exécutée avec le câble d'alimentation DÉBRANCHÉ du réseau. Faire attention durant la substitution du fusible à ruban, quand il est présent, et serrer solidement les écrous de fixation.

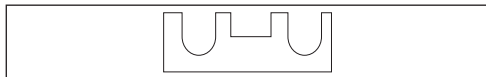

7. CONSEILS UTILES

- Nettoyer les bornes positive et négative de possibles incrustations d'oxyde de façon à assurer un bon contact des pinces.
- Si la batterie avec laquelle on entend utiliser ce chargeur est insérée de façon permanente sur un véhicule, consulter aussi le manuel d'instructions et / ou d'entretien du véhicule à la rubrique « INSTALLATION ÉLECTRIQUE » ou « ENTRETIEN ».



ATENCIÓN: ANTES DE UTILIZAR EL CARGADOR DE BATERÍAS LEER ATENTAMENTE EL MANUAL DE INSTRUCCIONES.

1. SEGURIDAD GENERAL PARA EL USO



- Evitar el contacto con el ácido de la batería. En caso de ser golpeado por una salpicadura o de entrar en contacto con el ácido, enjuagar inmediatamente la parte interesada con agua limpia. Seguir enjuagando hasta la llegada del médico.



- Durante la carga, las baterías emanan gases explosivos, evitar que se formen llamas o chispas. **NO FUMAR.**
- Colocar las baterías en carga en un lugar aireado.



- Proteger los ojos. Siempre utilizar las gafas de protección cuando se trabaja con acumuladores de plomo ácido.



- Vestirse adecuadamente. No ponerse ropa ancha o joyas que puedan engancharse en las partes móviles. Durante los trabajos se recomienda el uso de indumentaria de protección aislada eléctricamente, y además de calzado antiesbalones. En caso de cabello largo, ponerse los gorros de contención.



- Las personas sin experiencia deben recibir la formación adecuada antes de utilizar el aparato.
- El aparato puede ser utilizado por niños de más de 8 años y por personas con capacidades físicas, sensoriales o mentales reducidas, sin experiencia o sin los conocimientos necesarios siempre que estén bajo vigilancia o que hayan recibido instrucciones sobre un uso seguro del aparato y comprendan los peligros inherentes al mismo.
- Los niños no deben jugar con el aparato.
- La limpieza y el mantenimiento destinados a ser realizados por el usuario no deben ser llevados a cabo por niños sin vigilancia.
- Utilizar el cargador de baterías exclusivamente en interiores y asegurarse de trabajar en lugares bien aireados: **NO EXPONER A LLUVIA O NIEVE.**
- Desenluchar el cable de alimentación de la red antes de conectar o desconectar los cables de carga de la batería.
- No conectar o desconectar las pinzas a la batería cuando el cargador esté en funcionamiento.
- No utilizar el cargador de baterías por ningún motivo en el interior de un coche o en el capó.
- Sustituir el cable de alimentación sólo con un cable original.
- Si se ha dañado el cable de alimentación, debe ser sustituido por el fabricante o por su servicio de asistencia técnica o en cualquier caso por una persona con una cualificación similar, para evitar cualquier riesgo.
- No utilizar al cargador de baterías para recargar baterías no recargables.
- Controlar que la tensión de alimentación disponible corresponda con la indicada en la placa de datos del cargador de baterías.
- Para no dañar los componentes electrónicos de los vehículos, observar escrupulosamente las advertencias indicadas por los constructores de los vehículos o de las baterías utilizadas.
- Este cargador de baterías tiene interruptores o relés que pueden provocar arcos o chispas; por lo tanto, si se usa en un garaje o en ambiente similar, deberemos colocarlo en un local o en una parte protegida adecuados para ello.
- Las intervenciones de reparación o mantenimiento en el interior del cargador de baterías deben ser efectuadas sólo por profesionales.
- **ATENCIÓN: ¡QUITAR SIEMPRE EL CABLE DE ALIMENTACIÓN DE**

LA RED ANTES DE EFECTUAR CUALQUIER INTERVENCIÓN DE MANTENIMIENTO SENCILLO DEL CARGADOR DE BATERÍAS, PELIGRO!

- El cargador de baterías se protege contra los contactos indirectos a través de un conductor de tierra, como prescrito para los aparatos de clase I. Controlar que la toma esté provista de conexión de tierra de protección.
- En los modelos que no se han equipado con los mismos, conectar enchufes de capacidad adecuada, no inferior al valor del fusible indicado en la placa de datos.



- Aparato de clase A:

Este cargador de baterías cumple los requisitos de la norma técnica del producto para el uso en ambiente industrial para fines profesionales. No se asegura el cumplimiento de la compatibilidad electromagnética en los edificios domésticos y en los que se conectan directamente a una red de alimentación de baja tensión que alimenta los edificios para el uso doméstico.

2. DESCRIPCIÓN GENERAL

Cargador de baterías indicado para la carga de baterías al plomo WET, EFB, GEL, AGM + (Ca) y baterías al litio Li utilizadas en vehículos a motor (gasolina y diesel) y vehículos eléctricos: automóviles, vehículos a motor, motos, embarcaciones, etc. Se pueden recargar baterías de 12V, 24V; se ha previsto también la modalidad de arranque (solo para los vehículos con motores de gasolina y diesel).

Acumuladores recargables en función de la tensión de salida disponible: 12V / 6 celdas; 24V / 12 celdas.

3. INSTALACIÓN

PREPARACIÓN

- Desembalar el cargador de baterías, efectuar el montaje de las partes separadas que contiene el embalaje.
- Los modelos con carro se deben instalar en posición vertical.

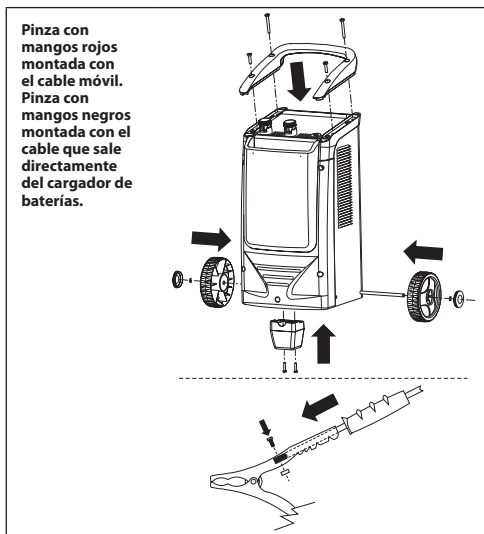

Pinza con mangos rojos montada con el cable móvil. Pinza con mangos negros montada con el cable que sale directamente del cargador de baterías.

3.1 UBICACIÓN DEL CARGADOR DE BATERÍAS

Durante el funcionamiento posicionar de forma estable el cargador de baterías y comprobar que no se obstruya el paso de aire a través de las aberturas correspondientes, garantizando de esta forma una ventilación suficiente.

3.2 CONEXIÓN A LA RED ELÉCTRICA

- El cargador de baterías tiene que conectarse exclusivamente a un sistema de alimentación con un conductor de neutro conectado a tierra.
- Controlar que la tensión de la red eléctrica corresponda a la tensión eléctrica de funcionamiento del cargador de batería indicada en la placa de datos.
- La línea de alimentación tendrá que equiparse con sistemas de protección, como fusibles o interruptores automáticos, suficientes

para soportar la absorción máxima del equipo.

- La conexión a la red eléctrica tiene que realizarse con un cable específico de alimentación.
- Las posibles extensiones del cable de alimentación tienen que tener una sección adecuada y, de cualquier forma, nunca inferior a la del cable de alimentación del aparato.
- Siempre es obligatorio conectar a tierra el aparato, utilizando el conductor de color amarillo-verde del cable de alimentación, marcado por la etiqueta (↓), mientras que los otros dos conductores tendrán que conectarse a la fase y al neutro de la red eléctrica de distribución.

4. FUNCIONAMIENTO EN CARGA

CUIDADO: Antes de proceder a la carga, comprobar que la capacidad de la batería (Ah) que se desea someter a carga no sea inferior con respecto a la que se indica en la placa de datos del cargador de baterías (Cmín). Observar las instrucciones siguiendo escrupulosamente el orden que se indica a continuación.

4.1 PREPARACIÓN DE LA BATERÍA

Si la batería que hay que recargar es de tipo WET, proceder como se indica a continuación:

- Quitar las tapas de la batería (si están presentes), de forma que los gases que se producen durante la carga puedan salir. Controlar que el nivel del electrolito cubra las placas de la batería; si éstas resultaran descubiertas añadir agua destilada hasta sumergirlas de 5 - 10 mm.



¡ATENCIÓN! PRESTAR LA MÁXIMA CAUTELA DURANTE ESTA OPERACIÓN, YA QUE EL ELECTROLITO ES UN ÁCIDO ALTAMENTE CORROSIVO.

4.2 CONEXIÓN CARGADOR DE BATERÍAS/BATERÍA

- Comprobar que el cable de alimentación esté desconectado de la toma de red.
- Para los modelos con varias tensiones de carga, colocar el desviador o el conmutador en correspondencia de la tensión de carga elegida. Si no hay desviador o conmutador, conectar adecuadamente el cable con la pinza de carga roja (símbolo +) al borne específico del cargador de baterías en correspondencia de la tensión de carga elegida.
- Conectar la pinza de carga de color rojo al borne positivo de la batería (símbolo +). Si los símbolos no se distinguen se recuerda que el borne positivo es el que no se ha conectado al bastidor del vehículo.
- Conectar la pinza de carga de color negro al bastidor de la máquina, lejos de la batería y del conducto del combustible.
NOTA: Si la batería no se ha instalado en la máquina, conectarse directamente al borne negativo de la batería (símbolo -).

4.3 CARGA SIMULTÁNEA DE VARIAS BATERÍAS

ATENCIÓN: no cargar baterías de capacidad, descarga y tipos distintos entre ellas. Si hay que cargar varias baterías contemporáneamente, es posible utilizar unas conexiones en "serie" o en "paralelo".

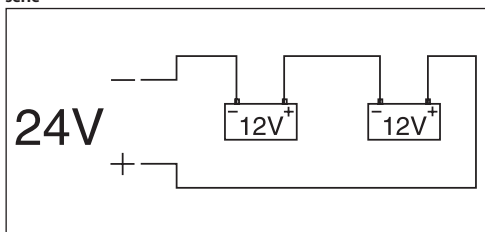

paralelo

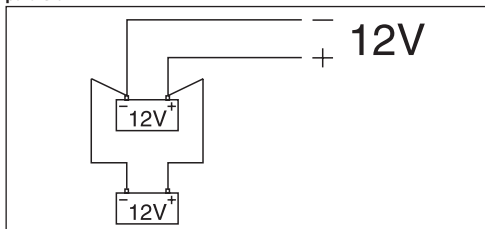

La conexión en "paralelo" requiere que las baterías tengan la misma tensión nominal (Volts) que corresponde a la tensión en salida desde el cargador de baterías y que la suma de los Ah se encuentre incluida en el rango de carga del cargador de baterías.

La conexión en "serie" requiere que las baterías tengan la misma

capacidad (Ah) y que la suma de las tensiones eléctricas nominales de todas las baterías corresponda a la tensión en la salida del cargador de baterías.

4.4. TERMINACIÓN DE LA CARGA

- Quitar la alimentación al cargador de baterías sacando el enchufe del cable de alimentación desde la toma de corriente de red eléctrica.
- Desconectar la pinza de carga de color negro desde el bastidor del vehículo o desde el borne negativo de la batería (símbolo -).
- Desconectar la pinza de carga de color rojo desde el borne positivo de la batería (símbolo +).
- Guardar el cargador de las baterías en un lugar seco.
- Volver a cerrar las celdas de la batería con los tapones correspondientes (si están presentes).

5. FUNCIONAMIENTO EN ARRANQUE

ATENCIÓN: Antes de seguir adelante observar atentamente las advertencias de los fabricantes de los vehículos.

- Asegurarse de proteger la línea de alimentación con fusibles o interruptores automáticos con un valor que corresponda al indicado en la placa de datos con el símbolo (≡).
- Para facilitar el arranque, efectuar previamente una carga rápida de 10-15 minutos, con cargador de baterías en posición de carga y NO de arranque.
- Si el vehículo no arranca, esperar unos minutos y repetir la operación de carga rápida. No insistir más si el motor del vehículo no arranca; podría ponerse seriamente en peligro la batería o incluso el equipo eléctrico del vehículo.

5.1 CONEXIÓN CARGADOR DE BATERÍAS/BATERÍA

- Antes de seguir adelante con el arranque del vehículo asegurarse de que el valor de tensión nominal de la batería corresponde con el valor configurado en el cargador de baterías.
- Asegurarse de que la batería esté bien conectada a los respectivos bornes (+ y -) que las conexiones a la batería sean correctas y que la batería esté en buen estado (no sulfatada y no averiada).
- No efectuar por ningún motivo arranques de vehículos con baterías desconectadas de los respectivos bornes; la presencia de la batería es determinante para eliminar posibles subidas de tensión por efecto de la energía que se podría acumular en los cables de conexión durante las fases de arranque. **La falta de respeto de estas disposiciones puede dañar la electrónica del vehículo.**

5.2 ARRANQUE

- Para seleccionar esta función, véase la ilustración "ARRANQUE".

5.3 FINAL DE ARRANQUE

- Sacar el enchufe del cable de alimentación de la toma de corriente de la red de alimentación.
- Desconectar la pinza de carga de color negro del borne negativo de la batería (símbolo -) y la roja del borne positivo de la batería (símbolo +).
- Guardar el cargador de baterías en un lugar seco.

6. PROTECCIONES DEL CARGADOR DE BATERÍAS

El cargador de baterías se autoprotege en caso de:

- Sobrecarga (distribución excesiva de corriente hacia la batería).
- Cortocircuito (pinzas de carga que han entrado en contacto entre ellas).
- Inversión de polaridad en los bornes de la batería.

En aparatos provistos de fusibles, es obligatorio en caso de sustitución usar recambios análogos que tengan el mismo valor de corriente nominal.



ATENCIÓN: Sustituir el fusible con valores de corriente diferentes de los indicados en la placa podría provocar daños a personas o cosas. Por el mismo motivo, evitar tajantemente la sustitución del fusible con puentes de cobre u otro material. La operación de sustitución del fusible siempre debe efectuarse con el cable del alimentación SACADO de la red. Prestar atención durante la sustitución del fusible plano, si está presente, y ajustar firmemente las tuercas de fijación.

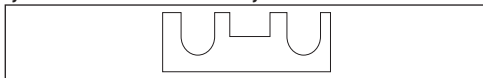

7. CONSEJOS ÚTILES

- Limpiar los bornes positivo y negativo de posibles incrustaciones de óxido de manera que se asegure un buen contacto de las pinzas.
- Si la batería en la que se desea utilizar este cargador de baterías está introducida de manera permanente en el vehículo, consultar también el manual de instrucciones y/o de mantenimiento del vehículo en la opción "INSTALACIÓN ELÉCTRICA" o "MANTENIMIENTO".



ACHTUNG: VOR DER BENUTZUNG DES LADEGERÄTES LESEN SIE BITTE AUFMERKSAM DIE BETRIEBSANLEITUNG!

1. ALLGEMEINE SICHERHEITSVORSCHRIFTEN FÜR DEN GEBRAUCH



- Vermeiden Sie den Kontakt mit der Batteriesäure. Falls Sie Spritzer abbekommen oder mit der Säure in Berührung kommen, spülen Sie den betroffenen Bereich sofort mit sauberem Wasser ab. Fahren Sie damit fort, bis der Arzt eintrifft.



- Während des Ladens entweichen aus der Batterie Explosivgase, vermeiden Sie daher offene Flammen oder Funkenflug. **NICHT RAUCHEN.**
- Stellen Sie die Batterien während des Ladevorganges an einen gut belüfteten Ort.



- Schützen Sie die Augen. Tragen Sie beim Umgang mit Blei-Säure-Batterien stets eine Schutzbrille.



- Kleiden Sie sich sachgerecht. Tragen Sie keine weite Kleidung oder Schmuckstücke, die sich in Bewegungsteilen verfangen können. Es wird empfohlen, während der Arbeiten elektrisch isolierte Schutzkleidung sowie rutschfestes Schuhwerk zu tragen. Langes Haar sollte mit einer Kopfbedeckung gebündelt werden.



- Unerfahrene Personen müssen vor dem Gebrauch des Gerätes in angemessener Weise unterwiesen werden.
- Das Gerät darf von Kindern ab 8 Jahren und von Personen mit eingeschränkter körperlicher, sensorischer oder mentaler Fähigkeiten bzw. ohne Erfahrung oder der notwendigen Kenntnis verwendet werden, wenn vorausgesetzt ist, dass dies unter Aufsicht erfolgt oder nachdem sie entsprechende Anweisungen für den sicheren Gebrauch des Gerätes erhalten und die Gefahren, die mit ihm einhergehen, verstanden haben.
- Kindern ist das Spielen mit dem Gerät untersagt.
- Die Reinigung und die Wartung, die dem Anwender obliegen, dürfen von Kindern nur unter Aufsicht durchgeführt werden.
- Verwenden Sie das Gerät nur in geschlossenen Räumen und sorgen Sie für gut gelüftete Arbeitsplätze. **NICHT DEM REGEN ODER SCHNEE AUSSETZEN.**
- Ziehen Sie das Netzkabel aus der Steckdose, bevor Sie die Ladungskabel der Batterie anschließen oder ausstecken.
- Nicht die Zangen an die Batterie einstecken oder ausstecken bei funktionierendem Ladegerät.
- Auf keinen Fall soll das Gerät im Inneren des Autos oder der Motorhaube benutzt werden.
- Ersetzen Sie das Netzkabel nur durch ein Originalkabel.
- Sollte das Versorgungskabel beschädigt sein, muss dieses durch den Hersteller oder den technischen Kundendienst bzw. durch eine hierfür qualifizierte Person ausgetauscht werden, um jedem Risiko entgegenzuwirken.
- Verwenden Sie das Ladegerät nicht für die Ladung von Batterien, die nicht nachgeladen werden können.
- Prüfen Sie, ob die verfügbare Versorgungsspannung der Angabe auf dem Datenschild des Ladegerätes entspricht.
- Damit die Fahrzeugelektronik keinen Schaden nimmt, sind die Hinweise des Fahrzeugherstellers oder des Batterieherstellers genau zu befolgen.
- Dieses Ladegerät enthält Teile wie z. B. einen Abschalter oder ein Relais, die Funken oder Lichtbögen erzeugen können. Deswegen sollte das Gerät, wenn es in einer Garage oder an einem ähnlichen Ort verwendet wird, an einer geschützten Stelle unter Aufsicht in Betrieb genommen werden.

- Reparatur- oder Instandhaltungsarbeiten im Inneren des Gerätes dürfen nur von geschultem Personal vorgenommen werden.
- **ACHTUNG! BEVOR SIE DIE GERINGSTE WARTUNGSARBEIT AM GERÄT DURCHFÜHREN, UNBEDINGT DAS GERÄT AUSSTECKEN: GEFAHR!**
- Das Batterieladegerät ist durch einen Erdleiter vor indirekten Kontakten geschützt, wie es für die Geräte der Klasse I vorgeschrieben ist. Kontrollieren Sie, daß die Steckdose eine Verbindung zur Schutzerde hat.
- Bei den Modellen, bei denen dies nicht vorgesehen ist, Stecker mit passender Ladefähigkeit verbinden, d.h. nicht unter dem auf dem Typenschild angegebenen Wert der Schmelzsicherung.



- Gerät der Klasse A:
Dieses Batterieladegerät erfüllt die Vorgaben des technischen Produktstandards bei der gewerblichen und fachmännischen Nutzung. Die Übereinstimmung mit der elektromagnetischen Verträglichkeit in Wohngebäuden und in den Gebäuden, die direkt an ein Niederspannungsnetz angeschlossen sind, welches die Wohngebäude versorgt, ist nicht garantiert.

2. ALLGEMEINE BESCHREIBUNG

Batterieladegerät, geeignet zum Laden von Bleibatterien WET, EFB, GEL, AGM + (Ca) und Lithiumbatterien Li, die bei motorbetriebenen Fahrzeugen (Benzin und Diesel) und Elektrofahrzeugen wie beispielsweise bei Autos, Motorrädern und Booten verwendet werden. 12V- und 24V-Batterien können aufgeladen werden. Zudem ist auch der Startmodus (nur für Fahrzeuge mit Benzin- und Dieselmotor) vorgesehen.

Basierend auf der verfügbaren Ausgangsspannung aufladbare Akkumulatoren: 12V / 6 Zellen; 24V / 12 Zellen.

3. INSTALLATION

HERSTELLEN DES BETRIEBSZUSTANDES

- Das Batterieladegerät auspacken und die in der Verpackung enthaltenen losen Teile zusammenbauen.
- Verfahrbare Modelle sind vertikal zu installieren.

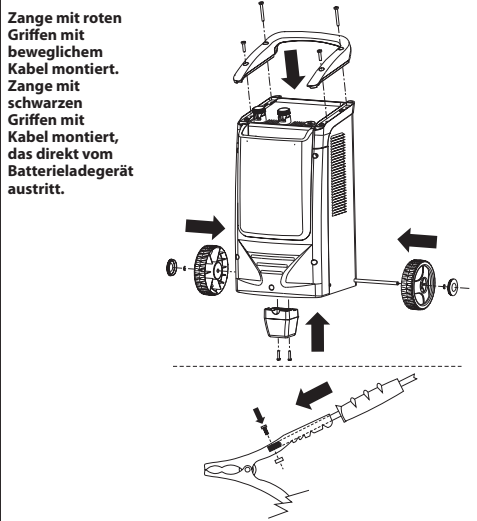

3.1 AUFSTELLUNG DES BATTERIELADEGERÄTES

Während des Betriebes ist das Ladegerät stabil zu positionieren. Dabei muss sichergestellt sein, dass die Luft ungehindert durch die zugehörigen Öffnungen strömen kann, um somit für eine ausreichende Luftzufuhr zu sorgen.

3.2 ANSCHLUSS AN DAS STROMVERSORGUNGSNETZ

- Das Batterieladegerät darf ausschließlich an eine Versorgungsanlage mit Neutralleiter und Erdung angeschlossen werden.
- Kontrollieren Sie, ob die Netzspannung der auf dem Typenschild angegebenen Betriebsspannung des Batterieladegerätes entspricht.
- Die Versorgungsleitung muss mit Schutzsystemen wie Schmelzsicherungen oder Leistungsschaltern ausgestattet sein, die der maximalen Aufnahme des Gerätes standhalten.

- Der Netzanschluss ist mit dem passenden Versorgungskabel vorzunehmen.
- Mögliche Verlängerungen des Versorgungskabels müssen einen sachgerechten Querschnitt haben, der in keinem Fall geringer sein darf als der des Versorgungskabels des Geräts.
- Das Gerät muss immer an die Erdung unter Verwendung des gelbgrünen Leiters des Versorgungskabels angeschlossen werden. Dieser ist mit einem Etikett (↓) gekennzeichnet, wohingegen die beiden anderen Leiter an die Phase und den Neutralleiter des Versorgungsnetzes anzuschließen sind.

4. BETRIEB BEIM LADEN

Anmerkung: Vor dem Laden ist zu prüfen, ob die Batteriekapazität (Ah), auf die geladen werden soll, nicht unter dem auf dem Typenschild des Batterieladegeräts angegebenen Wert liegt (Cmin). Die Anleitung ist - in der nachstehenden Reihenfolge - genau zu befolgen.

4.1 VORBEREITUNG BATTERIE

Wenn es sich bei der aufzuladenden Batterie um den Typ WET handelt, wie folgt vorgehen:

- Vorhandene Stopfen der Batterie entfernen (falls vorhanden), sodass die beim Laden entstehenden Gase entweichen können. Prüfen Sie, ob das Elektrolyt so hoch steht, dass die Batterieplatten bedeckt sind. Liegen diese frei, ist destilliertes Wasser nachzufüllen, bis die Platten von etwa 5 - 10 mm Wasser bedeckt sind.



ACHTUNG! WÄHREND DIESES VORGANGS IST HÖCHSTE VORSICHT GEBOTEN, WEIL DAS ELEKTROLYT EINE STARK ÄTZENDE SÄURE IST.

4.2 ANSCHLUSS BATTERIELADEGERÄT / BATTERIE

- Überprüfen, dass das Versorgungskabel von der Netzdose getrennt ist.
 - Für Modelle mit mehr Ladenspannungen den Wechselschalter oder den Umschalter entsprechend der vorab gewählten Spannung positionieren. Sollten kein Wechsel- oder Umschalter vorhanden sein, folglich das Kabel mit der roten Ladezange (Symbol +) an der spezifischen Klemme des Batterieladegeräts entsprechend der vorab gewählten Ladenspannung verbinden.
 - Die rote Ladezange an die Plusklemme der Batterie (Symbol +) anschließen. Wenn sich die Symbole nicht erkennen lassen, sei daran erinnert, dass die Plusklemme die Klemme ist, die nicht mit dem Fahrgestell des Fahrzeugs verbunden ist.
 - Die schwarze Ladeklemme, fern der Batterie und der Treibstoffleitung, an das Fahrgestell des Fahrzeugs anschließen.
- ANMERKUNG: Wenn die Batterie nicht in das Fahrzeug eingebaut ist, ist die direkte Verbindung zur Minusklemme der Batterie (Symbol -) herzustellen.

4.3 GLEICHZEITIGES LADEN MEHRERER BATTERIEN

ACHTUNG: Keine Batterien aufladen, die sich in ihrer Kapazität, Entladung und Typologie voneinander unterscheiden. Müssen mehrere Batterien gleichzeitig aufgeladen werden, können sie „in Reihe“ oder „parallel“ geschaltet werden:

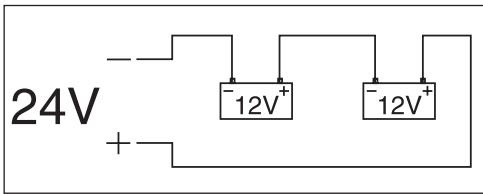

parallel

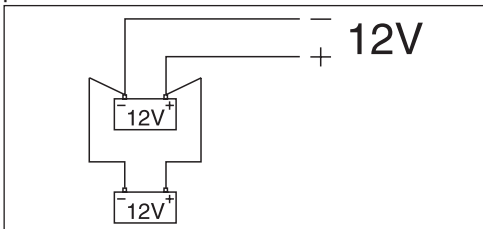

Sollten sie „parallel“ geschaltet werden, so müssen die Batterien dieselbe Nennspannung besitzen (Volt), die der am Ausgang des Batterieladegeräts entspricht und die Summe der Ah muss innerhalb des Ladebereichs des Batterieladegeräts liegen.

Sollten sie „in Reihe“ geschaltet sein, so müssen die Batterien dieselbe

Kapazität (Ah) aufweisen und die Summe der Nennspannungen aller Batterien muss der am Ausgang des Batterieladegeräts entsprechen.

4.4. ENDE LADEVORGANG

- Die Stromversorgung des Batterieladegeräts unterbrechen, indem der Stecker des Versorgungskabels von der Netzdose abgezogen wird.
- Die schwarze Ladezange vom Fahrgestell des Fahrzeugs oder der Minusklemme der Batterie (Symbol -) lösen.
- Die rote Ladezange von der Plusklemme der Batterie (Symbol +) lösen.
- Das Batterieladegerät wieder an einem trockenen Ort ablegen.
- Die Batteriezellen wieder mit den zugehörigen Stopfen schließen (falls vorhanden).

5. BETRIEB BEIM STARTEN

ACHTUNG: Vor Beginn die Warnhinweise der Fahrzeughersteller genau beachten!

- Sicherstellen, dass die Versorgungsleitung mit Schmelzsicherungen oder Automatikschaltern entsprechend dem Wert, der auf dem Typenschild mit dem Symbol (—) angegeben ist, abgesichert ist.
- Für einen einfacheren Startvorgang vorab eine Schnellaufladung von 10-15 Minuten mit dem Batterieladegerät in der Lade- und NICHT in der Startposition durchführen.
- Sollte das Starten des Fahrzeugs nicht möglich sein, einige Minuten lang warten und die Schnellaufladung wiederholen. Sollte der Fahrzeugmotor nicht starten, darf dennoch nicht fortgefahren werden; tatsächlich könnte die Batterie sonst ernsthaft beschädigt oder sogar die elektrische Ausstattung des Fahrzeugs gefährdet werden.

5.1 ANSCHLUSS BATTERIELADEGERÄT / BATTERIE

- Bevor mit dem Fahrzeugstart begonnen wird, sicherstellen, dass der Wert der Nennspannung der Batterie dem am Batterieladegerät eingestellten Wert entspricht.
- Sich vergewissern, dass die Batterie gut mit den zugehörigen Klemmen (+ und -) verbunden ist, die Batterieanschlüsse korrekt ausgeführt sind und sich die Batterie in einem guten Zustand befindet (nicht sulfatiert und nicht beschädigt).
- Auf gar keinen Fall Startvorgänge an Fahrzeugen mit Batterien vornehmen, deren zugehörige Klemmen nicht angeschlossen sind. Das Vorhandensein der Batterie ist bestimmend für die Beseitigung eventueller Überspannungen aufgrund der Energie, die sich in den Anschlusskabeln während des Startvorgangs ansammeln könnte. **Die Nichtbeachtung dieser Angaben kann zu Schäden an der Fahrzeugelektronik führen.**

5.2 STARTVORGANG

- Zum Auswählen dieser Funktion, siehe die Abbildung „STARTEN“.

5.3. ENDE STARTVORGANG

- Den Stecker des Versorgungskabels von der Netzdose abtrennen.
- Die schwarze Ladezange von der Minusklemme der Batterie (Symbol -) und die rote Ladezange von der Plusklemme der Batterie (Symbol +) lösen.
- Das Batterieladegerät wieder an einem trockenen Ort lagern.

6. SCHUTZEINRICHTUNGEN DES LADEGERÄTS

Das Batterieladegerät schützt sich in den folgenden Fällen selbst:

- Überlast (zu starke Stromzufuhr zur Batterie).
- Kurzschluss (Ladezangen berühren sich).
- Vertauschte Polung an den Batterieklammern.

Bei den mit Schmelzsicherungen ausgestatteten Geräten müssen im Falle eines Austauschs gleichartige Ersatzteile verwendet werden, die denselben Nennstromwert haben.



ACHTUNG: Sollte die Schmelzsicherung mit anderen als auf dem Typenschild angegebenen Stromwerten ausgetauscht werden, könnte dies zu Personen- oder Sachschäden führen. Aus demselben Grund sollte absolut vermieden werden, dass die Schmelzsicherung mit Kupferbrücken oder anderen Materialien ausgetauscht wird. Der Austausch der Schmelzsicherung muss immer mit vom Stromnetz GETRENNTEM Versorgungskabel erfolgen. Beim Austausch der Schmelzstreifen-sicherung, dort, wo vorhanden, achtsam agieren und die Befestigungsmuttern gut festziehen.



7. HILFREICHE RATSCHLÄGE

- Reinigen Sie die Plus- und Minusklemme von Oxidablagerungen, um den einwandfreien Kontakt der Zangen sicherzustellen.
- Ist die Batterie, bei der das Batterieladegerät angewendet werden soll, fest in ein Fahrzeug eingebaut, schlagen Sie bitte auch die Punkte „ELEKTROANLAGE“ oder „WARTUNG“ im Betriebs- und Wartungshandbuch des Fahrzeugs nach.



ВНИМАНИЕ: ПЕРЕД ИСПОЛЬЗОВАНИЕМ ЗАРЯДНОГО УСТРОЙСТВА АККУМУЛЯТОРНОЙ БАТАРЕИ ВНИМАТЕЛЬНО ПРОЧИТАЙТЕ РАБОЧЕЕ РУКОВОДСТВО!

1. ОБЩАЯ БЕЗОПАСНОСТЬ ПРИ ИСПОЛЬЗОВАНИИ



- Избегать контакта с кислотой аккумулятора. В случае попадания брызг или контакта с кислотой, необходимо немедленно промыть поврежденную часть чистой водой. Продолжать промывать поврежденную часть до прибытия врача.



- Во время зарядки из аккумуляторной батареи выходит взрывчатый газ, избегать образования пламени и искрения. НЕ КУРИТЬ.
- Установить аккумуляторную батарею во время зарядки в хорошо проветриваемое место.



- Защитить глаза. Необходимо всегда пользоваться защитными очками при работе со свинцовыми-кислотными аккумуляторами.



- Носить подходящую для работы одежду. Не носить широкую одежду или украшения, которые могут попасть в части в движении. Во время выполнения работ рекомендуется использовать защитную одежду с электрической изоляцией, а также носить не скользкую обувь. Если у вас длинные волосы, нужно покрывать голову.



- Неопытный персонал должен пройти соответствующее обучение перед использованием оборудования.
- Аппарат разрешается использовать детям в возрасте от 8 лет и лицам с ограниченными физическими, сенсорными или умственными способностями, или без опыта или необходимых знаний при условии, что они находятся под присмотром либо прошли инструктаж относительно безопасного использования аппарата и понимают связанные с ним риски.
- Детям запрещается играть с аппаратом.
- Детям без присмотра запрещается осуществлять чистку и предусмотренное техобслуживание.
- Использовать зарядное устройство батареи только в помещении и работать в хорошо проветриваемых местах: НЕ ПОДВЕРГАТЬ ДЕЙСТВИЮ ДОЖДЯ И СНЕГА.
- Отсоединить от сети кабель питания перед тем, как соединять и отсоединять зарядный кабель от аккумуляторной батареи.
- Не присоединять и не отсоединять зажимы от батареи при работающем зарядном устройстве батареи.
- Никогда не использовать зарядное устройство батареи внутри салона автомобиля или внутри капота.
- Заменять кабель питания только на оригинальный кабель.
- В случае повреждения кабеля питания, его замену необходимо доверить специалисту изготовителя или сервисного центра, либо другому лицу, обладающему аналогичной квалификацией, чтобы устранить все возможные риски.
- Не использовать зарядное устройство батареи для зарядки аккумуляторных батарей не заряжаемого типа.
- Проверить, что имеющееся напряжение питания соответствует указанному на табличке с характеристиками зарядного устройства батареи.
- Чтобы не повредить электронику транспортных средств, тщательно соблюдайте предупреждения, предоставленные производителем транспортных средств или используемых аккумуляторов.
- Это зарядное устройство батареи включает такие части, как переключатели и реле, могущие спровоцировать дугу и искры; поэтому, если вы используете устройство в гараже и подобном помещении, поместить зарядное устройство аккумуляторной батареи в место, подходящее для его хранения.

- Ремонт и техобслуживание внутренней части зарядного устройства батареи должны выполняться только опытным персоналом.
- **ВНИМАНИЕ: ВСЕГДА ОТСОЕДИНЯТЬ КАБЕЛЬ ПИТАНИЯ ОТ СЕТИ ПЕРЕД ТЕМ, КАК ВЫПОЛНЯТЬ ЛЮБЫЕ ДЕЙСТВИЯ ОБЫЧНОГО ТЕХОБСЛУЖИВАНИЯ ЗАРЯДНОГО УСТРОЙСТВА БАТАРЕИ, ОПАСНОСТИ!**
- Зарядное устройство защищено от косвенных контактов при помощи заземляющего проводника согласно требованиям к аппаратуре класса I. Проверить, что розетка оснащена соединением заземления.
- В моделях, которые не оснащены штепселем, подсоедините штепсель соответствующего номинала, но не ниже значения предохранителя, указанного в табличке технических данных.



Оборудование класса A:

Это зарядное устройство соответствует требованиям технических стандартов изделий, предназначенных для использования в промышленной среде и в профессиональных целях. Не гарантируется электромагнитная совместимость в жилых зданиях, а также в строениях, напрямую подсоединенных к линии питания низкого напряжения, предназначенной для жилых зданий.

2. ОБЩЕЕ ОПИСАНИЕ

Это зарядное устройство предназначено для зарядки свинцовых аккумуляторов типа WET, EFB, GEL, AGM + (Ca) и литиевых аккумуляторов Li, используемых в моторизованных транспортных средствах (с бензиновым и дизельным двигателем) и электрических транспортных средствах: автомобилях, автомобилях, мотоциклах, лодках и др. Допускается зарядка аккумуляторов напряжением 12 В и 24 В; предусмотрен также режим помощи при запуске (только для транспортных средств с бензиновым и дизельным двигателем).

Возможна зарядка аккумуляторов со следующим выходным напряжением: 12 В / 6 элементов; 24 В / 12 элементов.

3. УСТАНОВКА ПОДГОТОВКА

- Распакуйте зарядное устройство, соберите отдельные части, содержащиеся в упаковке.
- Передвижные модели необходимо установить в вертикальном положении.

Зажим с красной ручкой, к которой прикреплен свободный кабель, зажим с черной ручкой, к которой прикреплен кабель, выходящий непосредственно из зарядного устройства.

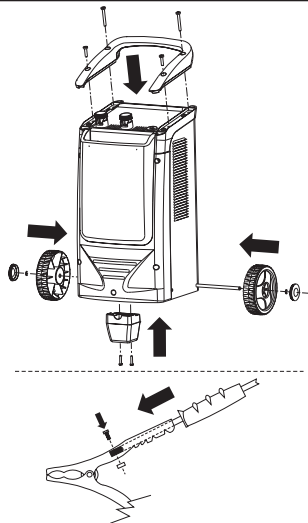

3.1 РАСПОЛОЖЕНИЕ ЗАРЯДНОГО УСТРОЙСТВА

Во время использования установите зарядное устройство в устойчивое положение и убедитесь, что не нарушит поток воздуха через соответствующие отверстия, обеспечив тем самым правильную вентиляцию.

3.2 ПОДКЛЮЧЕНИЕ К ЭЛЕКТРОСЕТИ

- Зарядное устройство разрешается подключать только к системе питания с заземленным нейтральным проводом.
- Убедитесь, что напряжение электросети соответствует рабочему напряжению зарядного устройства, указанному в табличке технических данных.
- Линия питания должна быть оснащена защитными системами, такими как предохранители или автоматические выключатели, способными

- выдержать максимальный ток, потребляемый оборудованием.
- Для подключения к электросети необходимо использовать специальный кабель питания.
- В случае использования удлинителей, поперечное сечение проводников должно быть соответствующим и ни в коем случае оно не должно быть меньше поперечного сечения кабеля питания устройства.
- Устройство обязательно должно быть заземлено, используя проводник кабеля питания желто-зеленого цвета, обозначенный этикеткой (↓), при этом остальные два проводника соединяются с фазой и нейтралью электросети.

4. ФУНКЦИОНИРОВАНИЕ В РЕЖИМЕ ЗАРЯДКИ

Примечание: Перед тем как начать зарядку, убедитесь, что емкость аккумулятора (А-ч), который предполагается зарядить, не ниже значения, указанного на табличке технических данных зарядного устройства (Spn). Следуйте указаниям, строго соблюдая указанный порядок.

4.1 ПОДГОТОВКА АККУМУЛЯТОРА

Если предполагается зарядить аккумулятор типа WET, действуйте следующим образом:

- Снимите крышки аккумулятора (если они имеются), чтобы газы, образующиеся во время зарядки, могли выйти наружу. Убедитесь, что электродит покрывает пластины аккумулятора; если они не покрыты, добавьте дистиллированную воду, чтобы погрузить пластины на глубину 5–10 мм.



ВНИМАНИЕ! ВО ВРЕМЯ ЭТОЙ ОПЕРАЦИИ СОБЛЮДАЙТЕ ОСОБУЮ ОСТОРОЖНОСТЬ, ПОСКОЛЬКУ ЭЛЕКТРОЛИТ ЯВЛЯЕТСЯ ОЧЕНЬ ЕДКОЙ КИСЛОТОЙ.

4.2 СОЕДИНЕНИЕ ЗАРЯДНОГО УСТРОЙСТВА/АККУМУЛЯТОРА

- Убедитесь, что кабель питания отсоединен от розетки электросети.
- В моделях, поддерживающих несколько уровней напряжения, установите девиатор или переключатель согласно необходимому напряжению зарядки. В случае отсутствия девиатора или переключателя, прикрепите кабель с красным зажимом (символ +) к клемме зарядного устройства, соответствующей напряжению зарядки.
- Подсоедините красный зарядный зажим к положительной клемме аккумулятора (символ +). Если символы не удается различить, напоминаем, что положительная клемма – это клемма, которая не подключена к шасси автомобиля.
- Подсоедините зарядный зажим черного цвета к шасси автомобиля, вдали от аккумулятора и топливопровода.
ПРИМЕЧАНИЕ: Если аккумулятор не установлен в автомобиль, подсоедините его непосредственно к отрицательной клемме аккумулятора (символ -).

4.3 ОДНОВРЕМЕННАЯ ЗАРЯДКА НЕСКОЛЬКИХ АККУМУЛЯТОРОВ

ВНИМАНИЕ: не осуществлять зарядку аккумуляторов с различной емкостью, степенью разрядки и различного типа. В случае если необходимо одновременно зарядить несколько аккумуляторов, их можно соединить "последовательно" или "параллельно":
последовательно

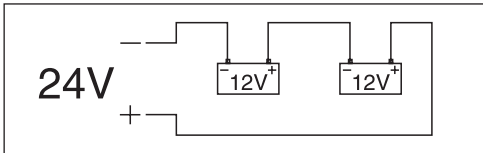

параллельно

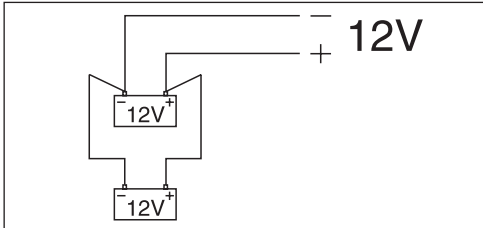

Для "параллельного" соединения аккумуляторов необходимо, чтобы у них было одинаковое номинальное напряжение (выраженное в вольтах), соответствующее выходному напряжению зарядного устройства и, чтобы сумма емкостей, выраженная в ампер-часах (А-ч), была в допустимом диапазоне зарядного устройства.

Для "последовательного" соединения аккумуляторов необходимо, чтобы у них была одинаковая емкость (выраженная в ампер-часах, А-ч) и, чтобы сумма

номинальных напряжений всех аккумуляторов соответствовала выходному напряжению зарядного устройства.

4.4 ЗАВЕРШЕНИЕ ЗАРЯДКИ

- Отключите питание зарядного устройства, отсоединив штепсель кабеля питания от розетки электросети.
- Отсоедините зарядный зажим черного цвета от шасси транспортного средства или от отрицательной клеммы аккумулятора (символ -).
- Отсоедините красный зарядный зажим от положительной клеммы аккумулятора (символ +).
- Поставьте зарядное устройство в сухое место.
- Закройте элементы аккумулятора соответствующими крышками (если они имеются).

5. ФУНКЦИОНИРОВАНИЕ В РЕЖИМЕ ЗАПУСКА

ВНИМАНИЕ: перед тем как продолжить, внимательно ознакомьтесь с предупреждениями изготовителя транспортного средства!

- Убедитесь, что линия питания защищена предохранителями или автоматическими выключателями с номиналом, соответствующим значению, обозначенному в табличке технических данных символом ().
- Для упрощения запуска, выполните быструю предварительную зарядку в течение 10-15 минут, установив зарядное устройство в положение зарядки, а НЕ пуска.
- Если транспортное средство не удается запустить, подождите несколько минут и повторите операцию быстрой зарядки. Не продолжайте попытки, если двигатель транспортного средства не удается запустить; можно серьезно повредить аккумулятор или электрооборудование транспортного средства.

5.1 СОЕДИНЕНИЕ ЗАРЯДНОГО УСТРОЙСТВА/АККУМУЛЯТОРА

- Перед тем как приступить к запуску транспортного средства, убедитесь, что значение номинального напряжения аккумулятора соответствует значению, установленному в зарядном устройстве.
- Убедитесь, что аккумулятор хорошо подсоединен к соответствующим клеммам (+ и -), что соединение с аккумулятором выполнено правильно и, что аккумулятор находится в хорошем состоянии (не подвержен сульфатации и не поврежден).
- Категорически запрещается осуществлять запуск транспортных средств, пока аккумулятор отсоединен от соответствующих клемм. Наличие аккумулятора является очень важным для предотвращения возможного перенапряжения из-за энергии, которая может скопиться в соединительных кабелях во время пуска. **Несоблюдение этих указаний может привести к повреждению электроники транспортного средства.**

5.2 ЗАПУСК

- Для того, чтобы выбрать эту функцию, см. иллюстрацию "ЗАПУСК".

5.3 ПОСЛЕ ЗАПУСКА

- Отсоедините штепсель кабеля питания от розетки электросети.
- Отсоедините черный зарядный зажим от отрицательной клеммы аккумулятора (символ -), а красный зажим – от положительной клеммы аккумулятора (символ +).
- Поставьте зарядное устройство в сухое место.

6. СРЕДСТВА ЗАЩИТЫ ЗАРЯДНОГО УСТРОЙСТВА

Зарядное устройство защищено от:

- Перегрузки (подача слишком высокого тока на аккумулятор).
- Короткого замыкания (касание зарядных зажимов).
- Несоблюдения полярности клемм аккумулятора.

В устройствах, оснащенных предохранителем, при замене необходимо использовать аналогичные запчасти с таким же номинальным значением тока.

ВНИМАНИЕ: Использование предохранителя, номинал которого отличается от значения тока, указанного на табличке, может привести к травмированию людей или повреждению имущества. Поэтому категорически запрещено вместо предохранителей устанавливать перемычки из меди или других материалов. Во время замены предохранителя кабель питания всегда должен быть **ОТСОЕДИНЕН** от сети. Будьте внимательны при замене ленточных предохранителей, если они имеются, и крепко затягивайте крепежные гайки.

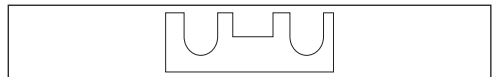

7. ПОЛЕЗНЫЕ СОВЕТЫ

- Очистите положительную и отрицательную клеммы от оксида, чтобы обеспечить хороший контакт с зажимами.
- Если аккумулятор, с которым предполагается использовать это зарядное устройство, постоянно установлен в транспортное средство, см. также главы "ЭЛЕКТРООБОРУДОВАНИЕ" или "ТЕХОБСЛУЖИВАНИЕ" в руководстве по эксплуатации и/или техобслуживанию транспортного средства.



ATENÇÃO: ANTES DE UTILIZAR O CARREGADOR LER O MANUAL DE INSTRUÇÕES ATENTAMENTE!

1. SEGURANÇA GERAL PARA O USO



- Evite o contacto com o ácido da bateria. Se porventura o ácido espirra ou se entra em contacto com o ácido, enxágue imediatamente a parte interessada com água limpa. Continue a enxaguar até a chegada do médico.



- Durante o carregamento as baterias emanam gases explosivos, evitar que se formem chamas e faíscas. **NÃO FUMAR.**
- Colocar as baterias que estão sendo carregadas num lugar ventilado.



- Proteja os olhos. Use sempre óculos de protecção quando trabalhar com acumuladores de chumbo ácido.



- Vista-se de maneira apropriada. Não use roupas largas ou jóias que possam se prender nas partes móveis. Durante os trabalhos recomenda-se o uso de roupas de protecção isoladas electricamente assim como de calçados antiderrapantes. No caso de cabelo comprido use toucas para prender o cabelo.



- As pessoas que não têm experiência devem ser instruídas oportunamente antes de utilizar o aparelho.
- O aparelho pode ser usado por crianças de idade não inferior a 8 anos e por pessoas com reduzidas capacidades físicas, sensoriais ou mentais, ou sem a experiência ou conhecimentos necessários, desde que sob vigilância ou depois de receberem instruções relativas ao uso seguro do aparelho e à compreensão dos perigos associados ao mesmo.
- As crianças não devem brincar com o aparelho.
- A limpeza e a manutenção destinadas a ser efetuadas pelo utilizador não devem ser efetuadas por crianças sem vigilância.
- Usar o carregador de baterias exclusivamente em locais fechados os quais devem ser ambientes bem ventilados: **NÃO EXPOR À CHUVA OU NEVE.**
- Desligar o cabo eléctrico da rede antes de ligar ou desligar os cabos de carga da bateria.
- Não prender nem desprender as pinças à bateria com o carregador de baterias funcionando.
- Não usar de maneira nenhuma o carregador de baterias dentro de um automóvel ou do capô.
- Substituir o cabo eléctrico somente com um cabo original.
- Se o cabo de alimentação estiver danificado, deve ser substituído pelo fabricante ou pelo seu serviço de assistência técnica ou por uma pessoa com qualificações semelhantes, de forma a prevenir qualquer risco.
- Não usar o carregador de baterias para recarregar baterias do tipo que não podem ser recarregadas.
- Verificar que a tensão de alimentação disponível seja correspondente àquela indicada na placa de dados do carregador de baterias.
- Para não danificar a electrónica dos veículos, respeite rigorosamente os avisos fornecidos pelos fabricantes dos veículos ou das baterias utilizadas.
- Este carregador de baterias contém partes, tais como interruptores ou relés, que podem provocar arcos ou faíscas; portanto se for usado numa garagem ou em ambiente semelhante, colocar o carregador de baterias num lugar ou caixa apropriada para tal fim.
- Operações de reparação ou de manutenção no interior do

carregador de baterias devem ser efectuadas somente por profissionais especializados.

- **ATENÇÃO: DESLIGAR SEMPRE O CABO ELÉCTRICO DA REDE ANTES DE EFECTUAR QUALQUER INTERVENÇÃO DE SIMPLES MANUTENÇÃO DO CARREGADOR DE BATERIAS, PERIGO!**
- O carregador de baterias é protegido por contatos indiretos mediante um condutor de terra, conforme prescrito para os aparelhos de classe I. Controlar que a tomada tenha ligação de protecção à terra.
- Nos modelos que forem equipados, ligue fichas com capacidade apropriada, não inferior, ao valor do fusível indicado na placa de dados.



- **Aparelho de classe A:**

Este carregador de baterias satisfaz os requisitos do standard técnico de produto para o uso em ambiente industrial e com finalidade profissional. Não é garantida a correspondência à compatibilidade eletromagnética nos edifícios domésticos e naqueles ligados diretamente a uma rede de alimentação de baixa tensão que alimenta os edifícios para o uso doméstico.

2. DESCRIÇÃO GERAL

Carregador de baterias apropriado para a carga de baterias de chumbo WET, EFB, GEL, AGM + (Ca) utilizadas em veículos a motor (gasolina e diesel) e veículos elétricos: automóveis, moto-veículos, motocicletas, embarcações, etc. É possível recarregar baterias de 12V, 24V; está prevista também a modalidade de arranque (apenas para os veículos com motores a gasolina e diesel).
Acumuladores recarregáveis em função da tensão de saída disponível: 12V / 6 células; 24V / 12 células.

3. INSTALAÇÃO

PREPARAÇÃO

- Desembale o carregador de bateria, efetue a montagem das partes soltas, contidas na embalagem.
- Os modelos com rodas devem ser instalados em posição vertical.

Pinça com pegas vermelhas montada com cabo móvel.
Pinça com pegas pretas montada com o cabo que sai direto do carregador de bateria.

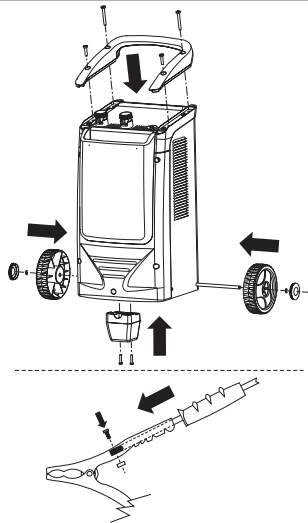

3.1 LOCALIZAÇÃO DO CARREGADOR DE BATERIAS

Durante o funcionamento, posicione de modo estável o carregador de baterias e verifique que a passagem de ar não fique obstruída através das aberturas apropriadas a fim de garantir uma ventilação suficiente.

3.2 LIGAÇÃO À REDE ELÉCTRICA

- O carregador de baterias deve ser ligado exclusivamente a um sistema de alimentação com condutor de neutro ligado à terra.
- Controle que a tensão da rede eléctrica corresponda à tensão de funcionamento do carregador de baterias, indicada na placa de dados.
- A linha de alimentação deverá ser equipada com sistemas de protecção, como fusíveis ou interruptores automáticos, suficientes para

suportar a absorção máxima do aparelho.

- A ligação à rede eléctrica deve ser efetuada com cabo de alimentação apropriado.
- Eventuais extensões do cabo de alimentação devem ter uma secção adequada e de qualquer forma nunca inferior àquela do cabo de alimentação do aparelho.
- É sempre obrigatório ligar o aparelho à terra, utilizando o condutor de cor amarelo-verde do cabo de alimentação, marcado pela etiqueta (↓), enquanto os outros dois condutores deverão ser ligados à fase e ao neutro da rede eléctrica de distribuição.

4. FUNCIONAMENTO EM CARGA

OBS.: Antes de efetuar a carga, verifique que a capacidade da bateria (Ah) que se quer colocar em carga não seja inferior àquela indicada na placa de dados do carregador de baterias (Cmin). As instruções devem ser seguidas rigorosamente segundo a ordem indicada abaixo.

4.1 PREPARAÇÃO DA BATERIA

Se a bateria a recarregar for do tipo WET efetue quanto segue:

- Remova as tampas da bateria (se presentes), de forma que os gases que são produzidos durante a carga possam sair. Controle que o nível do eletrólito cubra as placas da bateria; se estas estiverem descobertas adicione água destilada até mergulhá-las de 5 – 10 mm.



ATENÇÃO! TOME O MÁXIMO CUIDADO DURANTE ESTA OPERAÇÃO POIS O ELETRÓLITO É UM ÁCIDO ALTAMENTE CORROSIVO.

4.2 LIGAÇÃO DO CARREGADOR DE BATERIA/BATERIA

- Verificar se o cabo de alimentação está ligado à tomada de rede.
- Para os modelos com mais tensões de carga, posicionar o desviador ou o comutador em correspondência com a tensão de carga predefinida. Na ausência de desviador ou comutador, ligar adequadamente o cabo com pinça de carga vermelha (símbolo +) ao terminal específico do carregador de bateria em correspondência com a tensão de carga predefinida.
- Ligam a pinça de carga de cor vermelha ao terminal positivo da bateria (símbolo +). Se os símbolos não se distinguem lembra-se que o terminal positivo é aquele não ligado no chassis do veículo.
- Ligam a pinça de carga de cor preta ao chassis do veículo, longe da bateria e da mangueira do combustível.

NOTA: se a bateria não estiver instalada no veículo, ligar diretamente ao terminal negativo da bateria (símbolo -).

4.3 CARGA SIMULTÂNEA DE VÁRIAS BATERIAS

ATENÇÃO: não carregue baterias com capacidade, descarga e tipo diferentes entre si. Tendo que carregar várias baterias simultaneamente pode-se recorrer a ligações em “série” ou em “paralelo”:

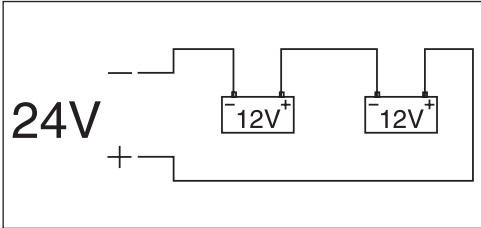

paralelo

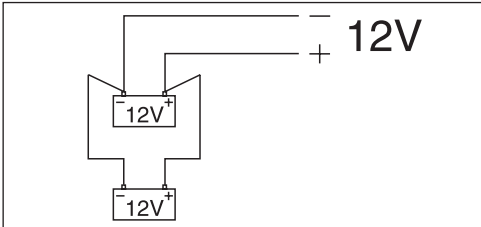

A ligação em “paralelo” exige que as baterias tenham a mesma tensão nominal (Volt), correspondente àquela na saída pelo carregador de baterias e que a soma dos Ah esteja incluída na faixa de carga do carregador de baterias.

A ligação em “série” exige que as baterias tenham a mesma capacidade

(Ah) e que a soma das tensões nominais de todas as baterias seja correspondente àquela na saída pelo carregador de bateria.

4.4 FIM DA CARGA

- Desligue a alimentação do carregador de baterias removendo a ficha do cabo de alimentação da tomada de rede eléctrica.
- Desprenda a pinça de carga de cor preta do chassis do veículo ou do borne negativo da bateria (símbolo -).
- Desprenda a pinça de carga de cor vermelha do borne positivo da bateria (símbolo +).
- Guarde o carregador de baterias em lugar seco.
- Feche as células da bateria com as tampas apropriadas (se presentes).

5. FUNCIONAMENTO EM ARRANQUE

ATENÇÃO: antes de proceder observe com atenção os avisos dos fabricantes de veículos!

- Certifique-se de proteger a linha de alimentação com fusíveis ou interruptores automáticos com o valor correspondente indicado na placa de dados com o símbolo (—).
- Para facilitar o arranque, efetue previamente uma carga rápida de 10-15 minutos, com carregador de baterias na posição de carga e NÃO de arranque.
- Se o veículo não arranca, espere alguns minutos e repita a operação de carga rápida. Não insista mais se o motor do veículo não arranca; com efeito, poderá comprometer seriamente a bateria ou até mesmo o equipamento elétrico do veículo.

5.1 LIGAÇÃO DO CARREGADOR DE BATERIA/BATERIA

- Antes de efetuar o arranque do veículo verifique que o valor de tensão nominal da bateria corresponda ao valor configurado no carregador de baterias.
- Verifique se a bateria está bem ligada nos respetivos terminais (+ e -), se as ligações na bateria estão corretas e se a bateria está em bom estado (não sulfatada e sem arvia).
- Não efetue de maneira nenhuma arranques de veículos com baterias desligadas dos respetivos terminais; a presença da bateria é determinante para a eliminação de eventuais sobrecargas de tensões por efeito da energia que poderá ser acumulada nos cabos de ligação durante as fases de arranque. **A falta de observação dessas disposições pode danificar a eletrônica do veículo.**

5.2 ARRANQUE

- Para selecionar esta função, consulte a ilustração “ARRANQUE”.

5.3 FIM DO ARRANQUE

- Remova a ficha do cabo de alimentação da tomada da rede de alimentação.
- Desprenda a pinça de carga de cor preta do terminal negativo da bateria (símbolo -) e a de cor vermelha do terminal positivo da bateria (símbolo +).
- Guarde o carregador de bateria em lugar seco.

6. PROTEÇÕES DO CARREGADOR DE BATERIA

O carregador de bateria está autoprotetido em caso de:

- Sobrecarga (excessivo fornecimento de corrente para a bateria).
- Curto-circuito (pinças de carga em contacto entre si).
- Inversão de polaridade nos terminais da bateria.

Nos aparelhos equipados com fusíveis, é obrigatório em caso de substituição, usar peças de substituição análogas com o mesmo valor de corrente nominal.



ATENÇÃO: Substituir o fusível com valores de corrente diferentes dos indicados na placa pode provocar danos a pessoas ou objetos. Pelo mesmo motivo, evitar de forma absoluta a substituição do fusível com pontos de cobre ou outro material. A operação de substituição do fusível deve ser sempre executada com o cabo de alimentação DESLIGADO da rede. Prestar atenção durante a substituição do fusível de fita, se presente, e apertar bem as porcas de fixação.

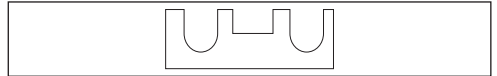

7. CONSELHOS ÚTEIS

- Limpe as possíveis incrustações de óxido nos terminais positivo e negativo de modo a garantir um bom contacto das pinças.
- Se a bateria na qual se quer utilizar este carregador de baterias está inserida permanentemente no veículo, consulte também o manual de instruções e/ou de manutenção do veículo no capítulo “INSTALAÇÃO ELÉTRICA” ou “MANUTENÇÃO”.



ΠΡΟΣΟΧΗ: ΠΡΙΝ ΧΡΗΣΙΜΟΠΟΙΗΣΕΤΕ ΤΟ ΦΟΡΤΙΣΤΗ ΜΠΑΤΑΡΙΩΝ ΔΙΑΒΑΣΤΕ ΠΡΟΣΕΚΤΙΚΑ ΤΟ ΕΓΧΕΙΡΙΔΙΟ ΧΡΗΣΗΣ!

1. ΓΕΝΙΚΗ ΑΣΦΑΛΕΙΑ ΓΙΑ ΤΗ ΧΡΗΣΗ



- Αποφεύγετε την επαφή με το οξύ της μπαταρίας. Σε περίπτωση πτώσεων ή επαφής με το οξύ, ξεπλύνετε αμέσως το ενδιαφερόμενο μέρος με καθαρό νερό. Συνεχίστε να ξεπλύνετε μέχρι να έρθει ο ιατρός.



- Κατά τη φόρτιση οι μπαταρίες εκπέμπουν εκρηκτικά αέρια, αποφεύγετε για αυτό να προκαλούνται φλόγες ή σπίθες. ΜΗΝ ΚΑΠΝΙΖΕΤΕ.
- Τοποθετείτε τις μπαταρίες που φορτίζονται σε αερισιμένο χώρο.



- Προστατεύετε τα μάτια. Φοράτε πάντα προστατευτικά γυαλιά όταν εργάζεστε με συσσωρευτές οξείας μολύβδου.



- Ντύνεστε κατάλληλα. Μην φοράτε φαρδιά ρούχα ή κοσμήματα που μπορούν να σκαλώσουν σε κινητά μέρη. Κατά την εργασία συνιστάται η χρήση προστατευτικής ενδυμασίας με ηλεκτρική μόνωση και αντιολισθητικών υποδημάτων. Σε περίπτωση μακρών μαλλιών φορέστε περιοριστικό κάλυμμα κεφαλής.



- Άτομα χωρίς πείρα πρέπει να ενημερώνονται κατάλληλα πριν χρησιμοποιήσουν τη μηχανή.
- Η συσκευή των 8 ετών και από άτομα με ελαττωμένες σωματικές, αισθητήριες ή διανοητικές ικανότητες, ή χωρίς πείρα ή κατάλληλη γνώση, εφόσον βρίσκονται υπό επίβλεψη ή έχουν λάβει οδηγίες για την ασφαλή χρήση της συσκευής και την κατανόηση των σχετικών κινδύνων.
- Τα παιδιά δεν πρέπει να παίζουν με τη συσκευή.
- Ο καθαρισμός και η συντήρηση που πρέπει να γίνονται από το χρήστη, δεν πρέπει να εκτελούνται από παιδιά χωρίς επίβλεψη.
- Χρησιμοποιείτε το φορτιστή μπαταριών αποκλειστικά σε εσωτερικούς χώρους και βεβαιωθείτε ότι ο ίδιος χώρος είναι αερισιμένος: ΜΗΝ ΕΚΘΕΤΕΣ ΣΕ ΒΡΟΧΗ Η ΧΙΟΝΙ.
- Αποσυνδέετε το καλώδιο τροφοδοσίας από το δίκτυο πριν συνδέσετε ή αποσυνδέσετε τα καλώδια φόρτισης της μπαταρίας.
- Μην συνδέετε ή αποσυνδέετε τις λαβίδες στην μπαταρία με το φορτιστή σε λειτουργία.
- Κατά απόλυτο τρόπο μην χρησιμοποιείτε το φορτιστή μπαταριών μέσα σε αυτοκίνητο ή μπουσούλο αυτοκινήτου.
- Αντικαταστήστε το καλώδιο τροφοδοσίας μόνο με αυθεντικό καλώδιο.
- Αν το καλώδιο τροφοδοσίας έχει υποστεί βλάβη, πρέπει να αντικατασταθεί από τον κατασκευαστή ή από τεχνικό του σέρβις ή πάντως από άτομο με παρόμοια ειδικότητα, ώστε να προλαμβάνονται όλοι οι κίνδυνοι.
- Μην χρησιμοποιήσετε το φορτιστή για τη φόρτιση μπαταριών του είδους που δεν φορτίζεται.
- Ελέγξτε ότι η διαθέσιμη τάση τροφοδοσίας αντιστοιχεί σε εκείνη που αναγράφεται στην τεχνική πινακίδα του φορτιστή.
- Για να μην βλάπτεται το ηλεκτρονικό σύστημα των οχημάτων, τηρήστε αυστηρά τις προειδοποιήσεις που χορηγούνται από τους κατασκευαστές των οχημάτων ή των χρησιμοποιούμενων μπαταριών.
- Αυτός ο φορτιστής μπαταριών περιλαμβάνει μέρη, όπως διακόπτες ή ρελέ, που μπορούν να παράγουν τόξα ή σπίθες. Για αυτό αν χρησιμοποιείται σε αμαρσοστάσιο ή παρόμοιο περιβάλλον, τοποθετήστε το φορτιστή σε κατάλληλο χώρο ή κατάλληλη θηκη.
- Επεμβάσεις επισκευής ή συντήρησης στο εσωτερικό του φορτιστή πρέπει να εκτελούνται μόνο από ειδικευμένο προσωπικό.

- **ΠΡΟΣΟΧΗ: ΑΠΟΣΥΝΔΕΤΕ ΠΑΝΤΑ ΤΟ ΚΑΛΩΔΙΟ ΤΡΟΦΟΔΟΣΙΑΣ ΑΠΟ ΤΟ ΔΙΚΤΥΟ ΠΡΙΝ ΕΚΤΕΛΕΣΕΤΕ ΟΠΟΙΑΔΗΠΟΤΕ ΕΠΕΜΒΑΣΗ ΑΠΛΗΣ ΣΥΝΤΗΡΗΣΗΣ ΣΤΟ ΦΟΡΤΙΣΤΗ, ΚΙΝΔΥΝΟΣ!**

- Ο φορτιστής μπαταριών προστατεύεται από έμμεσες επαφές μέσω αγωγού γείωσης σύμφωνα με τις προδιαγραφές για σκευές κατηγορίας I. Ελέγχετε ότι η πρίζα διαθέτει γείωση προστασίας.
- Στα μοντέλα που δεν είναι ήδη εφοδιασμένα, συνδέστε βύσματα κατάλληλης ικανότητας, όχι κατώτερης, της τιμής της ασφάλειας τήξης που αναγράφεται στην τεχνική πινακίδα.



- **Συσκευή κατηγορίας A:**

Αυτός ο φορτιστής ικανοποιεί τις απαιτήσεις του τεχνικού προτύπου προϊόντος για χρήση σε βιομηχανικό περιβάλλον και για επαγγελματικό σκοπό. Δεν εγγυάται η συμμόρφωση προς την ηλεκτρομαγνητική συμβατότητα σε οικιακά κτίρια και σε εκείνα που συνδέονται άμεσα σε δίκτυο τροφοδοσίας χαμηλής τάσης που τροφοδοτεί κτίρια για οικιακή χρήση.

2. ΓΕΝΙΚΗ ΠΕΡΙΓΡΑΦΗ

Φορτιστής μπαταρίας ενδεικνυόμενος για τη φόρτιση μπαταριών μολύβδου WET, EFB, GEL, AGM + (Ca) και μπαταρίες λιθίου Li που χρησιμοποιούνται σε μηχανοκίνητα οχήματα (βενζίνη και ντίζελ) και ηλεκτρικά οχήματα: αυτοκίνητα, μοτοσικλές, μοτοποδηλάτα, σκάφη, κλπ. Είναι δυνατή η επαναφόρτιση μπαταριών 12V, 24V. Προβλέπεται και ο τρόπος εκκίνησης (μόνο για οχήματα με κινητήρες βενζίνης και ντίζελ). Επαναφορτιζόμενοι συσσωρευτές σε συνάρτηση με τη διαθέσιμη τάση εξόδου: 12V / 6 κελιά, 24V / 12 κελιά.

3. ΕΓΚΑΤΑΣΤΑΣΗ

ΠΡΟΕΤΟΙΜΑΣΙΑ

- Αποσυσκευάστε τη γεννήτρια, εκτελέστε τη συναρμολόγηση των μεμονωμένων τμημάτων που περιέχονται στη συσκευασία.
- Τα μοντέλα με καρότι πρέπει να εγκατασταθούν σε κάθετη θέση.

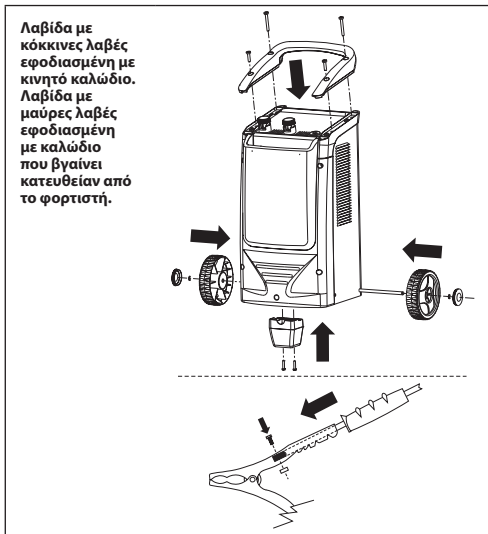

Λαβίδα με κόκκινες λαβές εφοδιασμένη με κινητό καλώδιο.
Λαβίδα με μαύρες λαβές εφοδιασμένη με καλώδιο που βγαίνει κατευθείαν από το φορτιστή.

3.1 ΤΟΠΟΘΕΤΗΣΗ ΤΟΥ ΦΟΡΤΙΣΤΗ

Κατά τη λειτουργία, τοποθετήστε το φορτιστή ώστε να είναι σταθερός και βεβαιωθείτε ότι δεν φράζεται το πέρασμα του αέρα από τις ειδικές σχισμές ώστε να εξαφασφιλίζεται ο απαραίτητος αερισμός.

3.2 ΣΥΝΔΕΣΗ ΣΤΟ ΗΛΕΚΤΡΙΚΟ ΔΙΚΤΥΟ

- Ο φορτιστής μπαταρίας πρέπει να συνδεθεί αποκλειστικά σε σύστημα τροφοδοσίας με γεωμεμένο ουδέτερο αγωγό.
- Βεβαιωθείτε ότι η τάση του ηλεκτρικού δικτύου αντιστοιχεί στην τάση λειτουργίας του φορτιστή μπαταρίας, που αναφέρεται στην τεχνική πινακίδα.
- Η γραμμή τροφοδοσίας θα πρέπει να εφοδιαστεί με συστήματα προστασίας, όπως ασφάλειες τήξης ή αυτόματους διακόπτες, επαρκείς ώστε να αντέχουν τη μέγιστη απορρόφηση της συσκευής.
- Η σύνδεση στο ηλεκτρικό δίκτυο πρέπει να εκτελεστεί με ειδικό καλώδιο τροφοδοσίας.

- Ενδεχόμενες προεκτάσεις του καλωδίου τροφοδοσίας πρέπει να έχουν κατάλληλη διατομή και πάντως ποτέ κατώτερη εκείνης του καλωδίου τροφοδοσίας της συσκευής.
- Είναι πάντα υποχρεωτικό να γειώνεται η συσκευή, χρησιμοποιώντας τον κίτρινο-πράσινο αγωγό του καλωδίου τροφοδοσίας, που σημαδεύεται από την ετικέτα (↓), ενώ οι άλλοι δυο αγωγοί θα πρέπει να συνδεθούν στη φάση και στο ουδέτερο του ηλεκτρικού δικτύου διανομής.

4. ΛΕΙΤΟΥΡΓΙΑ ΣΤΗ ΦΟΡΤΙΣΗ

ΠΡΟΣΟΧΗ: Πριν εκτελέσετε τη φόρτιση, βεβαιωθείτε ότι η χωρητικότητα της μπαταρίας (Ah) που θέλετε να φορτίσετε δεν είναι κατώτερη εκείνης που αναφέρεται στην τεχνική πινακίδα του φορτιστή (Cmin). Εκτελέστε τις οδηγίες ακολουθώντας αυστηρά την παρακάτω διάταξη.

4.1 ΠΡΟΕΤΟΙΜΑΣΙΑ ΜΠΑΤΑΡΙΑΣ

Αν η μπαταρία προς φόρτιση είναι τύπου WET, ενεργήστε ως εξής:

- Αφαιρέστε τα πώματα της μπαταρίας (αν υπάρχουν), ώστε να απελευθερώνονται τα αέρια που παράγονται κατά τη φόρτιση. Ελέγξτε ότι η στάθμη του ηλεκτρολύτη καλύπτει τις πλάκες της μπαταρίας. Αν αυτές προκλύπουν ακάλυπτες προσθέστε απεσταγμένο νερό μέχρι να βυθιστούν κατά 5 - 10 mm.



ΠΡΟΣΟΧΗ! ΔΩΣΤΕ ΤΗ ΜΕΓΑΛΥΤΕΡΗ ΠΡΟΣΟΧΗ ΚΑΤΑ ΤΗΝ ΕΝΕΡΓΕΙΑ ΑΥΤΗ ΔΙΟΤΙ Ο ΗΛΕΚΤΡΟΛΥΤΗΣ ΕΙΝΑΙ ΟΞΥ ΑΚΡΩΣ ΔΙΑΒΡΩΤΙΚΟ.

4.2 ΣΥΝΔΕΣΗ ΦΟΡΤΙΣΤΗΣ/ΜΠΑΤΑΡΙΑ

- Βεβαιωθείτε ότι το καλώδιο τροφοδοσίας είναι αποσυνδεδεμένο από την πρίζα δικτύου.
 - Για τα μοντέλα με περισσότερες τάσεις φόρτισης τοποθετήστε τον εκτροπέα ή το μετατροπέα στη θέση που αντιστοιχεί στην επιλεγμένη τάση φόρτισης. Αν δεν υπάρχει εκτροπέας ή μετατροπέας, συνδέστε κατάλληλα το καλώδιο με κόκκινη λαβίδα φόρτισης (σύμβολο +) στον ειδικό ακροδέκτη του φορτιστή στη θέση που αντιστοιχεί στην επιλεγμένη τάση φόρτισης.
 - Συνδέστε τη λαβίδα φορτίου κόκκινου χρώματος στο θετικό ακροδέκτη της μπαταρίας (σύμβολο +). Αν δεν ξεχωρίζετε τα σύμβολα υπενθυμίζεται ότι ο θετικός ακροδέκτης είναι εκείνος που δεν συνδέεται στο πλαίσιο του οχήματος.
 - Συνδέστε τη λαβίδα φορτίου μαύρου χρώματος στο πλαίσιο του οχήματος, μακριά από την μπαταρία και από τον αγωγό του καυσίμου.
- ΣΗΜΕΙΩΣΗ:** αν η μπαταρία δεν είναι εγκατεστημένη στο όχημα, συνδεθείτε κατευθείαν στον αρνητικό ακροδέκτη της μπαταρίας (σύμβολο -).

4.3 ΤΑΥΤΟΧΡΟΝΗ ΦΟΡΤΙΣΗ ΠΕΡΙΣΣΟΤΕΡΩΝ ΜΠΑΤΑΡΙΩΝ

ΠΡΟΣΟΧΗ: μην φορτίζετε μπαταρίες που να διαφέρουν μεταξύ τους σε χωρητικότητα, ικανότητα και τύπο. Αν πρέπει να φορτίσετε περισσότερες μπαταρίες ταυτόχρονα, μπορείτε να προσφύγετε σε συνδέσεις "σε σειρά" ή "παράλληλα":
σε σειρά

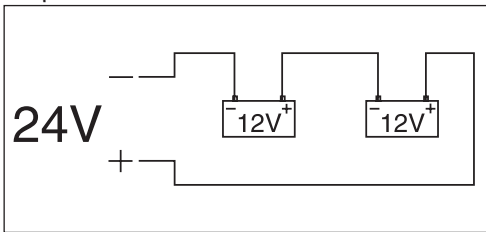

παράλληλα

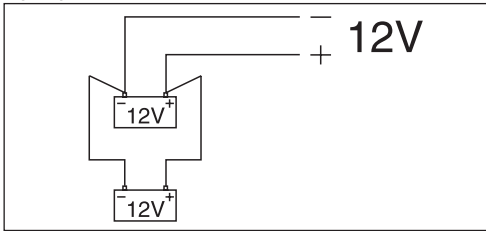

Για τη σύνδεση "παράλληλα" απαιτείται οι μπαταρίες να έχουν ίδια ονομαστική τάση (Volt), αντίστοιχη προς την εξερχόμενη από το φορτιστή καθώς και το άθροισμα των Ah να περιλαμβάνεται στην γκάμα φόρτισης του φορτιστή. Για τη σύνδεση "σε σειρά" απαιτείται οι μπαταρίες να έχουν την ίδια χωρητικότητα (Ah) καθώς και το άθροισμα των ονομαστικών τάσεων όλων των μπαταριών να αντιστοιχεί στην εξερχόμενη από το φορτιστή.

4.4 ΤΕΛΟΣ ΦΟΡΤΙΣΗΣ

- Βγάλτε την τροφοδοσία από το φορτιστή αφαιρώντας το βύσμα του καλωδίου τροφοδοσίας από την πρίζα ηλεκτρικού δικτύου.
- Αποσυνδέστε τη λαβίδα φορτίου μαύρου χρώματος από το πλαίσιο του οχήματος ή από τον αρνητικό ακροδέκτη της μπαταρίας (σύμβολο -).
- Αποσυνδέστε τη λαβίδα φορτίου κόκκινου χρώματος από το θετικό ακροδέκτη της μπαταρίας (σύμβολο +).
- Επανατοποθετήστε το φορτιστή σε στεγνό μέρος.
- Ξανακλείστε τα κύτταρα της μπαταρίας με τα ειδικά πώματα (αν υπάρχουν).

5. ΛΕΙΤΟΥΡΓΙΑ ΣΤΗΝ ΕΚΚΙΝΗΣΗ

ΠΡΟΣΟΧΗ: Πριν προχωρήσετε στις επόμενες ενέργειες τηρήστε προσεκτικά τις προειδοποιήσεις των κατασκευαστών οχημάτων!

- Εξασφαλίστε την προστασία της γραμμής τροφοδοσίας με ασφάλειες ή αυτόματους διακόπτες με τιμή αντίστοιχη προς την ενδεδειγμένη στην τεχνική πινακίδα με σύμβολο (—|—|—).
- Για να διευκολύνετε την εκκίνηση, εκτελέστε μια προκαταρκτική γρήγορη φόρτιση 10-15 λεπτών, με φορτιστή σε θέση φόρτισης και ΟΧΙ εκκίνησης.
- Αν δεν πραγματοποιείται η εκκίνηση του οχήματος, περιμένετε λίγα λεπτά και επαναλάβετε την ενέργεια γρήγορης φόρτισης. Μην επιμένετε πολύ αν ο κινητήρας του οχήματος δεν εκκινεί: θα μπορούσε, έτσι, να υποστεί σοβαρή βλάβη η μπαταρία ή ακόμα και η ηλεκτρική εγκατάσταση του οχήματος.

5.1 ΣΥΝΔΕΣΗ ΦΟΡΤΙΣΤΗΣ/ΜΠΑΤΑΡΙΑ

- Βεβαιωθείτε πριν προβείτε στην εκκίνηση του οχήματος ότι η τιμή ονομαστικής τάσης της μπαταρίας αντιστοιχεί στην τιμή που προοριώθηκε στο φορτιστή.
- Βεβαιωθείτε ότι η μπαταρία είναι καλά συνδεδεμένη στους αντίστοιχους ακροδέκτες (+ και -) και ότι οι συνδέσεις προς μπαταρία είναι σωστές καθώς και ότι η μπαταρία είναι σε καλή κατάσταση (όχι θεωμημένη ή αλλοιωμένη).
- Μην εκτελέτε κατά απόλυτο τρόπο εκκινήσεις οχημάτων με μπαταρίες αποσυνδεδεμένες από τους αντίστοιχους ακροδέκτες. Η παρουσία της μπαταρίας είναι καθοριστική για την αποφυγή ενδεχόμενων υπερτάσεων συνείσθησης της ενέργειας που θα μπορούσε να συσσωρευτεί στα καλώδια σύνδεσης κατά τις ενέργειες εκκίνησης. **Η μη τήρηση αυτών των διατάξεων θα μπορούσε να βλάψει τα ηλεκτρικά όργανα του οχήματος.**

5.2 ΕΚΚΙΝΗΣΗ

- Για την επιλογή αυτής της λειτουργίας, βλέπετε την εικόνα "ΕΚΚΙΝΗΣΗ".

5.3 ΤΕΛΟΣ ΕΚΚΙΝΗΣΗΣ

- Αφαιρέστε το βύσμα του καλωδίου τροφοδοσίας από την πρίζα του δικτύου τροφοδοσίας.
- Αποσυνδέστε τη λαβίδα μαύρου χρώματος από τον αρνητικό ακροδέκτη της μπαταρίας (σύμβολο -) και εκείνη κόκκινου χρώματος από το θετικό ακροδέκτη της μπαταρίας (σύμβολο +).
- Επανατοποθετήστε το φορτιστή σε στεγνό μέρος.

6. ΠΡΟΣΤΑΣΙΕΣ ΤΟΥ ΦΟΡΤΙΣΤΗ

Ο φορτιστής μπαταρίας αυτοπροστατεύεται σε περίπτωση:

- Υπερφόρτισης (υπερβολικής παροχής ρεύματος προς την μπαταρία).
- Βραχυκυκλώματος (λαβίδες φόρτισης που έρχονται σε επαφή μεταξύ τους).
- Αντιστροφή πολικότητας στους ακροδέκτες της μπαταρίας.

Στις συσκευές ως εφοδιάζονται με ασφάλειες είναι υποχρεωτική, σε περίπτωση αντικατάστασης ή χρήσης ομοίων ανταλλακτικών με ίδια τιμή ονομαστικού ρεύματος.



ΠΡΟΣΟΧΗ: Η αντικατάσταση της ασφάλειας με τιμές ρεύματος διαφορετικές από τις ενδεδειγμένες στην τεχνική πινακίδα θα μπορούσε να προκαλέσει βλάβες σε πρόσωπα ή πράγματα. Για τον ίδιο λόγο, αποφεύγετε κατά απόλυτο τρόπο την αντικατάσταση της ασφάλειας με γέφυρες από χαλκό ή άλλο υλικό. Η ενέργεια αντικατάστασης της ασφάλειας πρέπει να εκτελείται πάντα με το καλώδιο τροφοδοσίας ΑΠΟΣΥΝΔΕΔΕΜΕΝΟ από το δίκτυο. Προσέχετε κατά την αντικατάσταση της ασφάλειας λωρίδας, όπου υπάρχει, και ασφαλίστε σταθερά τα παξιμαδιά στερέωσης.

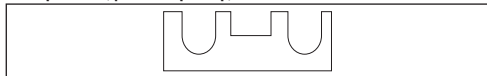

7. ΧΡΗΣΙΜΕΣ ΟΔΗΓΙΕΣ

- Καθαρίστε τους ακροδέκτες θετικό και αρνητικό από ενδεχόμενες επικαθίσεις οξειδίου ώστε να εγγυηθεί η καλή επαφή των λαβίδων.
- Αν η μπαταρία όπου θα χρησιμοποιήσετε αυτόν το φορτιστή είναι μόνιμα εγκατεστημένη στο όχημα, συμβουλευτείτε και το εγχειρίδιο χρήσης και/ή συντήρησης του οχήματος στο κεφάλαιο "ΗΛΕΚΤΡΙΚΗ ΕΓΚΑΤΑΣΤΑΣΗ" ή "ΣΥΝΤΗΡΗΣΗ".



OPGELET: VOORDAT MEN DE BATTERIJLADER GEBRUIKT, AANDACHTIG DE INSTRUCTIEHANDLEIDING LEZEN

1. ALGEMENE VEILIGHEID VOOR HET GEBRUIK



- Het contact met het zuur van de batterij vermijden. Ingeval men bespat wordt door of in contact komt met het zuur, het betrokken gedeelte onmiddellijk spoelen met zuiver water. Verder blijven spoelen tot de aankomst van de arts.



- Tijdens het opladen laten de batterijen explosief gas vrij, vermijd dat er zich vlammen en vonken vormen. NIET ROKEN.
- De op te laden batterijen op een verluchte plaats zetten.



- De ogen beschermen. Altijd een beschermende bril dragen wanneer men werkt met accu's met zuur lood.



- Zich op een gepaste manier kleden. Geen brede kleren of juwelen dragen die in de beweeglijke gedeeltes kunnen verstrikt geraken. Tijdens de werken raadt men het dragen van elektrisch geïsoleerde beschermende kledij en antislip schoenen aan. Voor wie lang haar heeft, een alles omvattend hoofddeksel dragen.



- De niet ervaren personen moeten op een adequate manier opgeleid worden voordat ze het toestel gebruiken.
- Het apparaat kan worden gebruikt door kinderen vanaf 8 jaar en door personen met beperkte fysieke, zintuiglijke of mentale capaciteit, door personen zonder ervaring of de benodigde kennis, mits deze onder toezicht staan of nadat deze instructies hebben gekregen over een veilig gebruik van het apparaat en over het begrip van de gevaren die met het apparaat gepaard gaan.
- Kinderen mogen niet met het apparaat spelen.
- De reiniging en het onderhoud dat door de gebruiker moeten worden uitgevoerd, mogen niet worden uitgevoerd door kinderen die niet onder toezicht staan.
- De batterijlader uitsluitend binnen gebruiken en werken in goed verluchte ruimten: NIET BLOOTSTELLEN AAN REGEN OF SNEEUW.
- De voedingskabel loskoppelen van het net voordat de kabels voor het opladen worden aangesloten op of losgekoppeld van de batterij.
- De tangen niet aansluiten op of loskoppelen van de batterij met de batterijlader in werking.
- De batterijlader geenszins gebruiken binnen in de auto of in de motorkap.
- De voedingskabel alleen vervangen met een originele kabel.
- Als het snoer is beschadigd, moet het worden vervangen door de fabrikant of diens technische dienst of in ieder geval door iemand met een dergelijke deskundigheid, om ieder risico te vermijden.
- De batterijlader niet gebruiken om niet heroplaadbare batterijen terug op te laden.
- Verifiëren of de beschikbare voedingsspanning overeenstemt met diegene die aangeduid staat op de plaat met de gegevens van de batterijlader.
- Om de elektronica van de voertuigen niet te beschadigen, de waarschuwingen geleverd door de fabrikanten van de voertuigen of van de gebruikte batterij strikt opvolgen.
- Deze batterijlader bevat componenten, zoals schakelaars of relais, die bogen of vonken kunnen veroorzaken; bijgevolg, indien de batterijlader in een garage of in een soortgelijke ruimte wordt gebruikt, moet men hem in een lokaal of in een omgeving plaatsen die speciaal voor dit doel bestemd is.
- Ingrepen van herstellingen of onderhoud aan de binnenkant van

de batterijlader mogen alleen uitgevoerd worden door personeel met ervaring.

- **OPGELET: DE VOEDINGSKABEL ALTIJD LOSKOPPELEN VAN HET NET VOORDAT MEN GELIJK WELKE INGREEP VAN GEWOON ONDERHOUD VAN DE BATTERIJLADER UITVOERT, GEVAAR!**
- De batterijlader is beschermd tegen indirecte contacten middels een aardegeleider zoals wordt voorgeschreven voor de toestellen van klasse I. Controleuren of het contact voorzien is van een beschermende aardeaansluiting.
- Sluit bij modellen die deze niet hebben stekkers met het juiste vermogen aan, niet minder dan de waarde van de zekering die staat aangegeven op het serieplaatje.



- Apparaatuur van klasse A:

Deze acculader voldoet aan de vereisten van de technische standaard van het gebruikte product in een industriële omgeving en voor professionele doeleinden. Er wordt niet gegarandeerd dat het product voldoet aan de elektromagnetische compatibiliteit in huizen en in gebouwen die direct zijn aangesloten op een voedingsnet met laagspanning voor huishoudelijk gebruik.

2. ALGEMENE BESCHRIJVING

Acculader voor het opladen van loodaccu's WET, EFB, GEL, AGM + (Ca) en lithiumaccu's, gebruikt in motorvoertuigen (benzine en diesel) en elektrische voertuigen: auto's, motorvoertuigen, motoren, boten, enz. Er kunnen accu's worden opgeladen van 12V, 24V; ook de startmodus is voorzien (alleen voor voertuigen met benzine- en dieselmotor).

Oplaadbare accu's op grond van de beschikbare uitgangsspanning: 12V / 6 cellen; 24V / 12 cellen.

3. INSTALLATIE

VOORBEREIDING

- De acculader uitpakken, de losse onderdelen die in de verpakking zitten monteren.
- Verrijdbare modellen moeten in verticale positie worden geïnstalleerd.

Klem met rode grepen gemonteerd met de mobiele kabel. Klem met zwarte grepen gemonteerd met de kabel die recht uit de acculader komt.

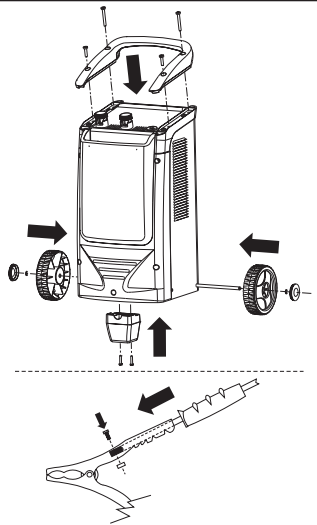

3.1 PLAATS VAN DE ACCULADER

Zorg er tijdens de werking voor dat de acculader stabiel staat en controleer of de lucht vrij door de luchtopeningen kan stromen zodat er voldoende ventilatie is.

3.2 AANSLUITEN OP HET ELEKTRICITEITSNET

- De acculader mag uitsluitend worden aangesloten op een voedingsstelsel waarvan de nulgeleider is aangesloten op de aarde.
- Controleer of de spanning van het elektriciteitsnet overeenkomt met de werkingsspanning van de acculader die op het serieplaatje staat.
- De voedingslijn moet voorzien zijn van beschermingsystemen, zoals zekeringen of automatische onderbrekers, die voldoende zijn voor het opnamemaximum van het apparaat.
- De acculader moet op het elektriciteitsnet worden aangesloten met

de speciale voedingskabel.

- Eventuele verlengingen van de voedingskabel moeten een voldoende doorsnede hebben en mogen nooit dunner zijn dan de voedingskabel van het apparaat.
- Het is altijd verplicht om het apparaat te aarden met de geel-groene geleider van de voedingskabel, waarop het etiket (↓) staat, terwijl de andere twee geleiders moeten worden aangesloten op fase en neutraal van het elektriciteitsnet.

4. WERKING TIJDENS HET LADEN

N.B.: Controleer voor het laden of de capaciteit van de accu (Ah) die moet worden opgeladen niet lager is dan de capaciteit die staat aangegeven op het serieplaatje van de acculader (Cmin). De instructies precies in de hieronder aangegeven volgorde uitvoeren.

4.1 DE ACCU VOORBEREIDEN

Als de op te laden accu van het type WET is, ga dan als volgt te werk:

- Verwijder de doppen van de accu's (indien aanwezig), zodat de gassen die worden geproduceerd tijdens het laden naar buiten kunnen. Controleer of het elektrolytpeil de accuplaatjes bedekt; als deze bloot liggen, gedestilleerd water toevoegen totdat ze 5-10 mm onder staan.



OPGELET! WEES ZEER VOORZICHTIG TIJDENS DEZE HANDELING OMDAT ELEKTROLYT EEN STERK CORROSIEF ZUUR IS.

4.2 AANSLUITING ACCULADER/ACCU

- Controleren of de voedingskabel uit het stopcontact is gehaald.
- Bij modellen met meerdere laadspanningen de schakelaar of de knop op de gewenste laadspanning plaatsen. Als er geen schakelaar of knop is de kabel met rode laadklem (symbool +) op de juiste manier aansluiten op de specifieke klem van de acculader bij de gewenste laadspanning.
- De rode laadklem aansluiten op de positieve klem van de accu (symbool +). Als de symbolen niet te onderscheiden zijn, onthoud dan dat de positieve klem de klem is die niet is aangesloten op het chassis van de auto.
- De zwarte laadklem aansluiten op het chassis van het voertuig, ver weg van de accu en de brandstofleiding.
LET OP: als de accu niet in de auto is geïnstalleerd, direct aansluiten op de negatieve klem van de accu (symbool -).

4.3 GELIJKTIJDIG MEERDERE ACCU'S LADEN

OPGELET: geen accu's opladen met verschillende vermogens, ladingen en van verschillende types. Als u tegelijkertijd meerdere accu's moet opladen, kunt u deze in "serie" of "parallel" verbinden: serie

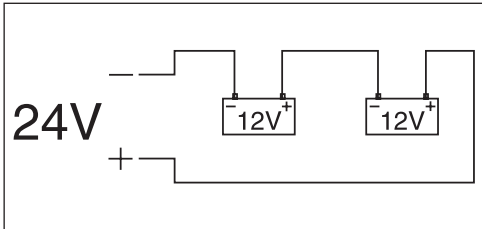

parallel

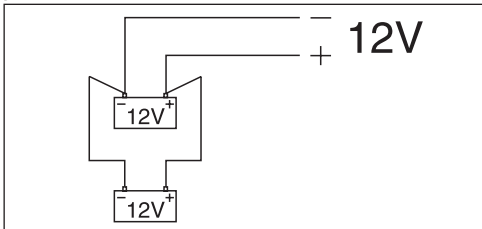

Om de accu's "parallel" te verbinden, moeten ze dezelfde nominale spanning (Volt) hebben, die overeenkomt met de uitgangsspanning uit de acculader en moet de som van de Ah's binnen het laadbereik van de acculader liggen.

Om de accu's in "serie" te schakelen, moeten ze hetzelfde vermogen (Ah) hebben en moet de som van de nominale spanningen van alle accu's overeenkomen met de uitgangsspanning uit de acculader.

4.4. EINDE LADEN

- De voeding van de acculader loskoppelen door de stekker van de voedingskabel uit het stopcontact te halen.
- De zwarte laadklem loskoppelen van het chassis van het voertuig of van de negatieve klem van de accu (symbool -).
- De rode laadklem loskoppelen van de positieve klem van de accu (symbool +).
- De acculader op een droge plaats neerzetten.
- De accucellen sluiten met de speciale doppen (indien aanwezig).

5. WERKING BIJ HET STARTEN

OPGELET: neem voordat u begint nauwkeurig de waarschuwingen van de constructeurs van de voertuigen in acht!

- Zorg ervoor dat de voedingsleiding wordt beschermd met zekeringen of automatische onderbrekers met de waarde die op het serieplaatje staat aangegeven met het symbool (—|—).
- Voor gebruik als starthulp de accu eerst 10-15 minuten snel opladen, met de acculader in de laadpositie en NIET in de startpositie.
- Als het voertuig niet start, wacht dan enkele minuten en herhaal de snelle laadprocedure. Niet doorgaan als de motor van het voertuig niet start: als u dat wel doet, kan de accu of zelfs de elektronica van het voertuig ernstig beschadigen raken.

5.1 AANSLUITING ACCULADER/ACCU

- Controleer voordat het voertuig wordt gestart of de nominale spanningswaarde van de accu overeenkomt met de op de acculader ingestelde waarde.
- Controleer of de accu goed op de klemmen (+ en -) is aangesloten, of de aansluitingen op de accu goed zijn uitgevoerd en of de accu in goede staat is (niet gesulfateerd en niet defect).
- Laat absoluut geen voertuigen starten waarvan de accu's niet op de klemmen zijn aangesloten; de aanwezigheid van de accu is bepalend voor het opheffen van eventuele overspanning door de energie die zich kan ophopen in de aansluitkabels tijdens de startfasen. **Als u deze voorschriften niet in acht neemt, kan de elektronica van het voertuig beschadigen.**

5.2 STARTEN

- Raadpleeg de tekening "STARTEN" voor het selecteren van deze functie.

5.3 EINDE STARTEN

- Haal de stekker van de voedingskabel uit het stopcontact.
- Koppel de zwarte laadklem los van de negatieve klem van de accu (symbool -) en de rode laadklem van de positieve klem van de accu (symbool +).
- De acculader op een droge plaats neerzetten.

6. BEVEILIGINGEN VAN DE ACCULADER

De acculader beschermt zichzelf in het geval van:

- Overbelasting (teveel afgifte van stroom naar de accu).
- Kortsluiting (laadklemmen zijn met elkaar in contact gekomen).
- Omkering van de polariteit van de accuklemmen.

Bij apparaten met zekeringen is het in het geval van vervanging verplicht om gelijksoortige reserveonderdelen te gebruiken met dezelfde nominale stroomwaarde.



OPGELET: Het vervangen van de zekering met andere stroomwaarden dan die staan aangegeven op het serieplaatje kan schade aan personen of voorwerpen veroorzaken. Om dezelfde reden mag de zekering absoluut niet worden vervangen door jumpers van koper of andere materialen. Het vervangen van de zekering moet altijd worden uitgevoerd met de voedingskabel LOSGEKOPPELD van het netwerk. Wees voorzichtig bij het vervangen van de stripzekering, indien aanwezig, en draai de borgmoeren stevig vast.

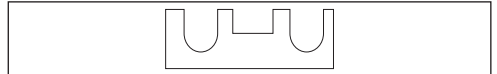

7. NUTTIGE TIPS

- Verwijder eventuele roestplekken van de positieve en negatieve klem zodat de klemmen goed contact blijven maken.
- Als de accu waarmee u deze acculader wilt gebruiken permanent in het voertuig is geïnstalleerd, raadpleeg dan ook het gedeelte "ELEKTRISCHE INSTALLATIE" of "ONDERHOUD" van de instructie- en/of onderhoudshandleiding van het voertuig.



FIGYELEM: AZ AKKUMULÁTORTÖLTŐ HASZNÁLATA ELŐTT FIGYELMESEN OLVASSA EL A HASZNÁLATI UTASÍTÁST!

1. ÁLTALÁNOS HASZNÁLATI BIZTONSÁGI ELŐÍRÁSOK



- Kerülje az akkumulátorsavval való érintkezést. Abban az esetben, ha magára fröccsent a sav vagy azzal érintkezésbe került, akkor tiszta vízzel azonnal öblítse le az érintett részt. Folytassa az öblítést addig, amíg az orvos meg nem érkezik.



- Az akkumulátor töltése alatt robbanógázok jönnek létre, el kell kerülni láng és szikrák keletkezését. **TILOS A DOHÁNYZÁS.**
- A töltés alatt álló akkumulátorokat jól szellőző helyen kell elhelyezni.



- Óvja a szemét. Mindig viseljen védőszemüveget, amikor savas ólomakkumulátorokkal dolgozik.



- Az alkalomnak megfelelően öltözködjön. Ne viseljen bő ruhákat vagy ékszereket, amelyek a mozgó részek közé beszorulhatnak. A munkavégzés folyamán elektromos szigetelt védőruhákat valamint csúszásgátló cipő használatát javasolt. Hosszú hajzat esetén a haját takaró sapkát viseljen.



- A tapasztalatlan személyeket idejében, a készülék használatba vétele előtt be kell tanítani.
- A készülékelt 8 évesnél nagyobb gyermekek és csökkent fizikai, érzékszervi vagy szellemi képességű, illetve tapasztalattal és a szükséges ismeretekkel nem rendelkező személyek felügyelet mellett használhatják, vagy azt követően, hogy a készülék biztonságos használatára vonatkozó utasításokat megkapták és az azzal kapcsolatos veszélyeket megértették.
- A gyermekek nem játszhatnak a készülékkel.
- A felhasználó által elvégezendő tisztítást és karbantartást gyermekek felügyelet nélkül nem hajthatják végre.
- Az akkumulátortöltőt kizárólag zárt, jól szellőző helyiségben üzemeltethető. **A BEREZDÉS ESŐNEK VAGY HÓNÁK NEM TEHETŐ KI.**
- A töltőberendezés kábeleinek az akkumulátorhoz való csatlakoztatása vagy az azzal már létrejött csatlakozás megszakítása előtt az áramellátási kábel és a hálózat közötti kapcsolatot meg kell szakítani.
- Ne hozzon létre csatlakozást a fogók és az akkumulátor között, valamint ne szakítsa meg a már létrehozott ilyen csatlakozást az akkumulátortöltő üzemelésének ideje alatt.
- Ne használja az akkumulátortöltőt személygépkocsi, vagy a motorháztető tereén belül.
- Az áramellátási kábel eredeti kábellel helyettesíthető.
- Ha a tápkábel sérült, akkor azt a gyártónak vagy a műszaki szervizszolgálatának vagy mindenestre hasonló szakképesítéssel rendelkező személynek kell elvégeznie bármiféle kockázat megelőzése érdekében.
- Ne használja az akkumulátortöltőt nem tölthető akkumulátorok töltésére.
- Ellenőrizni kell, hogy a rendelkezésre álló áramellátási feszültség megfelel-e az akkumulátortöltő adat-tábláján feltüntetettnek.
- A jármű elektronika megrongálódásának elkerülése végett szigorúan tartsa be a jármű vagy a felhasznált akkumulátorok gyártói által nyújtott utasításokat.
- Ehhez az akkumulátortöltőhöz olyan alkatrészek tartoznak, nevezetesen a megszakítók vagy a relé, melyek iverk vagy szikrák létrejöttét idézhetik elő még akkor is, ha üzemeltetése garázsban vagy ahhoz hasonló helyiségben történik; az akkumulátortöltőt a

célnak megfelelő helyen vagy tartóban kell tárolni.

- Az akkumulátortöltő belsejében javítási, vagy karbantartási műveleteket kizárólag szakértő személy végezhet.
- **FIGYELEM: AZ AKKUMULÁTORTÖLTŐ BÄRMELY EGYSZERÜ KARBANTARTÁSI MÜVELETÉNEK VÉGREHAJTÁSA ELÖTT MEG KELL SZAKÍTANI AZ ÁRAMELLÁTÁSI KÁBEL KAPCSOLATÁT A HÁLÓZATTAL, MERT AZ VESZÉLYES LEHET!**
- Az akkumulátortöltő egy földvezeték által védett a közvetett érintkezésektől, az I. osztályú készülékek számára előírtaknak megfelelően. Ellenőrizze, hogy a csatlakozón van biztonsági földelő összeköttetés.
- Azoknál a modelleknél, amelyek csatlakozódugóval nincsenek ellátva, csatlakoztasson az adattáblán megjelölt biztosíték értékének megfelelő és annál nem kisebb terhelésű csatlakozódugókat.



- **A osztályú berendezés:**

Ez az akkumulátortöltő megfelel azon műszaki termékszabvány követelményeinek, amely meghatározza az ipari környezetben és a professzionális célból való felhasználást. Nem biztosított az elektromágneses kompatibilitásnak való megfelelése a lakóépületekben és a háztartási célú használatra az épületeket ellátó, kifeszültségű táphálózathoz közvetlenül csatlakoztatott épületekben.

2. ÁLTALÁNOS LEÍRÁS

Akkumulátortöltő, amely motoros járműveken (benzines és dízel) és elektromos járműveken: autókön, gépjárműveken, motorkerékpárokon, hajókön, stb. használatos WET, EFB, GEL, AGM + (Ca) ólomakkumulátorok és lítiumos Li akkumulátorok feltöltéséhez javasolt. 12V-s, 24V-s akkumulátorokat lehet feltölteni; rendelkezésre áll az indító funkció is (csak a benzín- és dízelmotoros járművek számára).
A rendelkezésre álló kimeneti feszültség függvényében újratölthető akkumulátorok: 12V / 6 cella; 24V / 12 cella.

3. ÖSSZESZERELÉS

ÖSSZEÁLLÍTÁS

- Csomagolja ki az akkumulátortöltőt, végezze el a csomag tartalmát képező, különálló részek összeszerelését.
- A kocsival ellátott modelleket függőleges pozícióban kell összeszerelni.

Mozgó kábelhez erősített, piros fogantyús csipesz. Egyenesen az akkumulátortöltőből kijövő kábelhez erősített, fekete fogantyús csipesz.

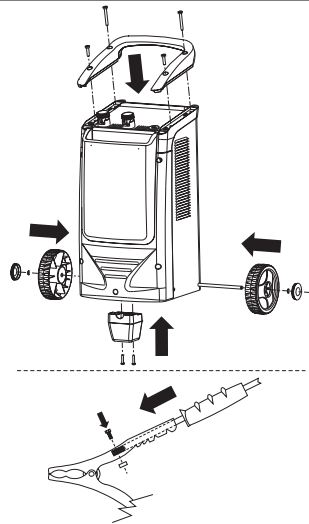

3.1 AZ AKKUMULÁTORTÖLTŐ ELHELYEZÉSE

A működés folyamán stabilan helyezze el az akkumulátortöltőt és győződjön meg arról, hogy nem zárta el a megfelelő szellőzőnyílásokon keresztül átáramló levegő útját, biztosítva ezáltal a elegendő szellőzést.

3.2 CSATLAKOZTATÁS AZ ELEKTROMOS HÁLÓZATHOZ

- Az akkumulátortöltőt kizárólag egy földelt, semleges vezetékkel kell egy táprendszerbe csatlakoztatni.
- Ellenőrizze, hogy az elektromos hálózati feszültség megfelel-

az akkumulátortöltő adattáblázatában feltüntetett, működési feszültségnek.

- A tápvonalnak olyan védelmi rendszerekkel kell rendelkeznie, mint biztosítékok vagy automata megszakítók, amelyek alkalmasak a készülék maximális áramfelvételének elviseléséhez.
- Az elektromos hálózathoz való csatlakoztatást arra alkalmas tápkábelrel kell elvégezni.
- Az esetleges tápkábel-hosszabbítók a készülék tápkábelének megfelelő és mindenesetre annál sohasem kisebb keresztmetszetűek legyenek.
- Mindig kötelező a készüléket a földhöz csatlakoztatni a tápkábel sárga-zöld színű vezetékének használatával, amelyet a címke (↓) különböztet meg, míg a másik két vezeték az elektromos áramszolgáltató hálózat fázisába és a semleges pólusába kell bekötöni.

4. TÖLTÉSI ÜZEMMÓD

MEGJ.: A töltés megkezdése előtt ellenőrizni kell, hogy a feltöltendő akkumulátor kapacitása (Ah) nem kisebb az akkumulátortöltő adattábláján feltüntetetté (Cmin). Hajtsa végre az utasításokat az alul feltüntetett sorrend gondos betartása mellett.

4.1 AKKUMULÁTOR ELŐKÉSZÍTÉSE

Ha a feltöltendő akkumulátor WET típusú, akkor az alábbiak szerint járjon el:

- Távolítsa el az akkumulátor dugóit (ha vannak), így a töltés folyamán képződő gázok kiáramolhatnak. Ellenőrizze, hogy az elektrolit szintje ellepje az akkumulátor lemezeket; ha azok nincsenek takarva, akkor öntsön be annyi desztillált vizet, hogy a lemezek 5 -10 mm-ig belemérüljenek.



FIGYELEM! A LEGNAGYOBB ÓVATOSSÁGGAL JÁRJON EL E MŰVELET FOLYAMÁN, MIVEL AZ ELEKTROLIT EGY NAGYMÉRTEKBEN KORROZÍV HATÁSÚ SAV.

4.2 AKKUMULÁTORTÖLTŐ/AKKUMULÁTOR CSATLAKOZTATÁSA

- Ellenőrizze, hogy a tápkábel ki legyen húzva a hálózati aljzatról.
- A több töltőfeszültséggel rendelkező modellnek állítsa a váltókapcsolót vagy az átkapcsolót az előre kiválasztott, töltőfeszültségnek megfelelő állásba. Váltókapcsoló vagy átkapcsoló hiányában megfelelően csatlakoztassa a piros töltőcsipeszes kábelt (+ jel) az akkumulátortöltő specifikus sarujához, az előre kiválasztott töltőfeszültség függvényében.
- Csatlakoztassa a piros színű töltőcsipeszt az akkumulátor pozitív sarujához (+ jel). Ha a jelek nem különböztethetők meg, akkor emlékezzen arra, hogy a pozitív saru az, amelyik nincs csatlakoztatva a gép vázához.
- Csatlakoztassa a fekete színű töltőcsipeszt a gépkocsi vázához, az akkumulátortól és az üzemanyagcsőtől távol.

MEGJEGYZÉS: ha az akkumulátor nincs beszerelve a gépkocsiba, akkor csatlakoztassa közvetlenül az akkumulátor negatív sarujához (- jel).

4.3 TÖBB AKKUMULÁTOR EGYIDEJŰ TÖLTÉSE

FIGYELEM: ne töltson különböző kapacitású, típusú és lemerültségű akkumulátorokat. Amennyiben egyidejűleg több akkumulátort kell tölteni, akkor lehet „soros” vagy „párhuzamos” bekötésekhez folyamodni:

soros

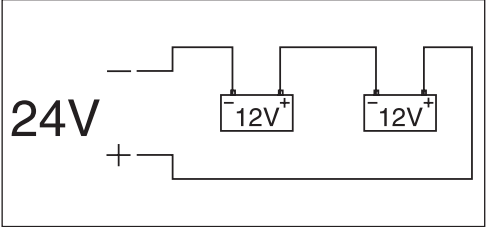

párhuzamos

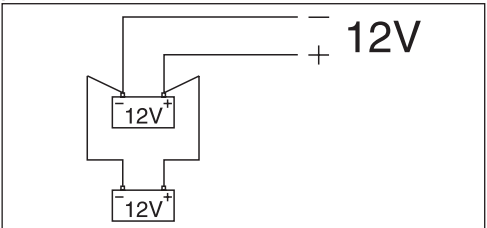

A „párhuzamos” bekötés azt igényli, hogy az akkumulátorok ugyanazon névleges feszültséggel rendelkezzenek (Volt), amely megfelel az

akkumulátortöltőből kilépő feszültségnek és az Ah-k összege az akkumulátortöltő töltési tartományában legyen.

A „soros” bekötés azt igényli, hogy az akkumulátorok ugyanazon kapacitással rendelkezzenek (Ah) és minden akkumulátor névleges feszültségének összege megfeleljen az akkumulátortöltőből kilépő feszültségnek.

4.4 TÖLTÉS VÉGE

- Vegye le az áramot az akkumulátortöltőről úgy, hogy húzza ki a tápkábel csatlakozódugóját az elektromos hálózathoz csatlakozóaljzatról.
- Csatlakoztassa ki a fekete színű töltőcsipeszt a jármű vázából vagy az akkumulátor negatív sarujából (- jel).
- Csatlakoztassa ki a piros színű töltőcsipeszt az akkumulátor pozitív sarujából (+ jel).
- Helyezze el az akkumulátortöltőt egy száraz helyre.
- Zárja vissza az akkumulátor celláit a megfelelő dugókkal (ha vannak).

5. BEINDÍTÓ MŰKÖDÉS

FIGYELEM: A művelet megkezdése előtt figyelmesen olvassa el a járművek gyártóinak figyelmeztetéseit!

- Győződjön meg arról, hogy a tápvonal védve van az adattáblán (—) jellel jelölt, megfelelő értékű biztosítékokkal vagy automata megszakítókkal.
- Az indítás elősegítéséhez előzőleg végezzen el egy 10-15 perces gyors töltést úgy, hogy az akkumulátortöltő a töltés és NEM az indítás pozícióba van állítva.
- Ha a jármű nem indul be, akkor várjon néhány percet és ismételje meg a gyors töltési műveletet. Ha a jármű motorja nem indul be, ne erőltesse az indítást; komolyan veszélyeztetheti az akkumulátor vagy akár a jármű elektromos berendezésének épségét.

5.1 AKKUMULÁTORTÖLTŐ/AKKUMULÁTOR CSATLAKOZTATÁSA

- A jármű beindításának végrehajtása előtt győződjön meg arról, hogy az akkumulátor névleges feszültségi értéke megfelel az akkumulátortöltőben beállított értéknek.
- Győződjön meg arról, hogy az akkumulátor helyesen van csatlakoztatva a megfelelő sarukhoz (+ és -), az akkumulátor felé irányuló csatlakozások helyesek és az akkumulátor jó állapotban van (nem szulfátosodott és nem rossz).
- Semmilyen esetre se indítsa be a járműveket akkor, ha az akkumulátorok ki vannak csatlakoztatva a vonatkozó sarukból; az akkumulátor jelenléte alapvető fontosságú az olyan energia hatására kialakuló, esetleges túlfeszültségek kiküszöböléséhez, amelyek a csatlakozókábelekben összegyűlhetnek az indítási fázis folyamán. **Ezen előírások figyelmen kívül hagyása károsíthatja a jármű elektronikáját.**

5.2 BEINDÍTÁS

- E funkció kiválasztásához lásd a "BEINDÍTÁS" illusztrációját.

5.3 INDÍTÁS VÉGE

- Húzza ki a tápkábel csatlakozódugóját a táphálózat csatlakozóaljzatról.
- Csatlakoztassa ki a fekete színű töltőcsipeszt az akkumulátor negatív sarujából (- jel) és a piros színű töltőcsipeszt az akkumulátor pozitív sarujából (+ jel).
- Helyezze el az akkumulátortöltőt egy száraz helyre.

6. AZ AKKUMULÁTORTÖLTŐ VÉDELMEI

Az akkumulátortöltő önvédelemmel van ellátva az alábbi esetekben:

- Túltöltés (túl sok áram küldése az akkumulátor felé).
- Rövidzárlat (töltő csipeszek egymáshoz érintése).
- A polaritás felcserélése az akkumulátor sarkainál.
- A biztosítékokkal ellátott berendezéseknél csere esetén olyan hasonló cserelétrészek használata kötelező, amelyek névleges áramértéke ugyanaz.



FIGYELEM: Az adattáblán megjelöltéktől eltérő áramértékekkel rendelkező biztosítékok alkalmazása személyekben vagy dolgokban károkat okozhat. Ugyanilyen oknál fogva szigorúan tilos a biztosítéktól kicserélése réz áthidalásokra vagy egyéb anyagra. A biztosítéktól kicserélési műveletet mindig a hálózatról KIHÚZOTT tápkábelrel kell elvégezni. Figyelemmel járjon el a biztosítéktól szalag kicserélése folyamán, ha van, és erősen húzza meg a rögzítő csavaranyákat.

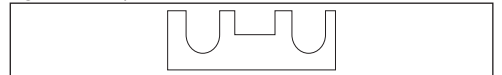

7. HASZNOS TANÁCSOK

- Tisztítsa meg a pozitív és negatív sarukat az esetleges oxidlerakódásoktól, biztosítva ily módon a csipeszek jó érintkezését.
- Ha az akkumulátor, amelyhez az akkumulátortöltőt használni kívánja, tartósan be van szerelve a járműbe, akkor olvassa el a jármű használati és/vagy karbantartási kézikönyvében az "ELEKTROMOS RENDSZER" vagy "KARBANTARTÁS" című alatt leírtakat.



ATENȚIE: ÎNAINTE DE FOLOSIREA REDRESORULUI CITIȚI CU ATENȚIE MANUALUL DE INSTRUCȚIUNI!

1. SIGURANȚA GENERALĂ PENTRU FOLOSIRE



- Evitați contactul cu acidul bateriei. În cazul în care vă stropiți sau intrați în contact cu acidul, clătiți imediat partea afectată cu apă curată. Continuați să clătiți până la sosirea medicului.



- În timpul încărcării se emană gaz exploziv, evitați flăcările deschise și formarea scântei. FUMATUL INTERZIS.
- Poziționați bateriile în încărcător într-un spațiu aerisit.



- Protejați ochii. Purtați întotdeauna ochelari de protecție atunci când lucrați cu acumulatori cu plumb acid.



- Îmbrăcați-vă în mod corespunzător. Nu purtați haine largi sau bijuterii, ce se pot prinde în părțile în mișcare. În timpul lucrului, se recomandă folosirea unor haine de protecție izolate din punct de vedere electric, ca și a încălțămintei anti-derapante. În cazul în care aveți părul lung, purtați căștile speciale pentru păr.



- Persoanele fără experiență trebuie să fie instruite corespunzător înainte de a folosi aparatul.
- Aparatul poate fi utilizat de copiii în vârstă de peste 8 ani și de persoane cu capacități fizice, senzoriale sau mentale reduse sau fără experiența sau cunoștințele necesare, cu condiția să fie sub supraveghere sau după ce au primit instrucțiuni privind folosirea sigură a aparatului și înțelegerea pericolelor inerente acestuia.
- Copiii nu trebuie să se joace cu aparatul.
- Curățarea și întreținerea care se efectuează de către utilizator nu trebuie efectuată de copiii nesupraveheați.
- Folosiți încărcătorul de baterii exclusiv în interior și asigurați-vă că acesta funcționează în medii bine aerisite. **NU EXPUNEȚI APARATUL LA PLOI SAU LA ZĂPADĂ.**
- Deconectați cablul de alimentare de la rețea înainte de a conecta sau a deconecta cablurile de încărcare de la baterie.
- Nu conectați sau deconectați clemele încărcătorului la/de la bornele bateriei cu acesta în funcțiune.
- Nu folosiți niciodată încărcătorul de baterii în interiorul unui vehicul sau al portbagajului.
- Înlocuiți cablul de alimentare numai cu un cablu original.
- În cazul în care cablul de alimentare este deteriorat, acesta trebuie să fie înlocuit de fabricant sau de serviciul acestuia de asistență tehnică sau, oricum, de către o persoană cu o calificare similară, pentru a preveni orice risc.
- Nu folosiți încărcătorul de baterii pentru baterii care nu sunt reincărcabile.
- Verificați ca tensiunea de alimentare disponibilă să corespundă cu cea indicată pe placa indicatoare a aparatului.
- Pentru a nu deteriora partea electronică a vehiculelor, respectați cu atenție recomandările furnizate de fabricanții vehiculelor sau ai bateriilor utilizate.
- Acest încărcător de baterii conține părți precum întrerupători sau releu, care pot provoca arcuri sau scântei; de aceea în cazul în care se utilizează într-un garaj sau într-un mediu similar, amplasați aparatul într-un spațiu izolat sau protejați-l cu o acoperitoare adecvată.
- Orice intervenție de reparație sau de întreținere în interiorul încărcătorului de baterii trebuie să fie efectuată numai de către personal calificat.
- **ATENȚIE: DECONECTAȚI ÎNTOTDEAUNA CABLUL DE ALIMENTARE DE LA REȚEA ÎNAINTE DE A EFECTUA ORICE SIMPLĂ INTERVENȚIE**

DE ÎNTREȚINERE A ÎNCĂRCĂTORULUI DE BATERII. PERICOL!

- Încărcătorul de baterii este protejat de contacte indirecte printr-un conductor de împământare potrivit prescripțiilor pentru aparatele de clasă I. Verificați ca priză să dispună de o legătură de protecție de punere la pământ.
- La modelele în care nu sunt prevăzute, conectați ștechere cu o capacitate corespunzătoare, nu inferioară, valorii siguranței fuzibile indicate pe placa de date.



- Aparat de clasă A:

Acest încărcător corespunde cerințelor standardului tehnic de produs pentru folosirea exclusivă în medii industriale și în scop profesional. Nu este asigurată coerența cu compatibilitatea electromagnetă în clădirile de locuință și în cele conectate direct la o rețea de alimentare de joasă tensiune care alimentează clădirile pentru uzul casnic.

2. DESCRIERE GENERALĂ

Încărcător indicat pentru încărcarea bateriilor cu plumb WET, EFB, GEL, AGM + (Ca) și a bateriilor cu litiu Li utilizate la vehiculele cu motor (benzină și motorină) și la vehiculele electrice: automobile, motociclete, ambarcațiuni etc. Se pot încărca baterii de 12V, 24V; este prevăzută și modalitatea de pornire (doar pentru vehiculele cu motoare pe benzină și motorină).

Accumulatorul reincărcabil în funcție de tensiunea de ieșire disponibilă: 12V / 6 celule; 24V / 12 celule.

3. INSTALAREA PREGĂTIREA

- Dezambalați încărcătorul, efectuați montajul părților desprinse, conținute în ambalaj.
- Modelele cu cărucior trebuie să fie instalate în poziție verticală.

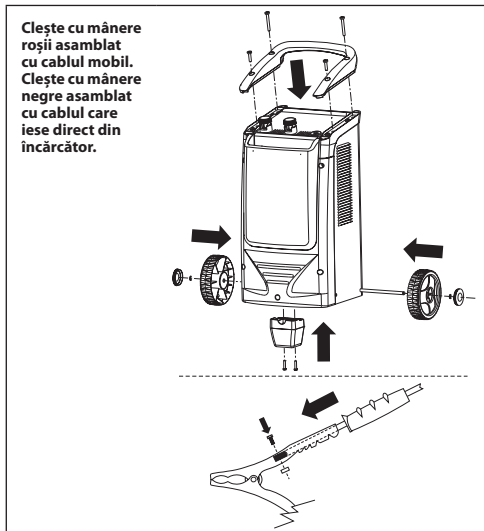

Clește cu mână roșii asamblat cu cablul mobil.
 Clește cu mână negre asamblat cu cablul care iese direct din încărcător.

3.1 AMPLASAREA ÎNCĂRCĂTORULUI

În timpul funcționării, poziționați încărcătorul în mod stabil și asigurați-vă că nu împiedicați circulația aerului prin deschiderile prevăzute, garantând astfel o ventilație suficientă.

3.2 CONECTAREA LA REȚEAUA ELECTRICĂ

- Încărcătorul trebuie să fie conectat numai la un sistem de alimentare cu conductor de nul legat la pământ.
- Controlați că tensiunea rețelei electrice corespunde tensiunii de funcționare a încărcătorului, specificată pe placa de date.
- Linia de alimentare va trebui dotată cu sisteme de protecție, precum siguranțe fuzibile sau întrerupătoare automate, suficiente pentru a suporta absorbția maximă a aparatului.
- Conectarea la rețeaua electrică trebuie efectuată prin cablul de alimentare special prevăzut.
- Eventualele prelungitoare ale cablului de alimentare trebuie să aibă o secțiune corespunzătoare și, în orice caz, nu mai mică decât cea a

- cablului de alimentare a aparatului.
- Este obligatoriu întotdeauna să legați aparatul la pământ, utilizând conductorul de culoare galben-verde al cablului de alimentare, marcat cu eticheta (⏚), iar celelalte două conductoare trebuie conectate la fază și la nul în rețeaua de alimentare.

4. FUNCȚIONAREA LA ÎNCĂRCARE

NB: înainte de a efectua încărcarea, verificați capacitatea bateriei (Ah), care nu trebuie să fie mai mică de cea indicată pe placa de date a încărcătorului (C min). Executați instrucțiunile urmând strict ordinea de mai jos.

4.1 PREGĂTIREA BATERIEI

Dacă bateria este de tip WET procedați astfel:

- Scoateți capacele bateriei (dacă sunt prezente), astfel încât gazele produse în timpul încărcării să poată ieși. Controlați că nivelul electrolitului acoperă plăcile bateriei; dacă acestea sunt descoperite adăugați apă distilată până la acoperirea lor cu 5 - 10 mm.



ATENȚIE! FIȚI FOARTE ATENȚI ÎN TIMPUL ACESTEI OPERAȚIUNI, DEOARECE ELECTROLITUL ESTE UN ACID DEOSEBIT DE COROZIV.

4.2 CONECTARE ÎNCĂRCĂTOR/BATERIE

- Verificați că ștecherul cablului de alimentare este deconectat de la priza de curent.
 - Pentru modelele cu mai multe tensiuni de încărcare, poziționați deviatorul sau comutatorul în mod corespunzător tensiunii dorite de încărcare. În lipsa deviatorului sau a comutatorului, conectați cablul cu cleștele de încărcare roșu (simbolul +) la borna încărcătorului în mod corespunzător tensiunii dorite de încărcare.
 - Cuplați cleștele marcat cu roșu la borna pozitivă a bateriei (simbolul +). Dacă simbolurile nu se disting, vă reamintim că borna pozitivă este aceea care nu este legată la caroseria mașinii.
 - Cuplați cleștele marcat cu negru la caroseria mașinii, departe de baterie și de conducta carburantului.
- NOTĂ: dacă bateria nu este instalată pe mașină, cuplați direct la borna negativă a bateriei (simbolul -).

4.3 ÎNCĂRCAREA SIMULTANĂ A MAI MULTE BATERII

ATENȚIE: nu încărcați baterii cu capacitate, descărcare și tipologie diferită între ele. Când încărcați mai multe baterii în același timp, puteți recurge la legături în „serie” sau în „paralel”:

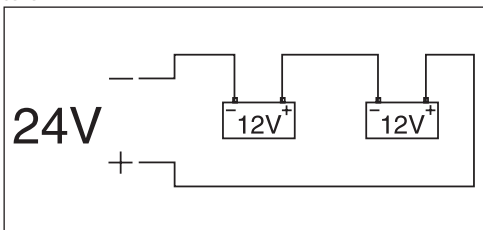

paralel

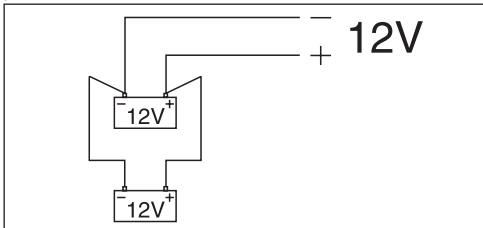

Conectarea în „paralel” prevede ca bateriile să aibă aceeași tensiune nominală (Volt), corespunzătoare celei care iese din încărcător și ca suma Ah să fie cuprinsă în intervalul de încărcare a încărcătorului.

Conectarea în „serie” prevede ca bateriile să aibă aceeași capacitate (Ah) și ca suma tensiunilor nominale ale tuturor bateriilor să fie corespunzătoare celei care iese din încărcător.

4.4 SFÂRȘITUL ÎNCĂRCĂRII

- Întrerupeți alimentarea încărcătorului, scoțând priza cablului de alimentare din priza electrică.
- Decuplați cleștele marcat cu negru de la caroseria vehiculului sau de la borna negativă a bateriei (simbolul -).

- Decuplați cleștele marcat cu roșu de la borna pozitivă a bateriei (simbolul +).
- Depozitați încărcătorul la loc uscat.
- Închideți celelele bateriei cu dopurile prevăzute (dacă sunt prezente).

5. FUNCȚIONAREA LA PORNIRE

ATENȚIE: înainte de acțiune, citiți cu atenție recomandările fabricanților acestor vehicule!

- Asigurați-vă că ați protejat linia de alimentare cu siguranțe fuzibile sau cu întrerupătoare automate cu valoarea corespunzătoare indicată pe placa de date cu simbolul ().
- Pentru a facilita pornirea, efectuați în prealabil o încărcare rapidă de 10-15 minute, cu încărcătorul în poziția de încărcare și NU de pornire.
- Dacă vehiculul nu pornește așteptați câteva minute și repetați operația de încărcare rapidă. Nu insistați dacă motorul vehiculului nu pornește: în acest fel s-ar putea compromite în mod serios bateria sau chiar echipamentul electric al vehiculului.

5.1 CONECTARE ÎNCĂRCĂTOR/BATERIE

- Înainte de a proceda la pornirea vehiculului, asigurați-vă că valoarea tensiunii nominale a bateriei corespunde valorii setate în încărcător.
- Asigurați-vă că bateria este cuplată bine la bornele respective (+ și -), conexiunile la baterie sunt corecte și bateria este în stare bună (nu este sulfată și nu este defectă).
- Nu efectuați în niciun caz porniri ale vehiculelor cu baterii decuplate de la bornele respective; prezența bateriei este determinantă pentru eliminarea eventualelor supratensiuni ca efect al energiei care s-ar putea acumula în cablurile de legătură în timpul fazelor de pornire. **Nerespectarea acestor dispoziții poate deteriora partea electronică a vehiculului.**

5.2 PORNIREA

- Pentru selectarea acestei funcții, a se vedea ilustrația „PORNIREA”.

5.3 SFÂRȘITUL PORNIRII

- Scoateți ștecherul cablului de alimentare al încărcătorului din priza electrică.
- Decuplați cleștele de încărcare de culoare neagră de la borna negativă a bateriei (simbolul -) și cel de culoare roșie de la borna pozitivă a bateriei (simbolul +).
- Depozitați încărcătorul la loc uscat.

6. PROTECȚIILE ÎNCĂRCĂTORULUI

Încărcătorul de baterii se autoprotejează în caz de:

- Suprasarcină (debitare excesivă de curent la baterie).
- Scurtcircuit (clești de încărcare puși în contact unul cu altul).
- Inversarea polarității la bornele bateriei.

La aparatele prevăzute cu siguranțe fuzibile este obligatoriu, în cazul înlocuirii, să folosiți piese de schimb asemănătoare, având aceeași valoare de curent nominal.



ATENȚIE: Încuirea siguranței fuzibile cu valori ale curentului diferite de cele indicate pe plăcuța de identificare ar putea provoca daune persoanelor sau lucrurilor. Din același motiv, evitați cu desăvârșire înlocuirea siguranței așchii cu fire de cupru sau alt material. Operația de înlocuire a siguranței fuzibile trebuie efectuată întotdeauna cu cablul de alimentare DECONECTAT de la rețea. Fiți atenți în timpul înlocuirii siguranței fuzibile lamelare, când este prezentă, strângeți bine șuruburile de fixare.

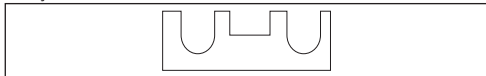

7. SFATURILE UTILE

- Curățați borna pozitivă și cea negativă de încrustații posibile de oxid pentru a asigura un contact bun al cleștilor.
- Dacă bateria la care se dorește folosirea acestui încărcător este instalată în permanență pe un vehicul, consultați și manualul de instrucțiuni și/sau de întreținere a vehiculului la capitolul „INSTALAȚIA ELECTRICĂ” sau „ÎNȚEȚINEREA”.



VIKTIGT: LÄS BRUKSANVISNINGEN NOGGRANNT INNAN NI ANVÄNDER BATTERILADDAREN.

1. ALLMÄNNA SÄKERHETSANVISNINGAR



- Undvik kontakt med batteriets syra. Vid stänk eller om du kommer i kontakt med syran, skölj omedelbart den gällande delen med rent vatten. Fortsätt att skölja tills läkaren anländer.



- Under laddningen avger batterierna explosiva gaser. Förhindra att lågor och gnistor bildas. RÖK EJ.
- Placera de batterier som ska laddas på en väl ventilerad plats.



- Skydda ögonen. Ha alltid på dig skyddsglasögon då du arbetar med batterier som innehåller blysyra.



- Klä dig på lämpligt vis. Använd inte löst sittande kläder eller smycken som kan fastna i de rörliga delarna. Under arbetet, rekommenderar vi dig att använda skyddskläder med elektrisk isolering samt skor med halksula. Om du har långt hår, ska du ha på dig en skyddsmössa.



- Vid brist av kunskap ska personer instrueras innan apparaten används.
- Apparaten får lov att användas av barn över 8 år och av personer med nedsatt fysisk, sensorisk eller mental förmåga, eller med bristande erfarenhet och kunskap förutsatt att de får tillsyn eller har fått instruktioner om hur apparaten ska användas på ett säkert sätt och förstår vilka risker det innebär.
- Barn får inte leka med apparaten.
- Rengöringen och underhållet som tillkommer användaren får inte utföras av barn utan tillsyn.
- Använd batteriladdaren uteslutande inomhus och försäkra er om att ventilationen är god: UTSÄTT INTE LADDAREN FÖR REGN ELLER SNÖ.
- Drag alltid först ut stickkontakten ur eluttaget innan laddningskablarna ansluts till eller lossas från batteriet.
- Anslut eller fränkoppla inte batteriladdarens tänger till eller från batteriet när batteriladdaren är i funktion.
- Använd absolut inte batteriladdaren inuti ett fordon eller i motorutrymmet.
- Byt endast ut matningskabeln mot en originalkabel.
- Om elkabeln är skadad ska den bytas ut av tillverkaren eller av tillverkarens tekniska servicecenter, eller av en person som har likvärdig behörighet, för att förhindra eventuella risker.
- Använd inte batteriladdaren för att ladda ej laddningsbara batterier.
- Kontrollera att den tillgängliga matningsspänningen motsvarar den som indikeras på skylten på batteriladdaren.
- För att inte skada fordonens elektronik, ska du noga följa varningarna från tillverkaren av fordonet eller batterierna som används.
- Denna batteriladdare innehåller delar som strömbrytare och reläer, som kan framkalla ljusbågar eller gnistor. Om laddaren används på en bilverkstad eller liknande bör den således placeras på en säker och för ändamålet lämplig plats.
- Reparations- eller underhållsgrepp inne i batteriladdaren får endast utföras av kunnig personal.
- **VARNING: DRAG ALLTID UT KONTAKTEN UR ELUTTAGET INNAN NI UTFÖR NÅGOT INGREPP FÖR KONTROLL ELLER UNDERHÅLL AV BATTERILADDAREN, FARA!**
- Batteriladdaren skyddas mot indirekta kontakter via en jordningsledning som föreskrivs för apparater av klass I.

Kontrollera att eluttaget är utrustat med en jordanslutning.

- Anslut kontakter som har lämplig kapacitet, inte lägre än det värde för säkringen som anges på märkplåten på de modeller som inte har kontakter.



- Apparatur av klass A:
Den här batteriladdaren uppfyller kraven i den tekniska produktstandarden för användning i industrimiljö och för professionellt bruk. Vi garanterar inte att produkten överensstämmer med kraven för elektromagnetisk kompatibilitet i bostadshus och i byggnader som har direkt anslutning till lågspanningsnät som försörjer hushållen.

2. ALLMÄN BESKRIVNING

Batteriladdare som är avsedd för laddning av blybatterier WET, EFB, GEL, AGM + (Ca) och litiumbatterier Li som används på motorfordon (bensin och diesel) och elfordon: bilar, motorfordon, motorcyklar, båtar etc. Batterier på 12V, 24V kan laddas. Det förutses även ett startläge (endast för fordon med bensin- eller dieselmotor).

Laddningsbara ackumulatörer baserat på tillgänglig utspänning: 12V / 6 celler, 24V / 12 celler.

3. INSTALLATION

UPPSTÄLLNING

- Packa upp batteriladdaren och montera ihop de olika komponenterna som förpackningen innehåller.
- Hjulförsedda modeller ska installeras i vertikalt läge.

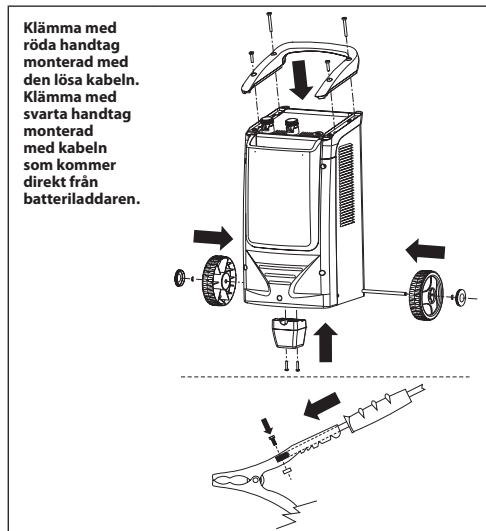

3.1 BATTERILADDARENS PLACERING

När batteriladdaren är i funktion ska den vara stadigt placerad. Se till att inre luftväxlingen genom de särskilda öppningarna hindras så att tillräcklig ventilation garanteras.

3.2 ANSLUTNING TILL ELNÄTET

- Batteriladdaren får endast anslutas till ett kraftsystem med neutralledaren ansluten till jord.
- Kontrollera att nätspänningen överensstämmer med batteriladdarens driftspänning, som är angiven på märkplåten.
- Matningslinjen ska vara försedd med skyddssystem, som säkringar eller automatsäkringar, som är tillräckliga för att tåla apparatens maximala strömförbrukning.
- Anslutningen till elnätet ska utföras med särskild nätkabel.
- Eventuella förlängningskabler till nätkabeln måste ha en lämplig diameter och den får aldrig vara under diametern för nätkabeln till apparaten.
- Det är alltid obligatoriskt att ansluta enheten till jord med hjälp av nätkabelns gul-gröna ledning, enligt märkningen på etiketten (⏚), medan de andra båda ledningarna ska anslutas till fasledaren och till neutralledaren på eldistributionsnätet.

4. FUNKTION UNDER LADDNING

Obs! Innan batteriet laddas, kontrollera att det batteri som ska laddas inte har en kapacitet (Ah) som är lägre än den som anges på batteriladdarens märkplåt (Cmin). Utför instruktionerna genom att noga följa ordningen nedan.

4.1 FÖRBEDRELSE AV BATTERIET

Om det batteri som ska laddas är av typ WET, gör så här:

- Ta bort propparna på batteriet (i förekommande fall) så att gasen som genereras under laddningen kan komma ut. Kontrollera att elektrolytvätskenivån täcker batteriplattorna; om de inte är täckta, ska du tillsätta destillerat vatten tills de är täckta med 5 - 10 mm.



OBST! VAR MAXIMALT FÖRSIKTIG UNDER DENNA ÅTGÄRD EFTERSOM ELEKTROLYTVÄTSKAN ÄR EN MYCKET FRÄTANDE SYRA.

4.2 ANSLUTNING AV BATTERILADDAREN/BATTERIET

- Kontrollera att matningskabeln är bortkopplad från elnätet.
- För modeller med flera laddningsspänningar ska avledaren eller omkopplaren placeras i höjd med vald laddningsspänning. Om ingen avledare eller omkopplare finns ska man ansluta kabeln med röd laddningsklämma (symbol +) till den avsedda polen på batteriladdaren i höjd med vald matningsspänning.
- Anslut den röda laddningsklämman till batteriets pluspol (symbol +). Om symbolerna inte kan läsas, kom ihåg att pluspolen är den som inte är ansluten till fordonets chassi.
- Anslut den svarta laddningsklämman till fordonschassit, på avstånd från batteriet och bränsleledningen.
OBST! Om batteriet inte är installerat på fordonet, utför direktanslutning till batteriets minuspol (symbol -).

4.3 LADDA FLERA BATTERIER SAMTIDIGT

VARNING: ladda inte batterier med olika kapacitet, urladdning och typ. Då du behöver ladda flera batterier samtidigt kan du använda seriekoppling eller parallell koppling:

serie

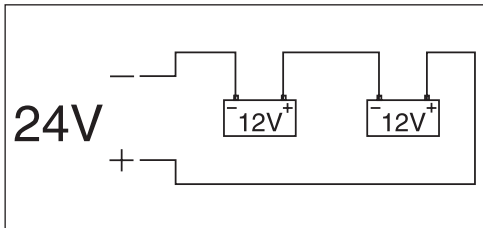

parallell

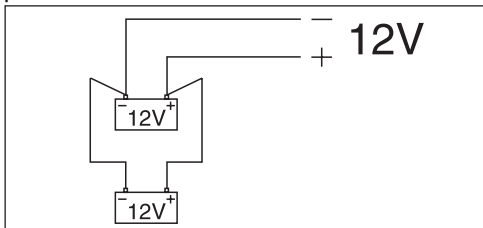

Parallell koppling kräver att batterierna har samma märkström (Volt) som överensstämmer med batteriladdarens utgångsström och att summan av Ah är inom batteriladdarens laddningsomfång.

Seriekoppling kräver att batterierna har samma kapacitet (Ah) och att summan av de nominella spänningarna hos alla batterier överensstämmer med batteriladdarens utgångsström.

4.4 SLUT PÅ LADDNINGEN

- Koppla från strömtillförseln till batteriladdaren genom att dra ut nätkabelns stickkontakt från väggkontakten.
- Koppla från den svarta laddningsklämman från fordonets chassi eller från batteriets minuspol (symbol -).
- Koppla från den röda laddningsklämman från batteriets pluspol (symbol +).
- Förvara batteriladdaren på en torr plats.
- Stäng battericellerna med de särskilda propparna (i förekommande fall).

5. FUNKTION VID START

VARNING: innan du sätter igång, läs noggrant varningarna från fordonstillverkaren!

- Se till att skydda matningslinjen med säkringar eller automatbrytare vars värde överensstämmer med vad som anges på skylten med symbolen ().
- För att underlätta starten, utför först en snabbbländning på 10-15 minuter, med batteriladdaren i laddningsläge och EJ i startläge.
- Om fordonet inte startar, vänta några minuter och upprepa snabbbländningen. Insistera inte ytterligare om fordonets motor inte startar. Allvarliga skador kan uppstå på batteriet och till och med på fordonets elutrustning.

5.1 ANSLUTNING AV BATTERILADDAREN/BATTERIET

- Innan du startar fordonet ska du kontrollera att batteriets nominella spänningsvärde motsvarar det värde som är inställt i batteriladdaren.
- Se till att batteriet är korrekt anslutet till respektive poler (+ och -), att anslutningarna till batteriet är korrekt utförda och att batteriet är i gott skick (inte sulfaterat och inte trasigt).
- Starta aldrig fordon med batterierna frånkopplade från respektive poler. Batteriets förekomst är avgörande för att eliminera eventuell överspänning på grund av den energi som kan samlas in anslutningskabla under startfaserna. **Om dessa föreskrifter inte iakttas kan detta skada fordonets elektroniska utrustning.**

5.2 START

- För att välja denna funktion, se bilden "START".

5.3 EFTER STARTEN

- Ta ut nätkabelns stickpropp från elnätets uttag.
- Koppla bort den svarta laddningsklämman från batteriets minuspol (symbol -) och den röda laddningsklämman från batteriets pluspol (symbol +).
- Förvara batteriladdaren på torr plats.

6. SKYDD AV BATTERILADDAREN

Batteriladdaren skyddas automatiskt vid:

- Överbelastning (för mycket ström som avges till batteriet).
- Kortslutning (laddningsklämmor i kontakt med varandra).
- Polaritetsväxling av batteriets poler.

På apparater försedda med säkringar är det (vid byte) obligatoriskt att använda likvärdiga reservdelar med samma nominella strömvärde.



OBSERVERA! Om säkringen byts ut mot en med andra strömvärden än vad som anges på märkskylten kan det leda till skada på personer eller föremål. Av samma skäl, byt aldrig ut säkringen mot bryggor av koppar eller dylikt. Byte av säkring ska alltid göras med stickkontakten BORTTAGEN från elnätet. Byte av lamellisäkringen (i förekommande fall) ska utföras försiktigt och läsmuttrarna ska dras åt ordentligt.

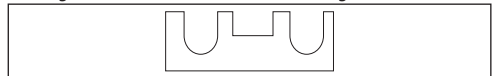

7. ANVÄNDBARA RÅD

- Rengör de positiva och negativa polerna från eventuella oxidavlagringar för att garantera god kontakt med startklämmorna.
- Om batteriet som denna batteriladdare ska användas på är permanent insatt i fordonet, se även bruksanvisningen och/eller fordonets underhållsmanual under "ELEKTRISK INSTALLATION" eller "UNDERHÅLL".



GIV AGT: LÆS BRUGERVEJLEDNINGEN OMHYGGELIGT IGENNEM, FØR BATTERILADEN TAGES I BRUG.

1. ALMENE SIKKERHEDSREGLER FOR ANVENDELSE



- Undgå kontakt med syren i batteriet. Hvis man rammes af syresprøjt ud eller hvis den kommer i kontakt med øjnene, skal man straks skylle den ramte del med rent vand. Bliv ved med at skylle med vand indtil lægens ankomst.



- Under opladningen dannes der eksplosive gasser. Eliminér risici for flamme og gnistdannelse. RYG IKKE!
- Placér batterierne på et sted med god udluftning, mens de oplades.



- Beskyt øjnene. Der skal altid anvendes beskyttelsesbriller, når der arbejdes med batterier med surt bly.



- Bær egnet tøj. Undlad at tage vidde klæder eller smykker på, der vil kunne sætte sig fast i bevægelige dele. Det er vigtigt at anvende elektrisk isolerede beskyttelsesklæder og skridsikert fodtøj under arbejdet. Langt hår skal tildækkes med en beskyttelseshætte.



- Uerfarne personer skal oplæres på passende vis, før de tager apparatet i brug.
- Apparatet kan anvendes af børn på mindst 8 år og personer med nedsatte fysiske, sansemæssige eller åndelige evner samt af personer, der ikke råder over den fornødne erfaring eller viden, såfremt de holdes under opsyn eller er blevet sat ind i, hvordan apparatet anvendes på sikker vis og har forstået de dermed forbundne farer.
- Børn må ikke lege med apparatet.
- Rengørings- og vedligeholdelsesopgaver, der påhviler brugeren, må ikke foretages af børn uden opsyn.
- Anvend udelukkende batteriladeren indendørs på steder med tilstrækkelig ventilation: UDSÆT IKKE OPLADEREN FOR REGN OG SNE!
- Træk altid først stikket ud af stikkontakten, før ladekablerne sluttes til eller tages af batteriet.
- Batteriladen må ikke være i funktion, mens tængerne sluttes til eller tages af batteriet.
- Anvend aldrig batteriladeren inde i et køretøj eller i motorhjelmen.
- Forsyningsledningen må udelukkende udskiftes med et originalt.
- Hvis forsyningsledningen er beskadiget, skal den udskiftes af producenten eller af den tekniske assistance eller under alle omstændigheder af en person med tilsvarende kompetence for at undgå hvilken som helst risiko.
- Batteriladeren må ikke anvendes til opladning af batterier, der ikke kan genoplades.
- Kontrollér om netspændingen, som er til rådighed, stemmer overens med angivelserne på batteriladerens typeskilt.
- For ikke at beskadige køretøjernes elektronik skal man nøje overholde anvisningerne fra køretøjernes eller de anvendte batteriers producenter.
- Denne batterilader indeholder dele såsom strømafbrydere og relæer, som kan fremkalde lysbuer og gnister. Hvis batteriladeren anvendes på et bilværksted eller lignende, bør den således placeres på et sikkert sted eller opbevares i egnet indpakning.
- Reparations- og vedligeholdelsesarbejde på batteriladeren må kun udføres af erfarne fagmænd.
- GIV AGT: MAN SKAL ALTID TRÆKKE STIKKET UD AF

STIKKONTAKTEN, FØR DER FORETAGES ENHVER FORM FOR ENKEL VEDLIGEHOLDELSE PÅ BATTERILADEREN, FARE!

- Batteriladeren er beskyttet mod indirekte kontakter med en jordledning ifølge kravene til apparater i klasse I. Kontrollér om stikkontakten er forsynet med jordforbindelse.
- På de modeller, der ikke er forsynet dermed, skal der tilsluttes stik med en passende kapacitet, dvs. ikke mindre end sikringens værdi, der er angivet på typeskiltet.



- Apparat af klasse A:

Denne batterilader opfylder den tekniske standards krav til produkter, der udelukkende anvendes i industrielle omgivelser og til professionel brug. Dens elektromagnetiske kompatibilitet garanteres ikke i bygninger, der er direkte forbundet med et lavspændingsnet, der forsyner husholdninger.

2. ALMEN BESKRIVELSE

Batterilader beregnet til opladning af WET-, GEL-, EFB-, GEL-, AGM + (Ca) og litium-batterier Li, der bruges på motorkøretøjer (benzin og diesel) samt elkøretøjer: biler, motorkøretøjer, motorcykler, både, osv. Det er muligt at genoplade 12V- og 24V-batterier; der findes ligeledes en starttilstand (gælder kun for benzin- og dieselmotorer).

Opladende batterier afhængigt af den tilgængelige udgangsspænding: 12V/6 celler; 24V/12 celler.

3. INSTALLATION

OPSTILLING

- Pak batteriladeren ud, saml de løse dele, der følger med i pakningen.
- Modeller, der er forsynet med vogn, skal stilles op i lodret position.

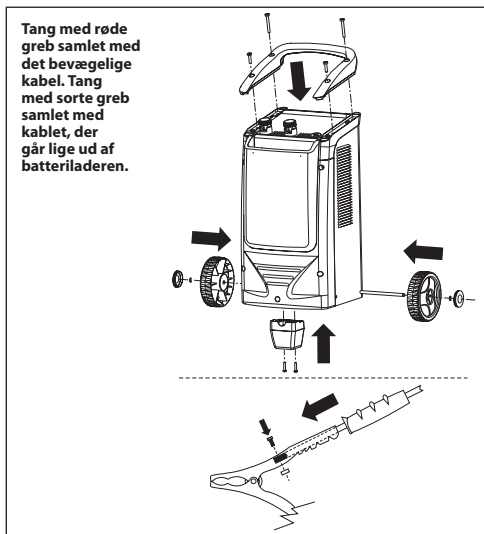

3.1 PLACERING AF BATTERILADEREN

Batteriladeren skal stå på en fast, stabil flade, mens den er i funktion, og man skal sørge for, at luften kan strømme frit gennem de dertil beregnede åbninger, så der sikres tilstrækkelig ventilation.

3.2 FORBINDELSE TIL ELFORSYNINGEN

- Batteriladeren må udelukkende forbindes til et forsyningsystem med en jordforbundet nulledning.
- Kontrollér, om elforsyningsnettets spænding svarer til batteriladerens driftsspænding, der er opført på typeskiltet.
- Forsyningslinjen skal være forsynet med beskyttelsessystemer, såsom sikringer eller automatiske afbrydere, der kan holde til apparatets maksimale forbrug.
- Forbindelsen til elforsyningsnettet skal oprettes ved hjælp af det dertil beregnede forsyningskabel.
- Eventuelle forlængerledninger skal have et passende tværsnit, under ingen omstændigheder mindre end apparatets forsyningskabels.
- Det er under alle omstændigheder obligatorisk at tilslutte apparatet til jordforbindelsen ved hjælp af forsyningskablets gul-grønne leder, der er forsynet med etiketten (⏚), mens de andre to ledere skal forbindes

til elforsyningsnettets fase og nul.

forefindes).

4. FUNKTION UNDER OPLADNING

OBS: Før man går i gang med opladningen, skal man kontrollere, om kapaciteten for det batteri (Ah), der skal oplades, ikke er mindre end den, der er angivet på batteriladerens typeskilt (Cmin). Anvisningerne skal følges helt nøjagtigt i den rækkefølge, de er opført i nedenfor.

4.1 KLARGØRING AF BATTERIET

Hvis det batteri, der skal oplades, er af typen WET, følges denne fremgangsmåde:

- Fjern batteriets hætter (såfremt de forefindes), så gassen, der opstår under opladningen, kan strømme ud. Kontrollér, at elektrolyttens niveau dækker batteripladerne; hvis de ikke er tildækket, hældes der destilleret vand på, indtil pladerne er 5-10 mm under vandet.



GIV AGT! UDVIS STØRST MULIG FORSIGTIGHED UNDER DETTE ARBEJDE, DA ELEKTROLYTTEN ER EN YDERST ÆTSENDE SYRE.

4.2 FORBINDELSE AF BATTERILADER/BATTERI

- Kontrollér, om forsyningskablet er frakoblet netstikkontakt.
 - På modeller med flere spændingsværdier skal omskifteren stilles ud for den ønskede ladespænding. Hvis omskifteren ikke forefindes, skal kablet med den røde ladetang (symbolet +) forbindes korrekt til den dertil beregnede klemme på batteriladeren ud for den valgte ladespænding.
 - Forbind den røde ladetang med batteriets plusklemme (symbolet +). Hvis symbolerne ikke er tydelige, skal man huske på, at plusklemmen er den, der ikke er forbundet til køretøjets chassis.
 - Forbind den sorte ladetang med bilens chassis, langt væk fra batteriet og brændstoftørrer.
- BEMÆRKNING:** Hvis batteriet ikke er monteret i bilen, oprettes der en direkte forbindelse med batteriets minusklemme (symbol -).

4.3 SAMTIDIG OPLADNING AF FLERE BATTERIER

GIV AGT: Der må ikke oplades batterier med forskellig kapacitet og afladnings tilstand eller af forskellig type. De batterier, der skal oplades samtidigt, kan enten serie- eller parallelforbindes: serieforbindelse

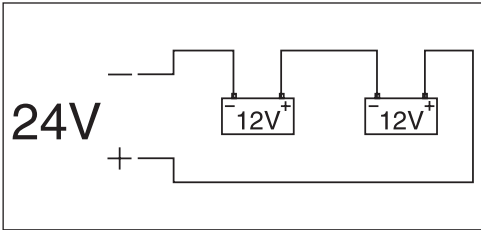

parallelforbindelse

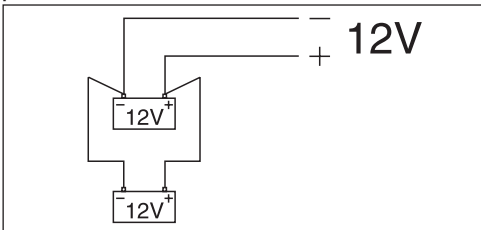

“Parallel” forbindelse kræver, at batterierne har den samme nominelle spænding (Volt), svarende til batteriladerens udgangsspænding, samt at summen af Ah befinder sig indenfor batteriladerens opladningsområde. “Serieforbindelse” kræver, at batterierne har den samme kapacitet (Ah), samt at summen af alle batterierne nominelle spænding svarer til batteriladerens udgangsspænding.

4.4 AFSLUTNING AF OPLADNING

- Afbryd netforsyningen til batteriladeren ved at adskille forsyningskablets stik fra elforsyningsnetstikkontakt.
- Kobl den sorte ladetang fra køretøjets chassis eller batteriets minusklemme (symbol -).
- Kobl den røde ladetang fra batteriets plusklemme (symbol +).
- Placér batteriladeren på et tørt sted.
- Luk batteriets celler til igen med de dertil beregnede hætter (hvis de

5. FUNKTION VED START

GIV AGT: Før arbejdet påbegyndes, skal man sætte sig nøje ind i anvisningerne fra køretøjsfabrikanten!

- Sørg for at beskytte forsyningslinjen med sikringer eller automatiske afbrydere, der overholder værdierne angivet med symbolet () på typeskiltet.
- For at lette starten skal der først foretages en hurtig opladning på 10-15 minutter med batteriladeren i ladestilling, IKKE i startstilling.
- Hvis køretøjet ikke går i gang, vent et par minutter, og gentag så den hurtige opladning. Insister ikke, hvis køretøjets motor ikke går i gang; der opstår nemlig ellers fare for alvorlige skader på batteriet eller i værste fald på køretøjets elektriske udstyr.

5.1 FORBINDELSE AF BATTERILADER/BATTERI

- Før man går i gang med start af køretøjet, skal man kontrollere, om batteriets nominelle spænding stemmer overens med den værdi, der er indstillet i batteriladeren.
- Kontrollér, om batteriet er rigtigt forbundet til de tilhørende klemmer (+ og -), at forbindelserne i batteriets retning er korrekte, samt at det er i god forfatning (hverken sulfateret eller i stykker).
- Køretøjet må under ingen omstændigheder startes, hvis batterierne er frakoblet de tilhørende klemmer; batteriet er strengt nødvendigt for at bortskaffe eventuelt overspænding, der vil kunne dannes pga. eventuel ophobning af energi i forbindelseskablerne under startfasen. **Tilsidesættelse af disse forskrifter kan medføre skader på køretøjets elektronik.**

5.2 START

- Hvad angår valg af denne funktion, se billedet “START”.

5.3 AFSLUTNING AF START

- Adskil forsyningskablets stik fra netforsyningsnetstikkontakt.
- Adskil den sorte ladetang fra batteriets minusklemme (symbol -) og den røde fra batteriets plusklemme (symbol +).
- Placér batteriladeren på et tørt sted.

6. BATTERILADERENS BESKYTTELSSEFUNKTIONER

Batteriladeren beskytter sig selv i følgende tilfælde:

- Overbelastning (for stor strømtilførsel mod batteriet).
- Kortslutning (ladetænger placeret i kontakt med hinanden).
- Ombytning af batteriets klemmers poler.

På apparater, der er forsynet med sikringer, er der pligt til at anvende tilsvarende, originale reservedele med den samme nominelle strømværdi.



GIV AGT: Hvis sikringen erstattes med en, der har en anden, nominal strømværdi end den, der er angivet på specifikationsmærkaten, kan der forvoldes skader på personer eller materielle goder. Af samme årsag må man under ingen omstændigheder erstatte sikringer med broer af kobber eller andet materiale. Før udskiftningen af sikringen skal forsyningsledningen FRAKOBLES netforsyningen. I forbindelse med udskiftning af båndsikringer skal man sørge for at stramme de eventuelle låsemøtrikker godt.



7. NYTTIGE RÅD

- Rens plus- og minusklemmen for oxidaflejringer, så der sikres en god kontakt mellem tængerne.
- Hvis det batteri, der skal oplades med denne batterilader, er fast installeret på et køretøj, er man nødt til også at læse køretøjets brugs- og/eller vedligeholdelsesvejledning, især afsnittet “ELANLÆG” eller “VEDLIGEHOLDELSE”.



ADVARSEL: FØR DU BRUKER BATTERILADEREN SKAL DU LESE HÅNDBOKA NØYE!

1. GENERELLE FORHOLDSREGLER FOR BRUK



- Unngå kontakt med batteriets syra. Ved sprøyt eller kontakt med syren ska du umiddelbart skylle den gjeldende delen med rent vann. Fortsett å skylle til legen kommer.



- Under batteriladningen dannes det eksplosive gasser. Unngå farer som flammer og gnistdannelse. IKKE RØYKI!
- Plasser batteriene på en plass med god ventilasjon for ladningsprosedyrene.



- Beskytt øyne dine. Bruk alltid vernebriller når du arbeider med batterier som inneholder blysyra.



- Kle deg på egnet måte. Bruk ikke vide klær eller smykker som kan fastne i de bevegelige delene. Under arbeidet anbefaler vi deg å bruke verneklær med elektrisk isolering og verneskor for et godt grep på underlaget. Hvis du har langt hår, skal du ha på deg vernehøse.



- Personer uten erfaringer må instrueres før de bruker apparatet.
- Apparatet kan brukes av barn over 8 år og personer med reduserte fysiske, følelsesmessige eller mentale evner, eller som mangler erfaring og kunnskap, så lenge de er under oppsyn eller har blitt instruert i sikker bruk av apparatet og forstår farene det innebærer.
- Barn må ikke leke med apparatet.
- Barn må ikke foreta rengjørings- eller vedlikeholdsp oppgaver uten å være under oppsyn.
- Bruk kun batteriladeren innendørs og med god ventilasjon: LADEREN MÅ IKKE UTSETTES FOR REGN ELLER SNØ!
- Støpslet må alltid tas ut av kontakten for nettilkoplingen før du kopler ladekablene fra eller til batteriet.
- Du skal aldri kople eller frakople tengene til batteriet med batteriladeren igang.
- Batteriladeren må absolutt ikke brukes inne i en bil eller i bagasjerommet.
- Strømtilførselskabelen må kun skiftes ut med en originalkabel.
- Hvis strømledningen er ødelagt, må denne skiftes ut av produsenten eller produsentens servicetjeneste eller uansett av en person med lignende kvalifikasjoner, for slik at all risiko kan unngås.
- Batteriladeren må ikke brukes til batterier som ikke er oppladbare.
- Kontroller at tilgjengelig strømspenning tilsvarer verdiet som er indikert på batteriladerens skilt da du bruker batteriladeren for ladning og oppstart; dette gjelder også for indikasjonene som batterifabrikanten forsyner.
- For å ikke skade kjøretøyet elektronikk, skal du nøye følge advarslene fra fabrikanten av kjøretøyet eller batteriene som er brukt.
- Denne batteriladeren inneholder deler som strømbryter og rele som kan lage lysbuer eller gnister. Når laderen brukes på et bilverksted eller lignende, bør den plasseres på et sikkert og hensiktsmessig sted.
- Reparasjons- og vedlikeholdsarbeid må batteriladeren må kun utføres av fagpersonell.
- **ADVARSEL! KONTROLLER ALLTID AT NETTKABELEN IKKE ER TILKOPIET STRØMNETTET VED KONTROLL OG VEDLIKEHOLD AV BATTERILADEREN! FARE!**

- Batteriladeren beskyttes mot indirekte kontakter ved hjelp av en jordeledning som er foreskrevet for apparater av klasse I. Kontroller at uttaket er utstyrt med jordeledningsvern.
- Ved modellene hvor dette mangler, må man koble til en kontakt med tilstrekkelig og ikke lavere verdi enn sikringen indikert på ID-skiltet.



- Klasse A apparater:

Denne batteriladeren oppfyller de standard tekniske produktkravene for bruk i industrielle miljøer og til profesjonell bruk. Samsvart med elektromagnetisk kompatibilitet i bolighus og i hus direkte koblet til et lavspenning strømmnett som forsyner strøm til bolighus garanteres ikke.

2. GENERELL BESKRIVELSE

Batterilader indikert for ladning av blybatterier WET, EFB, GEL, AGM + (Ca) og litiumbatterier benyttet i motorkjøretøyer (bensin eller diesel) og elektriske kjøretøyer: biler, motorkjøretøyer, motorsykler, båter etc. Det er mulig å lade batterier på 12V, 24V; modaliteten starthjelp også forutsatt (kun for bensin og dieselmotorer).

Oppladbare akkumulatører basert på tilgjengelig uttakspenning: 12V / 6 celler; 24V / 12 celler.

3. INSTALLASJON

UTRUSTNING

- Pakk ut generatoren, monter de avtatte delene som følger med i emballasjen.
- Modellene med tralle må installeres i vertikal posisjon.

Klemme med røde håndtak monteret med mobil ledning. Klemme med svarte håndtak monteret med ledningen som går direkte ut fra batteriladeren.

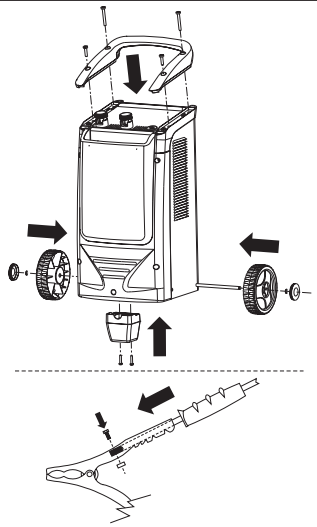

3.1 Plassering av BATTERILADEREN

Plasser batteriladeren på en stabil måte ved bruk og forsikre seg om å ikke hindre at luft passerer gjennom de egnede åpningene, for slik å garantere tilstrekkelig ventilasjon.

3.2 KOBLING TIL STRØMNETT

- Batteriladeren må bare kobles til et strømsystem med nøytral leder koblet til jord.
- Kontroller at spenningen ved strømmettet tilsvarer batteriladerens driftspenning, som gjengis på ID-skiltet.
- Forsyningslinjen må være utstyrt med sikringsystemer, enten sikringer eller automatiske brytere, som tåler apparatets maksimale absorpsjon.
- Kobligen til strømmettet må skje med egnet strømlledning.
- Eventuelle skjøteledninger ved strømlledningen må ha en tilstrekkelig seksjon og må uansett aldri være mindre enn apparatets strømlledning.
- Det er alltid obligatorisk å jorde apparatet, ved å bruke kontakten av gul-grønn farge på strømlledningen, som er merket med etiketten (↓), mens alle andre kontakter må kobles til fase og til nøytralen ved strømmettet.

4. FUNKSJON VED LADING

NB: Før man utfører ladingen, må man kontrollere at kapasiteten ved batteriet (Ah) som man vil lade ikke er mindre enn den som indikeres på ID-skiltet ved batteriladeren (Cmin). Utfør instruksjonene nøye ifølge ordren nedenfor.

4.1 FORBEREDELSE BATTERI

Hvis batteriet som skal lades er av typen WET, må man gå frem på følgende måte:

- Ta av dekslene på batteriet (hvis det finnes), slik at gassene som produseres under ladingen kan komme ut. - Kontroller at elektrolytnivået dekker batteriplatene; hvis de ikke er dekt skal du tilsette vann til de er dekt til 5 - 10 mm.



ADVARSEL! UTVIS EKSTREM FORSIKTIGHET UNDER DENNE OPERASJONEN DA ELEKTROLYTTBUFFERREAGENS ER EN STERKT ETSENDE SYRE.

4.2 KOPLING BATTERILADER/BATTERI

- Kontroller at kontakten ved strømledningen er koblet fra strømmettet.
- For modellene med flere ladepenninger, må du plassere grensebryteren eller strømvenderen i samsvar med forhåndsvalgt ladepennning. Hvis det ikke finnes en grensebryter eller strømvender, må du koble ledningen med den røde klemmen (symbol +) til den spesifikke terminalen ved batteriladeren i samsvar med forhåndsvalgt ladepennning.

- Koble den røde ladeklemmen til batteriets positive pol (symbol +). Dersom symbolene ikke er preget, vær oppmerksom på at den positive terminalen ikke er koblet til maskinrammen.

- Koble den svarte ladeklemmen til maskinens ramme, på avstand fra batteriet og drivstoffkanalen.

MERK: hvis batteriet ikke er installert i kjøretøyet, må man koble direkte til batteriets negative klemme (symbol -).

4.3 SAMTIDIG LADNING AV FLERE BATTERIER

ADVARSEL: du skal ikke lade batterier som har ulike kapasitet, utladning og type. Hvis du måtte lade flere batterier samtidig kan du bruke koplinger i "serie" eller "parallell":

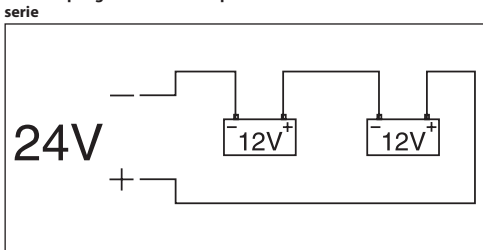

parallell

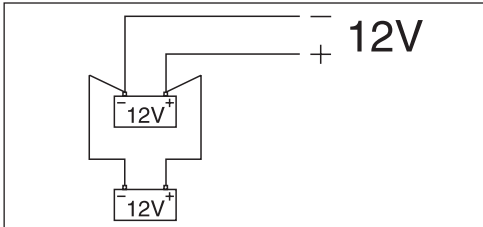

Forbindelsen i "parallell" krever at batteriene har samme nominelle spenning (Volt), tilsvarende det som kommer ut fra laderen, og at summen av Ah er innen batteriladerens ladefelt.

Forbindelsen i "serie" krever at batteriene har samme kapasitet (Ah), og at summen av de nominelle spenninger på alle batterier er tilsvarende den som kommer ut fra laderen.

4.4 SLUTT PÅ LADNINGEN

- Fjern strømmen fra batteriladeren ved å ta ut strømledningen fra strømmuttaket.
- Frakoble den svarte ladningsklemmen fra maskinrammen eller minuspolen på batteriet (symbol -).
- Frakoble den røde ladningsklemmen fra batteriets positive pol (symbol +).
- Plasser laderen på et tørt sted.
- Lukk battericellene ut med pluggen (hvis tilgjengelig).

5. FUNKSJON VED OPPSTART

ADVARSEL: Før du går frem skal du nøye lese advarslene fra bilfabrikanten!

- Forsikre deg om å beskytte matelinjen med sikringer eller automatiske bryter med et verdi som tilsvarer verdien som er indikert på skiltet med symbolet ().
- For å gjøre starten lettere, må man preventivt utføre en hurtiglading på 10-15 minutter med batteriladeren i ladeposisjon og IKKE i startposisjon.
- Hvis motoren ikke starter, vent noen minutter og gjenta hurtigladingen. - Ikke insister videre hvis bilen ikke vil starte: du kan, faktisk, alvorlig påvirke batteriet eller det elektriske utstyret i bilen.

5.1 KOPLING BATTERILADER/BATTERI

- Forsikre seg for man fortsetter med oppstart av kjøretøyet om at den nominale spenningsverdien ved batteriet tilsvarer verdien som er stilt inn ved batteriladeren.
- Sørg for at batteriet er riktig koblet til de respektive terminalene (+ og -) og at kablingene ved batteriet er riktige og at batteriet er i god stand (ikke sulfatert og ikke skadet).
- Man må på ingen måte utføre oppstart av kjøretøy med batteri koblet fra de respektive klemmene; batteriets tilstedeværelse er avgjørende for å fjerne eventuell overspenning på grunn av energi som kan samle seg opp i koblingledningene i løpet av oppstartfasene. **Manglende overholdelse av disse reglene kan føre til skade på kjøretøys elektronikk.**

5.2 OPPSTART

- For å velge denne funksjonen, se illustrasjonen "OPPSTART".

5.3 ENDT OPPSTART

- Ta ut kontakten ved strømledningen fra strømmuttaket.
- Koble den svarte klemmen fra den negative strømpolen ved batteriet (symbol -) og den røde klemmen fra den positive strømpolen ved batteriet (symbol +).
- Plasser laderen på et tørt sted.

6. BATTERILADERENSVERN

Batteriladeren vil beskytte seg selv i tilfelle:

- Overbelastning (for stor ergoasjon av strøm mot batteriet).
- Kortslutning (ladeklemmene kommer i kontakt med hverandre).
- Omstillingen av polene på batteriklemmene.

I apparatene utstyrt med sikringer er det, i tilfelle utskiftning, obligatorisk å bruke reservesikringer med samme nominalstrømverdi.



ADVARSEL: Utskifting av sikring med strømverdier som er forskjellige fra det som indikeres på skiltet kan forårsake skader hos personer eller ting. På grunn av dette må du absolutt unngå å skifte ut sikringen med kobberbroer eller andre materialer. Operasjonen for utskifting av sikringer må alltid utføres med strømledningen KOBLET fra strømmettet. Vær forsiktig under utskifting av trådsikringer hvor disse finnes, og skru godt til festeskruene.



7. NYTTIGE RÅD

- Renjor de positive og negative strømpolene for mulige oksiderte avkalkninger for slik å sikre at klemmene får god kontakt.
- Hvis batteriet hvor man ønsker å bruke denne batteriladeren er festet til kjøretøyet, må man også se kjøretøys håndbok for bruk og/eller vedlikehold, da under kapitlene "ELEKTRISK ANLEGG" eller "VEDLIKEHOLD".



HUOMIO: LUE TÄMÄ KÄYTTÖOHJE HUOLELLISESTI ENNEN AKKULATURIN KÄYTTÄMISTÄ!

1. YLEISET TURVALLISUUSOHJEET KÄYTTÖÄ VARTEN



- Vältä kosketusta akun hapon kanssa. Mikäli happoa roiskuu tai joutuu kosketukseen, huuhtelee heti kyseessä oleva alue puhtaalla vedellä. Jatka huuhtelemista lääkärin saapumiseen asti.



- Latauksen aikana syntyy räjähtäviä kaasuja. Eliminoi liekin ja kipinämuodostusriski. **ÄLÄ POLTA!**
- Aseta ladattavat akut tuuletettuun tilaan.



- Suojaa silmät. Käytä aina suojalaseja työskennellessäsi lyijykauluilla.



- Pukeudu asianmukaisella tavalla. Älä käytä leveitä vaatteita tai koruja, jotka voivat tarttua liikkuviin osiin. Työskentelyn aikana suositellaan pukeutumista sähköisesti eristettyihin suojavaatteisiin sekä liu'unesuojalkineisiin. Mikäli sinulla on pitkät hiukset, käytä ne keräävää päänsuojaa.



- Ammattitaidottomat henkilöt on koulutettava asianmukaisesti ennen laitteen käyttöä.
- Laitteen käyttö on sallittu vähintään 8-vuotiaalle lapsille ja sellaisille henkilöille, joiden fyysinen, aisteihin liittyvä tai henkinen toimintakyky on rajoittunut tai joilla ei ole kokemusta tai tietoa laitteen käytöstä sillä ehdolla, että heitä valvotaan ja opastetaan laitteen turvalliseen käyttöön liittyen ja että he tuntevat sen käyttöön liittyvät vaarat.
- Lapset eivät saa leikkiä laitteella.
- Lapset eivät saa suorittaa säännöllistä puhdistusta ja huoltoa ilman valvontaa.
- Käytä akkulaturia yksinomaan sisätiloissa ja tuuleta tila kunnolla: **ÄLÄ ASETA LATURIA ALTIIKSI SATEELLE JA LUMELLE!**
- Vedä aina pistotulppa pois sähköasiasta ennen kuin liität latauskaapelit akkuun tai poistaa ne siitä.
- Älä kytkä tai irrota pihtejä akkulaturin käydessä.
- Älä koskaan käytä akkulaturia ajoneuvon sisällä tai moottoritalissa.
- Vaihtakaa syöttökaapeli vain alkuperäiseen malliin.
- Anna vahingoittuneen virtajohdon vaihto valmistajan, valtuutetun teknisen huoltopalvelun tai vastaavan ammattipätevyden omaavan henkilön suoritettavaksi, jotta välttyä mahdollisilta onnettomuuksilta.
- Älä käytä akkulaturia kertakäyttöisten akkujen lataamiseen.
- Tarkista, että käytettävän verkon jännite vastaa akkulaturissa olevan kylin tietoja.
- Jotta et vaurioittaisi ajoneuvojen elektroniikkaa, noudata tarkasti käytettävien ajoneuvojen ja akkujen valmistajien ohjeita.
- Tämä akkulaturi sisältää osia, kuten virtakytkin ja rele, jotka voivat aiheuttaa valokaaria ja kipinöitä. Kun laturia käytetään autokorjamoilla tai vastaavassa paikassa, se pitää näin ollen sijoittaa turvallisesti ja käyttötarkoitukseen sopivaan paikkaan.
- Vain pätevä asentaja saa suorittaa akkulaturin korjaus- ja huoltoimenpiteet.
- HUOMIO: KUN TARKASTAT JA HUOLLAT AKKULATURIA, TARKISTA AINA ETTÄ VERKKOJOHTO EI OLE KYTKETTY. VAARA!
- Akkulaturi on suojattu epäsuorilta kosketuksilta maadoitusjohtimella, kuten luokan I laitteille on määrätty. Tarkista, että pistoke on varustettu suojavaadoituksella.
- Liitä malleihin, joissa ei ole sopivanteohisia pistokkeita,

pistokkeet, joiden arvo ei ole alle, vaan tietokyltissä ilmoitetun sulakkeen kokoinen.



- Luokan A laite:

Tämä akkulaturi täyttää sellaisen tuotteen teknisen standardin vaatimukset, joka on tarkoitettu teollisuuteen ja ammattilaiskäyttöön. Sähkömagneettista yhteensopivuutta ei taata asuinrakennuksissa eikä rakennuksissa, jotka on liitetty suoraan matalajännitteiseen kotitalouksille tarkoitettuun sähköverkkoon.

2. YLEISKUVAUS

Moottoriajoneuvoissa (bensini ja diesel) sekä sähköajoneuvoissa käytettyjen WET-, EFB-, GEL-, AGM + (Ca)- ja Li-litiumakkujen lataamiseen tarkoitettu laturi: autot, moottoriajoneuvot, moottoripyörät, veneet jne. Voit ladata akkuja välillä 12V, 24V; käytettävissä on myös käynnistystapa (vain bensiinillä ja diesellillä toimiville moottoriajoneuvoille). Ladattavat akut saatavilla olevan ulostulojännitteen mukaan ovat: 12V / 6 kennoa; 24V / 12 kennoa.

3. ASENNUS

PAKKAUS

- Poista akkulaturi pakkauksesta, kokoa pakkauksessa olevat irt-osat.
- Liikuteltavat mallit on asennettava pystyasentoon.

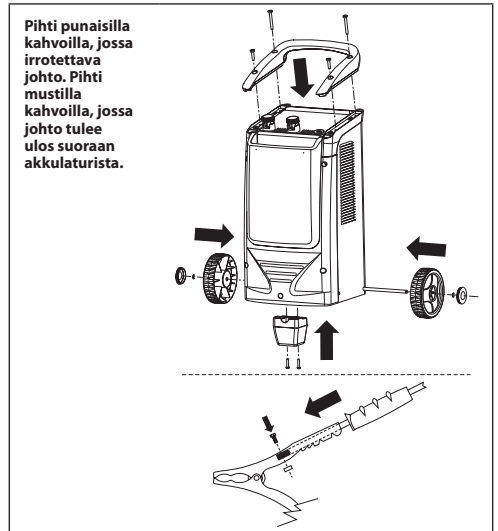

3.1 AKKULATURIN SIIJOITUS

Aseta toiminnan aikana akkulaturi vakaasti ja varmista, ettei mikään tuki ilmanalkua siihen tarkoitusta aukoista riittävän tuuletuksen takaamiseksi.

3.2 LIITÄ SÄHKÖVERKKOON

- Akkulaturi voidaan kytkeä ainoastaan virransyöttöjärjestelmään maadoitetulla nolajohtimella.
- Tarkasta, että sähköverkon jännite vastaa tietokyltissä olevaa akkulaturin toimintajännitettä.
- Virransyöttölinja on oltava varustettu suojalaitteilla, kuten sulakkeet tai automaattikatkaisimet, jotka ovat riittävän suuria sietämään laitteen maksimiabsorptiota.
- Sähköverkkoon liitos tehdään siihen tarkoitettua sähköjohtodolla.
- Mahdollisten sähköjohtojen jatkeiden leikkauksen on oltava sopiva eikä koskaan pienempi kuin laitteen sähköjohtojen leikkauksen.
- On aina välttämätöntä maadoittaa laite käyttämällä sähköjohtojen keltavihreää johdinta, jonka erottaa etiketistä (↓), kun taas kaksi muuta johdinta liitetään vaiheeseen ja sähköjohdinkäytön nolalaitteeseen.

4. TOIMINTA LATAUKSESSA

HUOMIO: Tarkasta ennen latausta, että ladattavaksi aiotun akun kapasiteetti (Ah) ei ole alle akkulaturin tietokyltissä ilmoitetun kapasiteetin (C/min). Noudata ohjeita tarkasti alla olevassa järjestyksessä.

4.1 AKUN VALMISTELU

Jos ladattava akku on tyyppiä WET, toimi seuraavalla tavalla:

- Poista akun tapit (jos mukana) niin, että latauksen aikana syntyvät kaasut pääsevät pois. - Tarkasta, että elektrolyytin taso peittää akun levyt; jos ne ovat paljaat, lisää tislattua vettä, kunnes ne uppoavat 5-10 mm.



HUOMIO! OLE MAHDOLLISIMMAN VAROVAINEN TÄMÄN TOIMENPITEEN AIKANA, KOSKA ELEKTROLYYTTI ON ERITTÄIN SYÖVYTTÄVÄ HAPPO.

4.2. AKKULATURIN/AKUN LIITÄNTÄ

- Tarkasta, että sähköjohto on irti verkkopistorasiasta.
 - Malleissa joissa on useampia latausjännitteitä, asemoi kytkin tai valitsin valitun jännitteen kohdalle. Jos kytkintä tai valitsinta ei ole paikalla, liitä johto punaisella latauspihdillä (symboli +) laturissa olevaan tarkoituksenmukaiseen liittimeen valitun latausjännitteen kohdalle.
 - Liitä punainen latauspihti akun positiiviseen liittimeen (symboli +). Jos symbolit eivät erotu, muista, että positiivinen liitin on se, jota ei ole kytketty auton runkoon.
 - Liitä musta latauspihti auton runkoon, kauas akusta ja polttoainekanavasta.
- HUOMAA: jos akku ei ole asennettu autoon, liitä suoraan akun negatiiviseen liittimeen (symboli -).

4.3 USEMMAN AKUN YHTÄAIKAINEN LATAUS

HUOMIO: älä lataa akkuja, joiden kapasiteetti, tyhjiys ja tyyppi ovat erilaisia keskenään. Jouduttaessa lataamaan samaan aikaan useita akkuja voidaan tehdä "sarja-" tai "rinnakkais"kytkentöjä: sarja

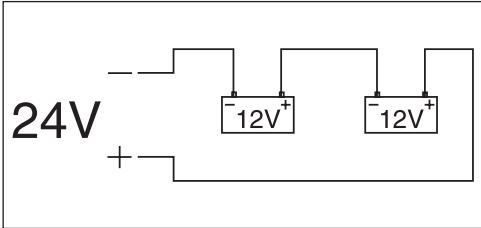

rinnakkais

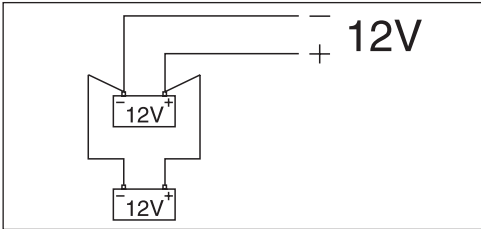

"Rinnakkais"kytkentä vaatii, että akuilla on sama nimellijännite (Volt), joka vastaa akkulatorin ulostulojännitettä ja Ah:n yhteisumma on akkulatorin latausalueella.

"Sarja"kytkentä vaatii, että akuilla on sama kapasiteetti (Ah) ja että kaikkien akkujen nimellijännitteiden yhteisumma vastaa akkulatorin ulostulojännitettä.

4.4 LATAUKSEN LOPPU

- Poista virransyöttö akkulatorista vetämällä sähköjohton pistoke pois sähköverkon pistorasiasta.
- Irrota musta latauspihti ajoneuvon rungosta tai akun negatiivisesta liittimestä (symboli -).
- Irrota punainen latauspihti akun positiivisesta liittimestä (symboli +).
- Aseta akkulatori kuivaan paikkaan.
- Sulje akun kennot siihen tarkoitetuilla tulpilla (jos mukana).

5. TOIMINTA KÄYNNISTYKSESSÄ

HUOMIO: katso ennen toimenpiteitä huolellisesti ajoneuvojen valmistajien varoitukset!

- Suojaa virransyöttölinja sulakkeilla tai automaattikatkaisimilla, joiden arvo vastaa tietokyltissä ilmoitettua arvoa symbolilla (—|—).
- Käynnistyksen helpottamiseksi tee etukäteen 10-15 minuutin pikalataus akkulatori latausasennossa EIKÄ käynnistysasennossa.
- Jos ajoneuvo ei käynnisty, odota muutama minuutti ja toista nopea

lataus. Älä jatka enempää, jos ajoneuvon moottori ei käynnisty; akku tai jopa ajoneuvon sähkölaitteisto voi vaurioitua pahasti.

5.1 AKKULATURIN/AKUN LIITÄNTÄ

- Varmista ennen ajoneuvon käynnistystä, että akun nimellijännitteen arvo vastaa akkulatoriin asetettua arvoa.
- Varmista, että akku on hyvin liitetty vastaaviin liittimiin (+ ja -), ja että liitokset akkuun ovat oikein, ja että akku on hyvässä kunnossa (ei ole sulfatoitunut eikä viallinen).
- Älä missään tapauksessa käynnistä ajoneuvoja, joiden akut ovat irti vastaavista liitoksista; akku on välttämätön mahdollisesti käynnistysvaiheiden aikana liitoskaapeleihin kerääntyvän energian vaikutuksesta johtuvien ylijännitteiden eliminoimiseksi. **Näiden määrysten huomioimatta jättäminen voi vaurioittaa ajoneuvon elektroniikkaa.**

5.2 KÄYNNISTYS

- Tämän toiminnon valitsemiseksi katso ohje "KÄYNNISTYS".

5.3 KÄYNNISTYKSEN LOPPU

- Poista sähköjohton pistoke sähköverkon pistorasiasta.
- Irrota musta latauspihti akun negatiivisesta liittimestä (symboli -) sekä punainen latauspihti akun positiivisesta liittimestä (symboli +).
- Aseta akkulatori kuivaan paikkaan.

6. AKKULATURIN SUOJAUKSET

Akkulatori suojautuu itse seuraavissa tapauksissa:

- Ylikuormitus (liiallinen virran syöttö akkuun).
- Oikosulku (keskenään kosketuksiin laitetut latauspihdit).
- Napaisuuden käänteisyys akun liittimissä.
- Sulakkeissa varustetuissa laitteissa on vaihdon yhteydessä käytettävä nimellisarvoltaan vastaavia varoasia.



HUOMIO: Sulakkeen vaihto kyltissä osoitetusta virranarvosta poikkeavaan sulakkeeseen voi aiheuttaa henkilö- tai esinevahinkoja. Samasta syystä älä mistään syystä vaihda sulaketta kuparisiltoihin tai muuhun materiaaliin. Sulakkeen vaihto on suoritettava aina virtajohto verkosta IRROTETTUNA. Toimi varovaisesti liuska-sulakkeen vaihdon aikana, mikäli asennettu, ja kiristä kiinnitysmutterin tiukalle.

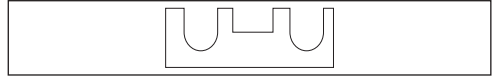

7. HYÖDYLLISIÄ NEUVOJA

- Puhdista positiivinen ja negatiivinen liitin mahdollisista oksidikertymistä niin, että varmistetaan pihtien hyvä kosketus.
- Jos akkulatorilla käytettäväksi aiottu akku on pysyvästi asennettuna ajoneuvoon, katso myös ajoneuvon ohje- ja/tai huoltokirjasta kohta "SÄHKÖASENNUS" tai "HUOLTO".



UPOZORNĚNÍ: PŘED POUŽITÍM NABÍJECKY AKUMULÁTORŮ SI POZORNĚ PŘEČTĚTE NÁVOD K POUŽITÍ!

1. ZÁKLADNÍ BEZPEČNOSTNÍ POKYNY PRO POUŽITÍ



- Zabraňte styku kyseliny s akumulátorem. V případě postříkání nebo styku s kyselinou okamžitě opláchněte zasaženou část čistou vodou. Pokračujte v oplachování až do příchodu lékaře.



- Během nabíjení se z akumulátorů uvolňují výbušné plyny, a proto zabraňte vzniku plamenů a jisker. **NEKURTE.**
- Umístěte nabíjený akumulátor do větraného prostoru.



- Chrňte si zrak. Při práci s olovenými akumulátory, které obsahují kyselinu, pokudžte používejte ochranné brýle.



- Používejte vhodný oděv. Nepoužívejte široké kusy oděvu nebo šperky, které by mohly být zachyceny pohyblivými se součástmi. Během prací se doporučuje používat ochranný, elektricky izolovaný oděv a také ochrannou protiskluzovou obuv. V případě dlouhých vlasů je třeba použít ochranu pokrývku hlavy.



- Osoby, které nemají zkušenosti se zařízením, by měly být před jeho používáním vhodné vyškoleny.
- Zařízení může být používáno dětmi ve věku nejméně 8 let a osobami se sníženými fyzickými, sensorickými nebo mentálními schopnostmi, nebo osobami bez zkušeností či potřebných znalostí, za předpokladu, že jsou pod dozorem, nebo že jim byly poskytnuty pokyny ohledně bezpečného použití zařízení a ohledně pochopení souvisejících nebezpečí.
- Děti se nesmí hrát se zařízením.
- Čištění a údržba zařízení, kterou má provést uživatel, nesmí být prováděna dětmi a bez dozoru.
- Nabíječku akumulátorů používejte pouze uvnitř a ujistěte se, že ji používáte v dobře větraných prostorech: **NEVYSTAVUJTE DEŠTI NEBO SNĚHU.**
- Před zapojením nebo odpojením nabíjecích kabelů od akumulátoru odpojte napájecí kabel ze sítě.
- Nepřipojujte ani neodpojujte kleště k/od akumulátoru během činnosti nabíječky akumulátorů.
- V žádném případě nepoužívejte nabíječku akumulátorů uvnitř vozidla nebo v prostoru motoru.
- Napájecí kabel nahradte pouze originálním kabelem.
- Když je napájecí kabel poškozen, musí být vyměněn výrobcem, jeho servisní službou nebo osobou s podobnou kvalifikací a s cílem zabránit jakémukoliv riziku.
- **Nepoužívejte nabíječku akumulátorů pro nabíjení akumulátorů, které nelze nabíjet.**
- Zkontrolujte, zda napájecí napětí, které je k dispozici, odpovídá napětí uvedenému na identifikačním štítku nabíječky akumulátorů.
- Aby nedošlo k poškození elektroniky vozidel, přísně dodržujte varování od výrobců vozidel nebo použitých akumulátorů.
- Součástí této nabíječky akumulátorů jsou komponenty, jako např. vypínač nebo relé, které mohou vyvolat vznik oblouku nebo jiskry; proto při použití nabíječky akumulátorů v autodílně nebo v podobném prostředí uložte nabíječku do místnosti nebo do obalu vhodného k tomuto účelu.
- Zásahy do vnitřních částí nabíječky akumulátorů v rámci oprav nebo údržby může provádět pouze zkušený personál.
- **UPOZORNĚNÍ: POZOR, NEBEZPEČÍ! PŘED VYKONÁNÍM JAKÉKOLI OPERACE V RÁMCI JEDNODUCHÉ ÚDRŽBY NABÍJECKY AKUMULÁTORŮ ODPOJTE NAPÁJECÍ KABEL ZE SÍTĚ!**

- **Nabíječka akumulátorů je v souladu s předpisy pro zařízení třídy I chráněna proti nepřímému dotyku zemnicím vodičem. Zkontrolujte, zda je zásuvka vybavena ochranným uzemněním.**
- U modelů, které jím nejsou vybaveny, připojujte k zásuvce zástrčky vhodné proudové kapacity s hodnotou, která není nižší než hodnota pojistky uvedená na štítku.



- **Zařízení třídy A:**

Tato nabíječka akumulátorů vyhovuje požadavkům technického standardu výrobku určeného pro použití k profesionálním účelům v průmyslovém prostředí. Není zajištěna elektromagnetická kompatibilita v domácnostech a v budovách přímo připojených k napájecí síti nízkého napětí, která zásobuje budovy pro domácí použití.

2. ZÁKLADNÍ POPIS

Nabíječka akumulátorů, která je určena pro nabíjení olovených akumulátorů WET, EFB, GEL, AGM + (Ca) a lithiových akumulátorů, používaných v motorových vozidlech (benzínových i dieselových) a elektrických vozidlech: automobilech, motorových vozidlech, motocyklech, pravidlech apod. Umožňuje nabíjet akumulátory se jmenovitým napětím 12 V a 24 V; k dispozici je také režim startování (pouze u vozidel s benzínovým a dieselovým motorem). Akumulátory, které lze nabíjet v závislosti na výstupním napětí, jež je k dispozici: 12V / 6 články; 24V / 12 článků.

3. INSTALACE MONTÁŽ

- Rozbalte nabíječku akumulátorů a proveďte montáž oddělených částí nacházejících se v obalu.
- Modely s vozíkem se instalují do svislé polohy.

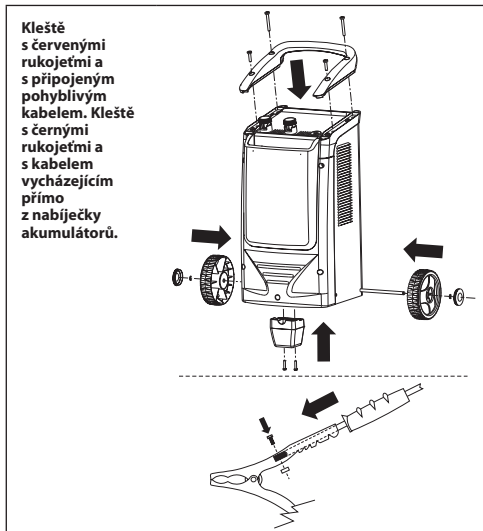

3.1 UMÍSTĚNÍ NABÍJECKY AKUMULÁTORŮ

Umístěte nabíječku akumulátorů tak, aby se během své činnosti nacházela ve stabilní poloze, a ujistěte se, že nic nebrání přístupu vzduchu příslušnými otvory a že je tedy zaručena dostatečná ventilace.

3.2 PŘIPOJENÍ DO ELEKTRICKÉ SÍTĚ

- Nabíječka akumulátorů musí být připojena výhradně k napájecímu systému s uzemněným nulovým vodičem.
- Zkontrolujte, zda napětí elektrické sítě odpovídá provoznímu napětí nabíječky akumulátorů, uvedenému na identifikačním štítku.
- Napájecí vedení bude muset být vybaveno ochrannými systémy, jako např. pojistkami nebo automatickými vypínači, schopnými snášet maximální proudovou zátěž zařízení.
- Připojení do elektrické sítě musí být provedeno prostřednictvím příslušného napájecího kabelu.
- Případné prodloužovací kabely napájecího kabelu musí mít vhodný průřez, který nesmí být v žádném případě menší než průřez napájecího kabelu zařízení.

- Vždy platí povinnost uzemnit zařízení prostřednictvím žlutozeleného vodiče napájecího kabelu, označeného štítkem (⏚), zatímco zbývající dva vodiče budou připojeny k fázovému a nulovému vodiči rozvodné elektrické sítě.

4. ČINNOST PŘI NABÍJENÍ

POZN.: Než přistoupíte k nabíjení, přesvědčte se, zda kapacita akumulátoru (Ah), který hodláte nabíjet, není nižší než kapacita uvedená na identifikačním štítku nabíječky akumulátorů (Cmin). Proveďte jednotlivé úkony dle pokynů a přísně dodržujte níže uvedený postup.

4.1 PŘÍPRAVA AKUMULÁTORŮ

Když je akumulátor určený k nabíjení typu WET, postupujte níže uvedeným způsobem:

- Odmontujte uzávěry akumulátorů (jsou-li součástí), aby se mohly uvolnit plyny vznikající při nabíjení. Zkontrolujte, zda hladina elektrolytu zakrývá desky akumulátorů; v případě, že jsou desky odhalené, dolijte destilovanou vodu tak, aby zůstaly ponořené 5 – 10 mm.



UPOZORNĚNÍ! VĚNUJTE TOMUTO ÚKONU MAXIMÁLNÍ POZORNOST, PROTOŽE ELEKTROLYT JE TVOŘEN VYSOCE KOROZIVNÍ KYSELINOU.

4.2 PŘIPOJENÍ NABÍJEČKY AKUMULÁTORŮ/AKUMULÁTORŮ

- Zkontrolujte, zda je nabíjecí kabel odpojený ze zásuvky elektrické sítě.
- Pro modely s více hodnotami nabíjecího napětí přepněte přepínač do polohy odpovídající zvolenému nabíjecímu napětí. V případě nepřítomnosti přepínače vhodně připojte kabel s červenými nabíjecími kleštěmi (symbol +) ke specifické svorce nabíječky akumulátorů, která odpovídá zvolenému nabíjecímu napětí.
- Připojte nabíjecí kleště červené barvy ke kladnému pólu akumulátorů (symbol +). Když se symboly neshodují, pamatujte, že kladný pól je ten, který není připojen k podvozku auta.
- Připojte nabíjecí kleště černé barvy k podvozku auta, v dostatečné vzdálenosti od akumulátorů a od palivového rozvodu.

POZNÁMKA: Když akumulátor není nainstalován v autě, proveďte připojení přímo k záporné svorce akumulátorů (symbol -).

4.3 SOUČASNÉ NABÍJENÍ VÍCE AKUMULÁTORŮ

UPOZORNĚNÍ: Nenabíjejte současně akumulátory odlišného druhu, s odlišnou kapacitou nebo vybíjením. V případě, že je třeba nabít více akumulátorů současně, můžete použít „sériové“ nebo „paralelní“ zapojení:

sériové zapojení

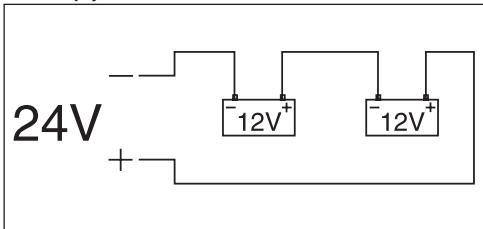

paralelní zapojení

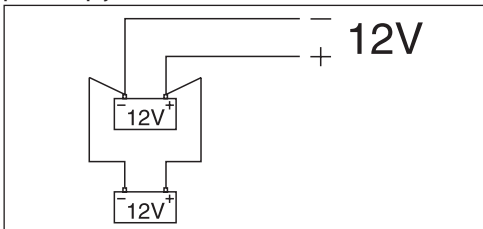

„Paralelní“ připojení vyžaduje, aby měly akumulátory stejné jmenovité napětí (volt), odpovídající výstupnímu napětí nabíječky akumulátorů, a aby se součet Ah nacházel v jejím nabíjecím rozsahu.

„Sériové“ připojení vyžaduje, aby měly akumulátory stejnou kapacitu (Ah) a aby součet jmenovitých napětí všech akumulátorů odpovídal výstupnímu napětí nabíječky akumulátorů.

4.4 UKONČENÍ NABÍJENÍ

- Odpojte napájení nabíječky akumulátorů odpojením zástrčky napájecího kabelu ze zásuvky elektrické sítě.

- Odpojte nabíjecí kleště černé barvy od podvozku vozidla nebo ze záporného pólu akumulátorů (symbol -).
- Odpojte nabíjecí kleště červené barvy od kladného pólu akumulátorů (symbol +).
- Uložte nabíječku akumulátorů na suché místo.
- Uzavřete články akumulátorů příslušnými uzávěry (jsou-li součástí).

5. ČINNOST PŘI STARTOVÁNÍ

UPOZORNĚNÍ: Před zahájením startování se důkladně seznamte s upozorněními výrobců vozidel!

- Ujistěte se, že je napájecí vedení chráněno pojistkami nebo jističi s hodnotou odpovídající jmenovité hodnotě, která je uvedena na štítku a označena symbolem (⚡).
- Pro usnadnění startování proveďte předem nabíjení, které bude trvat 10-15 minut, s nabíječkou akumulátorů přepnutou do polohy nabíjení, a NE do polohy startování.
- Když nedojde k nastartování, vyčkejte několik minut a teprve poté zopakujte úkon rychlého nabití. V případě, že nedojde k nastartování motoru vozidla, nepokračujte v pokusech o nastartování: mohlo by totiž dojít k vážnému poškození akumulátorů nebo dokonce k poškození elektroinstalace vozidla.

5.1 PŘIPOJENÍ NABÍJEČKY AKUMULÁTORŮ/AKUMULÁTORŮ

- Před zahájením startování vozidla se ujistěte, že hodnota jmenovitého napětí akumulátorů odpovídá hodnotě nastavené na nabíječce akumulátorů.
 - Ujistěte se, že je akumulátor správně připojen k příslušným svorkám (+ a -), že je připojení k akumulátoru provedeno správně a že se akumulátor nachází v dobrém stavu (nedošlo v něm k vytvoření síranu a není vadný).
 - V žádném případě neprovádějte startování vozidel s akumulátory odpojenými od příslušných svorek; přítomnost akumulátorů je určující pro odstranění případných přepětí, která by mohla vzniknout díky energii nahromaděné ve spojovacích kabelech během startování.
- Nedodržení těchto pokynů by mohlo poškodit elektroniku vozidla.**

5.2 STARTOVÁNÍ

- Ohledně volby této funkce si prohlédněte ilustraci „STARTOVÁNÍ“.

5.3 UKONČENÍ STARTOVÁNÍ

- Odpojte zástrčku napájecího kabelu ze zásuvky napájecí elektrické sítě.
- Odpojte nabíjecí kleště černé barvy od záporné svorky akumulátorů (symbol -) a červené kleště od kladné svorky akumulátorů (symbol +).
- Uložte nabíječku akumulátorů na suché místo.

6. OCHRANNÉ PRVKY NABÍJEČKY AKUMULÁTORŮ

K samoochraně nabíječky akumulátorů dochází v případě:

- Přetížení (nadměrný proud dodávaný do akumulátorů).
- Zkratu (nabíjecí kleště jsou vzájemně spojené).
- Záměny polarit na svorkách akumulátorů.

U zařízení vybavených pojistkami je v případě jejich výměny povinné použití obdobných pojistek se stejnou jmenovitou hodnotou proudu.



UPOZORNĚNÍ: Výměna pojistky za jinou s odlišnými hodnotami proudu, než jsou hodnoty uvedené na identifikačním štítku, by mohla způsobit škody na zdraví a majetku. Ze stejného důvodu se bezpodmínečně vyhněte nahrazování pojistky měděnými přestomovacími dráty nebo jiným materiálem. Operace výměny pojistky musí být pokaždé provedena s napájecím kabelem ODPOJENÝM ze sítě. Během výměny pásové pojistky, je-li součástí, věnujte pozornost řádnému utažení upevňovacích matic.

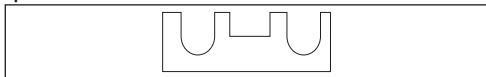

7. PRAKTICKÉ RADY

- Vyčistěte zápornou a kladnou svorku od možných nánosů oxidu, abyste zajistili dobrý kontakt kleští.
- Když je akumulátor, který se má nabíjet touto nabíječkou akumulátorů, pevně vložen do vozidla, seznamte se také s návodem k použití a/ nebo údržbě vozidla, konkrétně s částí „ELEKTROINSTALACE“ nebo „ÚDRŽBA“.



UPOZORNENIE: PRED POUŽITÍM NABÍJAČKY AKUMULÁTOROV SI POZORNE PREČÍTAJTE NÁVOD NA POUŽITIE!

1. ZÁKLADNÉ BEZPEČNOSTNÉ POKYNY PRE POUŽITIE



- Zabráňte styku kyseliny akumulátora s pokožkou. V prípade postriekania alebo kontaktu s kyselinou okamžite opláchnite zasiahnutú časť čistou vodou. Neustále oplachujte, až do príchodu lekára.



- Počas nabíjania sa z akumulátorov uvoľňujú výbušné plyny a preto zabráňte vzniku plameňov a iskier. NEFAJČITE.
- Umiestnite nabíjajúci akumulátor do vetraného priestoru.



- Chráňte si zrak. Pri práci s olovenými akumulátormi, ktoré obsahujú kyselinu, vždy používajte ochranné okuliare.



- Vhodne sa oblečte. Nepoužívajte voľné kusy odevu alebo šperky, ktoré by mohli byť zachytené pohybujúcimi sa časťami. Počas prác sa odporúča používať ochranný elektricky izolovaný odev a tiež ochrannú protišmykovú obuv. V prípade dlhých vlasov je potrebné používať ochrannú pokrývku hlavy.



- Osoby, ktoré nemajú skúsenosti so zariadením, by mali byť pred jeho používaním vhodne vyškolené.
- Zariadenie môžu používať deti, ak majú najmenej 8 rokov, a osoby so zníženými fyzickými, zmyslovými alebo mentálnymi schopnosťami, alebo osoby bez skúseností alebo potrebných znalostí, za predpokladu, že sú pod dozorom, alebo že im boli poskytnuté pokyny ohľadom bezpečného použitia zariadenia a ohľadom pochopenia súvisiacich nebezpečenstiev.
- Deti sa nesmú so zariadením hrať.
- Čistenie a údržbu zariadenia, ktoré má vykonať užívateľ, nesmú vykonávať deti bez dozoru.
- Nabíjačku akumulátorov používajte len v interiéri a uistite sa, že ju používate v dostatočne vetraných priestoroch: NEVYSTAVUJTE DAŽDU ALEBO SNĚHU.
- Pred zapojením alebo odpojením nabíjajúcich káblov od akumulátora odpojte napájací kábel zo siete.
- Nepripájajte ani neodpájajte kliešte ku/od akumulátora počas činnosti nabíjačky akumulátorov.
- V žiadnom prípade nepoužívajte nabíjačku akumulátorov vo vnútri vozidla alebo v priestore motora.
- Napájací kábel nahradte iba originálnym káblom.
- Keď je napájací kábel poškodený, musí byť vymenený výrobcom alebo jeho servisnou službou, alebo osobou s podobnou kvalifikáciou, aby sa zabránilo akémukoľvek riziku.
- Nepoužívajte nabíjačku akumulátorov pre nabíjanie nenabíjateľných akumulátorov.
- Skontrolujte, či napájacie napätie, ktoré je k dispozícii odpovedá napätiu uvedenému na identifikačnom štítku nabíjačky akumulátorov.
- Aby nedošlo k poškodeniu elektroniky vozidiel, prísne dodržujte varovania od výrobcov vozidiel alebo použitých akumulátorov.
- Súčasť tejto nabíjačky akumulátorov sú komponenty, ako napr. vypínače alebo relé, ktoré môžu vyvolať vznik oblúku alebo iskry; preto pri použití nabíjačky akumulátorov v autodielni alebo v podobnom prostredí, uložte nabíjačku do miestnosti alebo do obalu vhodného na tento účel.
- Zásahy do vnútorných častí nabíjačky akumulátorov v rámci opravy alebo údržby môže vykonať už len skúsený personál.
- **UPOZORNENIE: POZOR, NEBEZPEČENSTVO! PRED VYKONANÍM AKÉKOLVEK OPERÁCIE V RÁMCI JEDNODUCHEJ ÚDRŽBY**

NABÍJAČKY AKUMULÁTOROV, ODPOJTE NAPÁJACÍ KÁBEL ZO SIETE!

- Nabíjačka akumulátorov je chránená proti nepriamemu dotyku zemiacim vodičom, v súlade s predpismi pre zariadenia triedy I. Skontrolujte, či je zásuvka vybavená ochranným uzmenením.
- Modely, ktoré ním nie sú vybavené, pripájajte k zásuvke zástrčky s vhodnou prúdovou kapacitou, s hodnotou, ktorá nie je nižšia ako odpovedajúca hodnota poistky uvedená na štítku.



- Zariadenie triedy A:

Táto nabíjačka akumulátorov vyhovuje požiadavkám technického štandardu výrobcu, určeného pre použitie v priemyselnom prostredí a na profesionálne účely. Nie je zaistená elektromagnetická kompatibilita v domácich budovách a v budovách priamo pripojených k napájacej sieti nízkeho napätia, ktorá zásobuje budovy pre domáce použitie.

2. ZÁKLADNÝ POPIS

Nabíjačka akumulátorov, určená pre nabíjanie olovených akumulátorov WET, EFB, GEL, AGM + (Ca) a litiových akumulátorov, používaných v motorových vozidlách (benzínových i dieselových) a elektrických vozidlách: automobiloch, motorových vozidlách, motocykloch, plavidlách, atď. Umožňuje nabíjať akumulátory s menovitým napätím 12 V a 24 V; je k dispozícii navyše s režimom štartovania (len pre vozidlá s benzínovým a dieselovým motorom). Akumulátory nabíjateľné v závislosti od daného výstupného napätia: 12V / 6 článkov; 24V / 12 článkov.

3. INŠTALÁCIA

MONTÁŽ

- Rozbaľte nabíjačku a vykonajte montáž oddelených častí nachádzajúcich sa v obale.
- Modely s vozikom sa inštalujú do zvislej polohy.

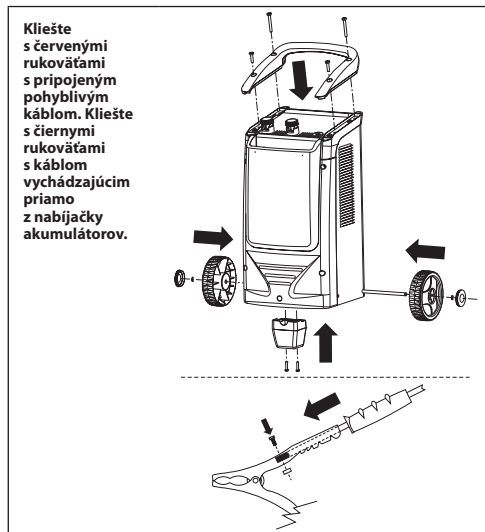

3.1 UMIESTNENIE NABÍJAČKY

Umiestnite nabíjačku akumulátorov tak, aby sa v priebehu svojej činnosti nachádzala v stabilnej polohe a uistite sa, že nič nebráni prístupu vzduchu príslušným otvorom a že je teda zaručená dostatočná ventilácia.

3.2 PRIPOJENIE DO ELEKTRICKEJ SIETE

- Nabíjačka akumulátorov musí byť pripojená výhradne k napájaciu systému s uzmeneným nulovým vodičom.
- Skontrolujte, či napätie elektrickej siete zodpovedá prevádzkovému napätiu nabíjačky akumulátorov, uvedenému na identifikačnom štítku.
- Napájacie vedenie bude musieť byť vybavené ochrannými systémami, ako napr. poistkami alebo automatickými vypínačmi, schopnými znášať maximálnu prúdovú záťaž zariadenia.
- Pripojenie do elektrickej siete musí byť vykonané prostredníctvom príslušného napájacieho kábla.

- Prípadné predlžovacie káble napájacieho kábla musia mať vhodný prierez, ktorý nesmie byť v žiadnom prípade menší ako prierez napájacieho kábla zariadenia.
- Vždy platí povinnosť uzemniť zariadenie prostredníctvom žltozeleného vodiča napájacieho kábla, označeného štítkom (↓), zatiaľ čo zvyšné dva vodiče budú pripojené k fázovému a k nulovému vodiču rozvodnej elektrickej siete.

4. ČINNOSŤ PRI NABÍJANÍ

POZN.: Pred nabíjaním sa presvedčte, či kapacita akumulátora (Ah), ktorý chcete nabíjať, nie je nižšia ako kapacita uvedená na identifikačnom štítku nabíjačky akumulátorov (Cmin). Vykonajte jednotlivé úkony, pričom striktne dodržujte nižšie uvedené postupy.

4.1 PRÍPRAVA AKUMULÁTORA

Keď je nabíjaný akumulátor typu WET, postupujte nižšie uvedeným spôsobom:

- Odmontujte zátky akumulátorov (ak sú súčasťou), aby sa mohli uvoľniť plyny vznikajúce pri nabíjaní. Skontrolujte, či hladina elektrolytu zakrýva dosky akumulátora; v prípade, že sú odhalené, dolejte destilovanú vodu tak, aby zostali ponorené 5 – 10 mm.



UPOZORNENIE! VENUJTE TEJTO OPERÁCII MAXIMÁLNU POZORNOSŤ, PRETOŽE ELEKTROLYT JE TVORENÝ VYSOKO KORÓZÍVNOU KYSELINOU.

4.2 PRIPOJENIE NABÍJAČKY AKUMULÁTOROV/AKUMULÁTORA

- Skontrolujte, či je nabíjací kábel odpojený zo zásuvky elektrickej siete.
 - Pri modeloch s voľbou nabíjacieho napätia prepnete prepínač do polohy odpovedajúcej zvolenému nabíjaciemu napätiu. Ak prepínač na nabíjačke nie je, pripojte kábel s červenými nabíjacími kliešťami (symbol +) k svorkе nabíjačky akumulátorov, ktorá odpovedá zvolenému nabíjaciemu napätiu.
 - Pripojte nabíjacie kliešte červenej farby ku kladnému pólu akumulátora (symbol +). Keď sa symboly nezhodujú, pamätajte, že kladný pól je ten, ktorý nie je pripojený k podvozku auta.
 - Pripojte nabíjacie kliešte čiernej farby k podvozku auta, v dostatočnej vzdialenosti od akumulátora a od palivového rozvodu.
- POZNÁMKA: Ak nie je akumulátor nainštalovaný v aute, pripojte kábel priamo k zápornej svorkе akumulátora (symbol -).

4.3 SÚČASNÉ NABÍJANIE VIACERÝCH AKUMULÁTOROV

UPOZORNENIE: nenabíjajte súčasne akumulátory odlišného druhu, s odlišnou kapacitou alebo vybíjaním. V prípade, keď je potrebné nabiť viaceré akumulátory súčasne, môžete použiť „sériové“ alebo „paralelné“ zapojenie:

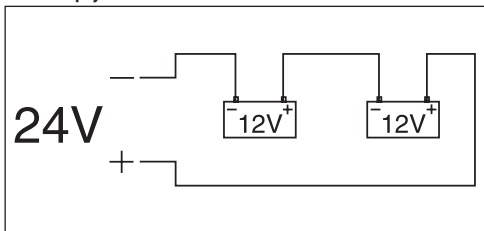

paralelné zapojenie

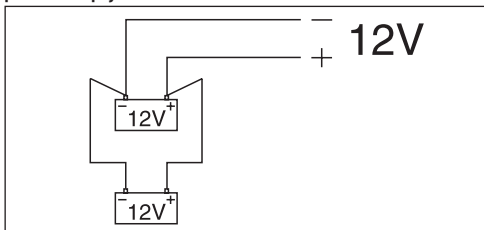

„Paralelné“ pripojenie vyžaduje, aby mali akumulátory rovnaké menovité napätie (Volt), odpovedajúce výstupnému napätiu nabíjačky akumulátorov, a aby bol súčet Ah v jej nabíjacom rozsahu.

„Sériové“ pripojenie vyžaduje, aby mali akumulátory rovnakú kapacitu (Ah) a aby súčet menovitých napätí všetkých akumulátorov odpovedal výstupnému napätiu nabíjačky akumulátorov.

4.4 UKONČENIE NABÍJANIA

- Odpojte napájanie nabíjačky akumulátorov odpojením zástrčky

napájacieho kábla zo zásuvky elektrickej siete.

- Odpojte nabíjacie kliešte čiernej farby od podvozku vozidla alebo zo záporného pólu akumulátora (symbol -).
- Odpojte nabíjacie kliešte červenej farby z kladného pólu akumulátora (symbol +).
- Uložte nabíjačku akumulátorov na suché miesto.
- Uzatvorte články akumulátora príslušnými zátkami (ak sú súčasťou).

5. ČINNOSŤ PRI ŠTARTOVANÍ

UPOZORNENIE: Pred štartovaním sa dôkladne oboznámte s upozoreniami výrobcov vozidiel!

- Uistite sa, že je napájacie vedenie chránené poistkami alebo ističmi s hodnotou odpovedajúcou menovitej hodnote uvedenej na štítku a označenej symbolom (———).
- Pre uloženie štartovania nabite predtým akumulátor po dobu 10-15 minút s nabíjačkou v polohe pre nabíjanie a NIE v polohe pre štartovanie.
- Ak motor nenaštartujete, vyčkajte niekoľko minút, a potom zopakujte úkon rýchleho nabíania. Ak motor vozidla nenaštartujete, nepokúšajte sa o opätovné naštartovanie: mohlo by skutočne dôjsť k vážnemu poškodeniu akumulátora alebo dokonca k poškodeniu elektroinštalácie vozidla.

5.1 PRIPOJENIE NABÍJAČKY AKUMULÁTOROV/AKUMULÁTORA

- Pred zahájením štartovania vozidla sa uistite, že hodnota menovitého napätia akumulátora zodpovedá hodnote nastavenej na nabíjačke akumulátorov.
 - Uistite sa, že je akumulátor správne pripojený k príslušným svorkám (+ a -), že pripojenie k akumulátoru je vykonané správne a že akumulátor sa nachádza v dobrom stave (nedošlo v ňom k vytvoreniu síranu a nie je chybny).
 - V žiadnom prípade neštartujte vozidlo s akumulátorom odpojeným od príslušných svoriek; prítomnosť akumulátora je určujúca na odstránenie prípadných prepätí, ktoré by mohli vzniknúť vďaka energii nahromadenej v spojovacích kábloch počas štartovania.
- Nedodržanie týchto pokynov by mohlo poškodiť elektroniku vozidla.**

5.2 ŠTARTOVANIE

- Ohľadom voľby tejto funkcie si pozrite ilustráciu „ŠTARTOVANIE“.

5.3 UKONČENIE ŠTARTOVANIA

- Odpojte zástrčku napájacieho kábla zo zásuvky napájacej elektrickej siete.
- Odpojte nabíjacie kliešte čiernej farby od zápornej svorky akumulátora (symbol -) a červené kliešte od kladnej svorky akumulátora (symbol +).
- Uložte nabíjačku akumulátorov na suché miesto.

6. OCHRANNÉ PRVKY NABÍJAČKY AKUMULÁTOROV

K samoochrane nabíjačky akumulátorov dochádza v prípade:

- Pretaženia (nadmerný prúd dodávaný do akumulátora).
- Skrátu (nabíjacie kliešte vzájomne spojené).
- Záměny polaritu na svorkách akumulátora.

U zariadení vybavených poistkami je v prípade ich výmeny povinné použitie obdobných poistiek s rovnakou menovitou hodnotou.



UPOZORNENIE: Použitie poistky s odlišnými hodnotami prúdu, ako sú hodnoty uvedené na identifikačnom štítku, by mohla spôsobiť škody na zdraví a majetku. Z rovnakého dôvodu v žiadnom prípade nenahradzujte poistky medenými premostovacími drôti alebo iným vodivým materiálom. Poistka musí byť vždy menená s napájacím káblom ODPOJENÝM zo siete. Počas výmeny pásovej poistky – ak je súčasťou – venujte pozornosť riadnemu utiahnutiu upevňovacích matic.

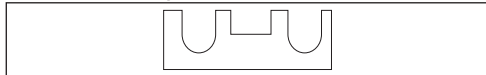

7. PRAKTICKÉ RADY

- Vyčistite zápornú a kladnú svorku od možných nánosov oxidu, aby ste zaistili dobrý kontakt klieští.
- Keď je akumulátor, ktorý má byť nabíjaný nabíjačkou akumulátorov napaveno vložený do vozidla, zoznámte sa tiež s návodom na použitie a/alebo údržbu vozidla, konkrétne s časťou „ELEKTROINŠTALÁCIA“ alebo „ÚDRŽBA“.



OPOZORILO: PREDEN ZAČNETE UPORABLJATI POLNILNIK AKUMULATORJEV, POZORNO PREBERITE PRIROČNIK ZA UPORABO!

1. SPLOŠNA VARNOST PRI UPORABI



- Izogibajte se stiku s kislino iz akumulatorja. Če vas bo poškropilo ali če boste prišli v stik s kislino, takoj splaknite oškropljeni del s čisto vodo. Splakujte, dokler ne pride do vas zdravnik.



- Med samim polnjenjem baterija oddaja eksplozivne pline, preprečite da ne pride do iskretnja in plamena. **PREPOVEDANO KAJENJE.**
- Baterije, ki se polnijo, namestiti v zračen prostor.



- Zaščitite si oči. Ko delate s svinčovo-kislinskimi akumulatorji vedno uporabljajte zaščitna očala.



- Vedno nosite primerna oblačila. Ne nosite širokih oblačil ali nakita, ki bi se lahko zapletli v mobilne dele naprave. Svetujemo vam, da med delom uporabljate zaščitno obleko z električno izolacijo in protizdrsne čevlje. Če imate dolge lase, uporabljajte varovalno pokrivalo.



- Neizkušeno osebe je treba pred uporabo naprave primerno poučiti.
- Napravo smejo otroci, ki starejši od 8 let, osebe z zmanjšanimi fizičnimi, čutilni ali umskimi zmognostmi, ali osebe, ki z njo nimajo izkušenj ali je ne poznajo, uporabljati le pod nadzorom odraslih oseb, ki so dobile navodila o varni rabi naprave, ter so razumele, kakšno nevarnost lahko povzročita naprava.
- Otroci se z napravo ne smejo igrati.
- Čiščenja in vzdrževanja, ki ju mora izvajati uporabnik, ne smejo izvajati otroci brez nadzora.
- Uporabljati polnilce baterij izključno v notranjosti in se poprej prepričati, da se delo izvaja v dobro zračenih prostorih: **NE IZPOSTAVLJATI DEŽJU ALI SNEGU.**
- Izključiti napojni kabel iz električnega omrežja preden priključite napojne kable baterije.
- Ne vezati ali odvezati ščipalke na baterijo z polnilcem baterije v delovanju.
- V nobenem primeru ne uporabljati polnilca baterij v notranjosti vozila in niti v prtljžniku avta.
- Napojni kabel zamenjati samo z originalnimi rezervnimi deli.
- Če je napajalni kabel poškodovan, ga mora zamenjati proizvajalec ali njegov tehnični servisni center ali podobno usposobljena oseba, tako da ne bi prišlo do kakršnih koli tveganj.
- Ne uporabljati polnilca baterij za polnjenje baterij ki se ne polnijo.
- Preveriti, da je napetost napajanja ustrezna označeni na tablici podatkov polnilca baterij.
- Da ne bi poškodovali elektronike v vozilu, skrbno upoštevajte opozorila proizvajalca in uporabljenih akumulatorjev.
- Ta polnilce baterij zajema dele kot sta stiko in rele, katere lahko povzročita električno napetost most ali iskretnje, zato ga je potrebno shraniti in namestiti v primernih prostorih ali zaščititi pred vžigom; še posebej, ko se uporablja v delavnici ali podobnih prostorih.
- Vzdrževalna in popravilna dela v notranjosti polnilca baterij se lahko izvajajo samo s strani izvedenca; oseba, ki je poučeno za takšno delo.
- **POZOR: ZMERAJ POPREJ IZKLJUČITI NAPAVALNI KABEL IZ ELEKTRIČNEGA OMREŽJA, PREDEN SE IZVAJA KAKRŠEN KOLI VZDRŽEVALNI POSEG POLNILCA BATERIJ, NEVARNOST!**

- Polnilnik akumulatorjev je zaščiteno pred neposrednim stikom z ozemljitvijo, kot je predpisano za naprave I. razreda. Preverite, da je vtičnica opremljena z zaščitno ozemljitvijo.
- Pri modelih, kjer ni tako, povežite vtič z ustreznim razponom na varovalko z vrednostjo, navedeno na ploščici.



- Naprava A razreda: Polnilnik akumulatorjev je skladen z zahtevami tehničnega standarda izdelka, ki je izdelan izključno za rabo v industrijskem okolju in za profesionalno rabo. Elektromagnetska združljivost v domovih in v zgradbah, neposredno povezanih v nizkonapetostno napajalno omrežje, ki napaja zgradbe za domačo rabo, ni zagotovljena.

2. SPLOŠNI OPIS

Polnilnik akumulatorjev za polnjenje svinčevih akumulatorjev WET, EFB, GEL, AGM + (Ca) in litijevih akumulatorjev Li, ki se uporabljajo v motornih vozilih (bencinskih in dizel) in v električnih vozilih: avtomobilih, motornih vozilih, motorjih, plovilih itd. Mogoče je polniti akumulatorje 12 V in 24 V; predviden je tudi način za pomoč pri zagonu motorja (samo za vozila z bencinskimi in dizel motorji).

Akumulatorji za polnjenje z naslednjimi razpoložljivimi napetostmi: 12V / 6 celic; 24V / 12 celic.

3. NAMESTITVE SESTAVLJANJE

- Iz ovoja odstranite polnilnik akumulatorjev, pritrдите priložene dele, ki so v embalaži.
- Modeli z vozički se nameščajo v vertikalni položaj.

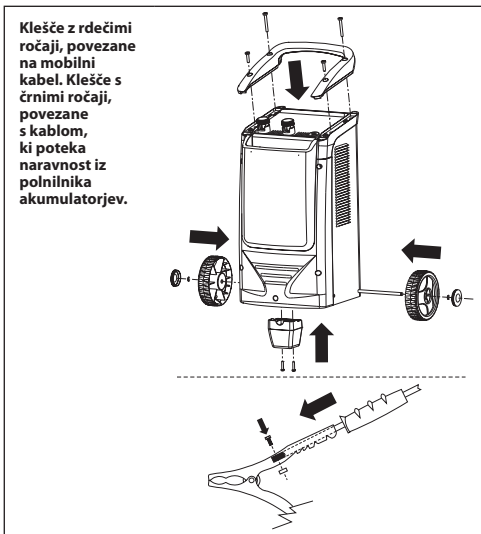

Klešče z rdečimi ročaji, povezane na mobilni kabel. Klešče s črnimi ročaji, povezane s kablom, ki poteka naravnost iz polnilnika akumulatorjev.

3.1 UMESTITEV POLNILNIKA AKUMULATORJEV

Med delovanjem morate polnilnik postaviti stabilno in morate zagotoviti, da ni pretok zraka skozi za to namenjene reže nikjer oviran in da je zračenje zadostno.

3.2 Povezava v električno omrežje

- Polnilnik akumulatorjev se lahko priključi izključno v napajalni sistem, ki ima ozemljeno ničlo.
- Preverite, da napetost električnega omrežja ustreza delovni napetosti polnilnika akumulatorjev, navedeni na ploščici s podatki.
- Napajalna linija mora biti opremljena z zaščitnimi sistemi, kot so varovalke ali samodejna stikala, ki morajo biti dovolj močni, preprečujejo maksimalno absorpcijo naprave.
- Priključitev v električno omrežje je treba izvesti z ustreznim napajalnim kablom.
- Morebitni podaljški napajalnega kabla morajo imeti ustrezen prerez in ne smejo biti tanjši od napajalnega kabla naprave.
- Aparat morate vedno priključiti na ozemljitev. Za to uporabite rumeno-zeleni napajalni kabel, označen z oznako (⏚), druga dva vodnika pa priključite na fazo in na ničlo.

4. DELOVANJE PRI POLNENJU

OPOZORILO: Preden nadaljujete polnjenje, preverite, da zmogljivost akumulatorja (Ah), ki ga nameravate polniti, ni manjša od navedene na ploščici s podatki o polnilniku akumulatorjev (Cmin). Korake navodil skrbno izvedite v navedenem vrstnem redu.

4.1 PRIPRAVA AKUMULATORJA

Če želite polniti akumulator tipa WET, postopajte, kot sledi:

- Če so nameščeni, odstranite pokrovice na akumulatorju, tako da lahko normalno izhlapevajo plini, ki nastajajo med polnjenjem v akumulatorju. Preverite, da je v akumulatorju toliko elektrolita, da pokriva plošče; če gledajo ven iz elektrolita, dolijte destilirano vodo, dokler ne sega gladina za 5-10 mm nad plošče.



POZOR! PRI TEM PAZITE, SAJ JE ELEKTROLIT IZJEMNO KOROZIVNA KISLINA.

4.2 PRIKLOP POLNILNIKA AKUMULATORJEV/AKUMULATORJA

- Preverite, da je napajalni kabel izklopljen iz omrežne vtičnice.
- Pri modelih z več napetostmi polnjenja preklopnik ali smerno pretikalo prestavite tako, da bosta ustrezala izbrani napajalni napetosti. Če preklopnika ali smernega pretikalca ni, ustrezno priključite kabel z rdečimi kleščami (simbol +) na ustrezni stičnik polnilnika v skladu z izbrano napajalno napetostjo.
- Priključite klešče za polnjenje rdeče barve na pozitivni priključek akumulatorja (simbol +). Če simboli niso več razločni, si zapomnite, da je pozitivni priključek tisti, ki ni povezan z ohišjem avtomobila.
- Priključite klešče za polnjenje črne barve na ohišje vozila, stran od akumulatorja in od vodov za dovajanje goriva.
POZOR: če akumulator ni v vozilu, klešče črne barve povežite neposredno na negativni priključek akumulatorja (simbol -).

4.3 SOČASNO POLNJENJE VEČ AKUMULATORJEV

OPOZORILO: ne polnite akumulatorjev, ki se med seboj razlikujejo po zmogljivosti, razelektrjenju in tipu. Če morate sočasno napolniti več akumulatorjev, lahko to storite z »zaporednim« ali »vzporednim« povezovanjem:

zaporedno

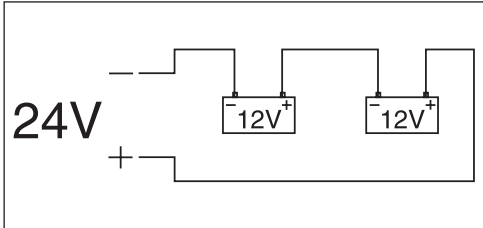

vzporedno

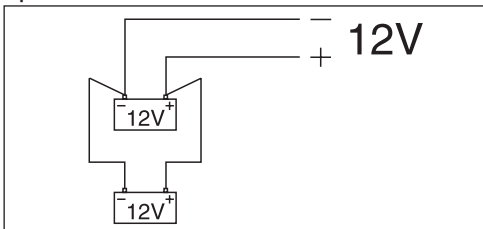

»Vzporedna« vezava akumulatorjev zahteva enako nazivno napetost (v voltih), ki ustreza izhodni napetosti polnilnika akumulatorjev, in da je vsota Ah akumulatorjev znotraj obsega polnilnika.

»Zaporedna« vezava akumulatorjev zahteva enako zmogljivost (Ah) in da je vsota nazivnih napetosti akumulatorjev enaka izhodni napetosti polnilnika.

4.4 KONEC POLNJENJA

- Odklopite napajanje polnilnika akumulatorjev, tako da iztaknete vtič napajalnega kabla iz omrežne vtičnice.
- Odklopite črne klešče za polnjenje z ohišja vozila ali z negativnega priključka akumulatorja, (simbol -).
- Odklopite rdeče klešče za polnjenje s pozitivnega priključka na akumulatorju (simbol +).
- Polnilnik akumulatorjev shranite na suho mesto.
- Celice akumulatorja zaprite z ustreznimi pokrovciki (če so priloženi).

5. DELOVANJE PRI ZAGONU

OPOZORILO: preden nadaljujete, skrbno preglejte opozorila izdelovalcev vozil!

- Prepričajte se, da je napajalna linija zaščiten z varovalkami ali samodejnimi prekinjalji, ki ustrezajo vrednosti, navedeni na ploščici s podatki, označeni s simbolom ().
- Da bi olajšali zagon, predhodno izvedite hitro polnjenje za 10-15 minut, pri čemer naj bo polnilnik akumulatorjev v položaju za polnjenje, NE za zagon.
- Če se vozilo ne zažene, nekaj minut počakajte in ponovite postopek hitrega polnjenja. Ne vztrajajte predolgo, če se motor vozila ne zažene; lahko bi namreč hudo ogrozili akumulator ali celotno električno napeljavo vozila.

5.1 PRIKLOP POLNILNIKA AKUMULATORJEV/AKUMULATORJA

- Pred zagonom vozila preverite, ali nazivna napetost akumulatorja ustreza nastavljeni vrednosti polnilnika akumulatorjev.
- Prepričajte se, da je akumulator povezan na ustrezne stičnike (+ in -), da so povezave z akumulatorjem pravilne in da je akumulator v dobrem stanju (ni sulfatiran in ni pokvarjen).
- Zagona vozila absolutno ne izvajajte, ko so akumulatorji odklopljeni z ustreznih stičnikov; prisotnost akumulatorja je bistvena, da ne bi prišlo do morebitne prenapetosti zaradi energije, ki bi se nabrala v povezovalnih kablilih med zagonom. **Če teh navodil ne boste upoštevali, lahko poškodujete elektroniko vozila.**

5.2 ZAGON

- Da bi izbrali to funkcijo, glejte risbo "POMOČ PRI ZAGONU".

5.3 KONEC ZAGONA

- Odstranite vtič napajalnega kabla iz vtičnice napajalnega omrežja.
- Odklopite črne klešče polnilnika z negativnega stičnika (simbol -) in rdeče klešče s pozitivnega stičnika na akumulatorju (simbol +).
- Polnilnik akumulatorjev shranite na suho mesto.

6. ZAŠČITA POLNILNIKA AKUMULATORJEV

Samozaščita se na polnilniku akumulatorjev sproži, če pride do:

- Preobremenitve (prevelikega oddajanja toka proti akumulatorju).
- Kratkega stika (klešče za polnjenje v stiku).
- Obrnjene polaritete na priključkih akumulatorja.

V napravah, opremljenih z varovalkami, je v primeru zamenjave obvezno treba uporabljati zamenjave z enakimi vrednostmi, kakor je nazivna vrednost.



OPOZORILO: Če zamenjate varovalko z vrednostmi toka, ki se razlikujejo od tistih na ploščici, to lahko poškoduje stvari ali ljudi. Iz istega razloga se kar čimbolj izogibajte zamenjave varovalke z bakrenimi mostički ali drugim materialom. Postopek zamenjave varovalke je treba vedno izvesti, ko je napajalni kabel **IZKLOPLJEN** iz omrežja. Med zamenjavo varovalke s trakom, kjer je prisotna, bodite pozorni, in trdno privijte pritrditvene matice.

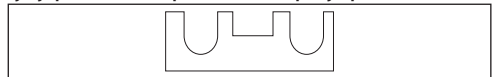

7. UPORABNI NASVETI

- Očistite pozitivni in negativni pol morebitnih rjastih oblog, tako da zagotovite dober prijem klešč.
- Če je akumulator, na katerem nameravate uporabiti polnilnik, stalno nameščen na vozilu, preberite tudi priročnik z navodili ali za vzdrževanje vozila, poglavje "ELEKTRIČNA NAPELJAVA" ali "VZDRŽEVANJE".



POZOR: PRIJE UPOTREBE PUNJAČA BATERIJE PAŽLJIVO PROČITATI PRIRUČNIK ZA UPOTREBU!

1. OPĆA SIGURNOST PRILIKOM UPOTREBE



- Izbjegavati dodir sa kiselinom iz baterije. U slučaju prskanja kiselinom ili dodira sa istom, odmah isprati zahvaćeni dio čistom vodom. Nastaviti sa ispiranjem do dolaska liječnika.



- Tijekom punjenja baterije ispuštaju eksplozivne plinove, potrebno je izbjegavati stvaranje plamena i iskre. **ZABRANJENO JE PUŠENJE.**
- Potrebno je staviti baterije na punjenje u dobro prozračeno mjesto.



- Zaštiti oči. Uvijek je potrebno nositi zaštitne naočale kada se radi sa akumulatorima na bazi olova i kiseline.



- Potrebno je odjenuti prikladnu odjeću. Ne smiju se koristiti široki odjevni predmeti ili nakit koji bi mogli zapeti za dijelove u pokretu. Tijekom rada potrebno je odjenuti zaštitnu odjeću sa prikladnom električnom izolacijom kao i cipele protiv klizanja. Kod duge kose potrebno je koristiti prikladnu kacigu.



- Neiskusne osobe moraju dobiti prikladnu obuku prije upotrebe uređaja.
- Aparat mogu koristiti djeca od 8 i više godina starosti kao i osobe sa smanjenim fizičkim, osjetnim i psihičkim sposobnostima ukoliko su pod nadzorom ili pak nakon što su obučene za sigurno korištenje aparata i ukoliko su shvatile opasnosti koje mogu nastati prilikom uporabe istog.
- Djeca se ne smiju igrati aparatom.
- Čišćenje i održavanje koje treba izvršiti korisnik ne smiju vršiti djeca bez nadzora odraslih.
- Punjač baterija se mora koristiti isključivo u unutarnjim prostorijama i potrebno je provjeriti da su prostorije dobro prozračene: **NE SMIJE SE IZLAGATI NA KIŠI ILI SNIEGU.**
- Isključiti kabel za napajanje iz priključka prije priključivanja ili isključivanja kablova za napajanje baterije.
- Ne smiju se priključivati ili isključivati hvataljke na bateriju dok je punjač baterija uključen.
- Nikako se ne smije upotrebljavati punjač baterija unutar vozila ili haube.
- Kabel za napajanje je potrebno zamijeniti isključivo originalnim kablom.
- Ako je kabel za napajanje oštećen, isti mora zamijeniti proizvođač ili njegov servis za tehničku asistenciju odnosno osoba koja ima sličnu kvalifikaciju kako ne bi nastali rizici.
- Ne smije se koristiti punjač za baterije sa punjenje baterija koje se ne mogu ponovno puniti.
- Provjeriti da napon napajanja na raspolaganju odgovara naponu navedenom na na pločici sa podacima na punjaču baterija.
- Kako se ne bi oštetila elektronika vozila, potrebno je striktno poštivati upute proizvođača vozila ili upotrebljenih baterija.
- Ovaj punjač baterija sadrži dijelove kao na primjer prekidače ili releje, koji mogu izazvati strujne krugove ili iskre; stoga ako se upotrebljava u garaži ili u sličnom ambijentu, odložiti punjač u prostor ili kutiju koja je prikladna za tu svrhu.
- Popravke ili servisiranje unutarnjeg dijela punjačmogu vršiti isključustručosobe.
- **POZOR: UVIJEK JE POTREBNO ISKLJUČITI KABEL ZA NAPAJANJE IZ MREŽE PRIJE POČIMANJA BILO KOJEG JEDNOSTAVNOG ZAHVATA SERVISIRANJA PUNJAČA, OPASNOST!**

- Punjač baterije je zaštićen od neizvravnih dodira putem sprovodnika uzemljenja, kao što se nalaze za uređaje klase I. Provjeriti da utičnica ima zaštitno uzemljenje.
- Kod modela kod kojih nisu prisutni, spojiti utikače prikladne snage koja nije niža od vrijednosti osigurača navedenog na pločici sa podacima.



- Uređaj klase A:

Ovaj punjač baterija zadovoljava uvjete tehničkih standarda proizvođa za upotrebu u industriji i na profesionalnoj razini. Ne jamči se elektromagnetska kompatibilnost kod upotrebe u domaćinstvu i u zgradama spojenim na mrežu napajanja pod niskim naponom koja napaja domaćinstva.

2. OPĆI OPIS

Punjač akumulatora namijenjen za punjenje olovnih akumulatora WET, EFB, GEL, AGM + (Ca) i litijskih akumulatora koji se koriste u motornim (benzinskim i dieseli) i električnim vozilima: automobilima, motornim vozilima, motociklima, brodovima itd. Moguće je puniti akumulare od 12V, 24V; predviđen je i režim puštanja u pogon (samo za vozila s benzinskim i dieseli motorima). Akumulatori koji se mogu puniti ovisno o dostupnom izlaznom naponu: 12V / 6 ćelije; 24V / 12 ćelija.

3. INSTALIRANJE

MONTAŽA

- Izvadite punjač akumulatora iz ambalaže, namontirajte rastavljene dijelove koji se nalaze u ambalaži.
- Modeli s kolicima trebaju se instalirati u okomitom položaju.

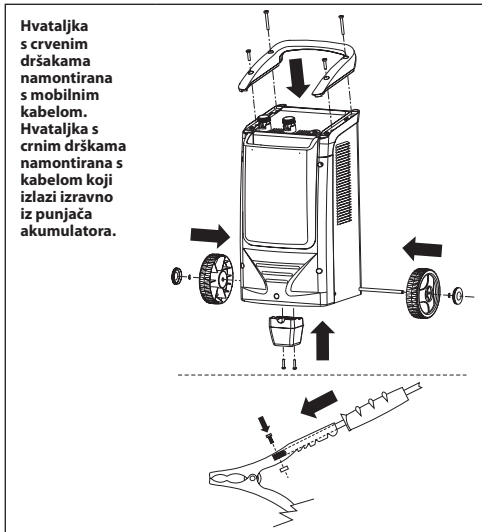

3.1 POLOŽAJ PUNJAČA BATERIJE

Tijekom rada, postaviti uređaj u stabilan položaj i provjeriti da je osiguran prolaz zraka kroz prikladne otvore kako bi se zajamčilo dovoljno zračenje.

3.2 SPAJANJE NA ELEKTRIČNU MREŽU

- Punjač baterija mora biti spojen isključivo na sustav napajanja sa neutralnim sprovodnikom spojenim na uzemljenje.
- Provjeriti da napon električne mreže odgovara naponu rada punjača baterije navedenom na pločici sa podacima.
- Sustav napajanja mora biti zaštićen sigurnosnim napravama, kao osigurači ili automatske sklopke, dovoljne snage za maksimalnu apsorpciju uređaja.
- Spajanje na električnu mrežu mora biti izvršeno prikladnim kablom za napajanje.
- Eventualni produžni kablovi za napajanje moraju imati prikladni promjer i u svakom slučaju nikad manji od promjera kabela za napajanje uređaja.
- Uvijek se obavezno mora spojiti stroj na uzemljenje upotrebom sprovodnika žuto-zelene boje kabela za napajanje, označenog sa etiketom (⏚), dok ostala dva sprovodnika moraju biti spojeni na fazu i

neutralni vod električne energije.

4. RAD TIJEKOM PUNJENJA

Napomena: prije počimanja sa punjenjem, provjeriti da kapacitet baterije (Ah) koja se puni nije niži od kapaciteta navedenog na pločici sa podacima punjača baterije (Cmin). Izršiti upute pažljivo slijedeći niže navedeni redoslijed.

4.1 PRIPREMA BATERIJE

Ako je baterija koja se uni vrste WET, učiniti slijedeće:

- Ukloniti čepove baterije (ako su prisutni) tako da plinoviti koji nastaju prilikom punjenja mogu izaći. Provjeriti da razina elektrolita prekriva ploče baterije; ako ploče baterije nisu prekrivene elektrolitom, dodati destilirane vode dok ploče nisu prekrivene za 5 – 10 mm.



POZORI TIJEKOM OVE RADNJE POTREBAN JE MAKSIMALNI OPREZ JER JE ELEKTROLIT VRLO KOROZIVNA KISELINA.

4.2 SPAJANJE PUNJAČA AKUMULATORA NA AKUMULATOR

- Provjerite je li kabel za napajanje iskopčan iz strujne utičnice.
- Za modele s više napona punjenja, postavite preklopnik ili komutator na odabranu vrijednost napona punjenja. Ako nema preklopnika ili komutatora, spojite kabel sa crvenom hvataljkom za punjenje (simbol +) na odgovarajuću stezaljku na punjaču akumulatora odnosno na odabranu vrijednost napona punjenja.
- Spojite klijesta za punjenje crne boje na pozitivnu stezaljku akumulatora (simbol +). Ako nije moguće raspoznati simbole, ne zaboravite da je pozitivna stezaljka ona koja nije spojena na šasiju vozila.
- Spojite hvataljku za punjenje crne boje na šasiju vozila, daleko od akumulatora i od cijevi za gorivo.
NAPOMENA: ako akumulator nije postavljen u vozilo, izvršiti spajanje izravno na negativnu stezaljku akumulatora (simbol -).

4.3 ISTOVREMENO PUNJENJE VIŠE BATERIJA

POZOR: ne smiju se puniti baterije sa različitim kapacitetom, razinom punjenosti i vrstom. Kada se treba puniti više baterija istovremeno, izvršiti „serijske“ ili „paralelne“ spojeve: serijsko

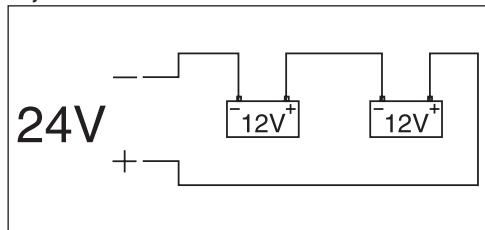

paralelno

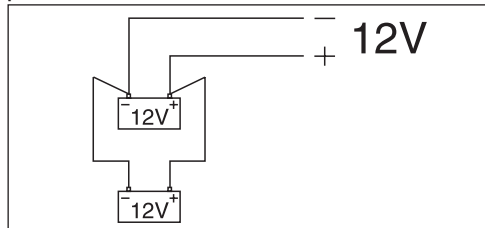

„Paralelni“ spoj zahtjeva da baterije imaju isti nominalni napon (Volt), koji odgovara naponu na izlazu punjača baterije i da je zbroj vrijednosti Ah unutar vrijednosti punjenja punjača baterije.

„Serijski“ spoj zahtjeva da baterije imaju isti kapacitet (Ah) i da je zbroj nominalnih napona svih baterija odgovara nominalnom naponu na izlazu iz punjača baterije.

4.4 KRAJ PUNJENJA

- Isključiti napajanje prema punjaču baterije izvlačenjem utikača kabla za napajanje iz utičnice električne mreže.
- Otključati hvataljku za punjenje crne boje sa šasije vozila ili sa negativnog pritezača baterije (simbol -).
- Otključati hvataljku za punjenje crvene boje sa pozitivnog pritezača baterije (simbol +).
- Odložiti punjač baterije na suho mjesto.
- Začepiti čelije baterije sa prikladnim čepovima (ako su prisutni).

5. RAD PRILIKOM PALJENJA

POZOR: prije početka rada pažljivo slijedite upozorenja proizvođača vozila!

- Morate zaštititi linija napajanja s osiguračima ili automatskim sklopkama čije se vrijednosti moraju poklopiti s vrijednostima navedenim na pločici s podacima sa simbolom ().
- Za lakše paljenje, prethodno izvršite brzo punjenje od 10-15 minuta, sa punjačem akumulatora potavljenim u položaj punjenja, a NE paljenja.
- Ako se vozilo ne upali, pričekajte nekoliko trenutaka i ponovite postupak brzog punjenja. Nemojte dalje insistirati ukoliko se motor vozila ne pali: to bi ozbiljno moglo oštetiti akumulator ili čak i električni sustav vozila.

5.1 SPAJANJE PUNJAČA AKUMULATORA S AKUMULATOROM

- Prije paljenja vozila provjerite da li se vrijednost nazivnog napona akumulatora i vrijednost postavljena na punjaču akumulatora podudaraju.
- Provjerite je li akumulator ispravno spojen na stezaljke (+ i -), jesu li spojevi prema akumulatoru ispravni i je li akumulator u dobrom stanju (da nije sulfatiran ili u kvaru).
- Nikako se ne smije vršiti paljenje vozila ako akumulatori nisu spojeni na odgovarajuće stezaljke; prisutnost akumulatora je ključna za uklanjanje eventualnih prekomjernih napona uslijed akumulacije energije unutar kabla za spajanje tijekom faza paljenja. **Nepoštovanje navedenih uputa može dovesti do oštećenja elektronike vozila.**

5.2 PALJENJE

- Za odabir ove funkcije, vidi ilustraciju “PALJENJE”.

5.3 KRAJ PALJENJA

- Izvući utikač kabla za napajanje iz utičnice mreže napajanja.
- Otključati hvataljku za punjenje crne boje sa negativne stezaljke akumulatora (simbol -) i hvataljku crvene boje sa pozitivne stezaljke akumulatora (simbol +).
- Odložite punjač akumulatora na suho mjesto.

6. ZAŠTITE PUNJAČA AKUMULATORA

Punjač akumulatora se sam štiti u slučaju:

- preopterećenja (prekomjerni dotok struje prema akumulatoru).
 - kratkog spoja (hvataljke za punjenje stavljene jedna s drugom u kontakt).
 - zamjena polova na stezaljkama akumulatora.
- Kod uređaja opremljenim osiguračima obvezno u trenutku zamjene treba koristiti iste rezervne dijelove koji imaju iste vrijednosti nazivne struje.



PAŽNJA: Ukoliko zamijenite osigurač s vrijednostima struje koje se razlikuju od onih navedenih na pločici, osobe i predmeti bi mogli pretrpjeti štetu. Iz istog razloga strogo morate izbjegavati zamijeniti osigurač s mostovima od bakra ili drugog materijala. Zamjenu osigurača uvijek treba vršiti kada je kabel za napajanje ISKOPČAN iz električne mreže. Pazite prilikom zamjene trakastog osigurača, ukoliko postoji, i čvrsto pritegnite matice za fiksiranje.

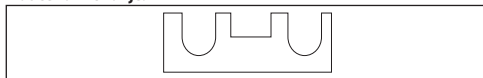

7. KORISNI SAVJETI

- Očistiti pozitivnu i negativnu stezaljku od mogućih okorjelih naslaga oksida kako bi se zajamčio ispravan kontakt hvataljki.
- Ako je akumulator na kojem namjeravate uporabiti punjač akumulatora fiksno postavljen unutar vozila, pogledajte i Priručnik s uputama za uporabu odnosno održavanje vozila u odjeljku “ELEKTRIČNI SUSTAV” ili “SERVISIRANJE”.



ĮSPĖJIMAS: PRIEŠ NAUDOJANT AKUMULIATORIAUS ĮKROVIKLĮ, ATIDŽIAI PERSKAITYTI INSTRUKCIJŲ VADOVĄ!

1. BENDRIEJI SAUGOS REIKALAVIMAI EKSPLOATAVIMUI



- Vengti kontakto su akumulatoriaus rūgštimi. Apsitaškymo ar kitokio kontakto su rūgštimi atveju, nedelsiant praskalauti pažeistą kūno dalį švariu vandeniu. Tęsti skalavimus pakol atvyks medikas.



- Įkrovimo metu baterijos išskiria sprogstančias dujas, vengti liepsnos ar kibirkščių susidarymo. **NERŪKYTI.**
- Įkrovinėti baterijas gerai vėdinamoje vietoje.



- Apsaugoti akis. Dirbant su švino rūgšties akumulatoriais visada naudotis apsauginiais akiniais.



- Dėvėti tinkamą aprangą. Nedėvėti plačių rūbų arba papuošalų, kurie galėtų įspainioti į judančias detales. Darbo metu patariama naudoti apsauginius elektriška izoliuotus drabužius bei nuo slydimo apsaugančią avalynę. Ilgų plaukų atveju dėvėti atitinkamą galvos apdangalą.



- Patyrimo neturintys asmenys, prieš naudodami prietaisą, turi būti tinkamai apmokyti.
- Vaikams nuo 8 metų amžiaus ir asmenims su ribotais fizinais, jusliniais arba protiniais gebėjimais arba asmenims, neturintiems pakankamai patirties ir žinių, šį įrenginį leidžiama naudoti tik prižiūrint kitam asmeniui arba jei jie buvo apmokyti kaip saugiai naudotis įrenginiu ir supranta apie galimus pavojus.
- Vaikams žaisti su įrenginiu draudžiama.
- Vaikams atlikti valymo ir naudotojų skirtus techninės priežiūros darbus, jei neprižiūri kitas asmuo, draudžiama.
- Naudoti baterijų įkroviklį tik uždaroje patalpoje ir įsitikinti, kad jos yra gerai vėdinamos: **NENAUDOTI PRIETAISO LYJANT AR SNINGANT.**
- Prieš sujungiant ar atjungiant įkrovimo laidus nuo baterijų, atjungti maitinimo laidą iš tinklo.
- Nejungti gnybtų prie baterijos, baterijų įkrovimo metu.
- Jokiais būdais nenaudoti baterijų įkroviklio automobilio ar kapoto viduje.
- Pakeisti maitinimo laidą tik originaliu laidu.
- Jei maitinimo kabelis yra pažeistas, gamintojas arba jo įgaliotas techninio aptarnavimo centras turi jį pakeisti nauju, bet kokių atveju šį darbą privalo atlikti tik panašios kvalifikacijos asmuo, tokiu būdu bus išvengta bet kokios rizikos.
- Nenaudoti baterijų įkroviklio neįkraunamoms baterijoms.
- Patikrinti, ar disponuojama maitinimo įtampa atitinka įtampą, nurodytą baterijų įkroviklio duomenų lentelėje.
- Siekiant nepažeisti transporto priemonių elektronikos, kruopščiai laikytis transporto priemonės arba naudojamo akumulatoriaus gamintojų nurodymų.
- Šis baterijų įkroviklis yra sudarytas iš dalių, tokių kaip jungikliai arba relės, galinčių uždegti elektros lankus arba įžeibti žiežirbas; todėl, jei yra naudojami techninės dirbtuvės ar panašioje aplinkoje, baterijų įkroviklis turi būti laikomas tam tikslui pritaikytoje patalpoje ar saugykloje.
- Bet kokia priežiūra ar taisymas, vykdomi baterijų įkroviklio viduje, turi būti atliekami tik specializuoto personalo.
- **DĖMESIO: VISADA IŠTRAUKTI MAITINIMO LAIDĄ IŠ TINKLO PRIEŠ VYKDYANT BET KOKIUS, KAD IR PAPRASCIAUSIUS, BATERIJŲ ĮKROVIKLIO PRIEŽIŪROS DARBUS, PAVOJINGAI!**
- Akumulatoriaus įkroviklis yra apsaugotas nuo netiesioginių

kontaktų įžeminimo laidininko pagalba, laikantis reikalavimų I klasės įrangai. Patikrinti, ar lizde yra numatytas apsauginis sujungimas su žeme.

- Modeliuose, kuriuose tai nėra numatyta, prijungti atitinkamo galingumo (ne žemesnio) kištukus prie lydziojo saugiklio, kurio vertė yra nurodyta duomenų lentelėje.



- A klasės įranga:

Šis akumuliatorių įkroviklis atitinka standartinius techninius reikalavimus gaminiui, skirtam naudoti pramoninėje aplinkoje profesionaliems tikslams. Nėra garantuojamas jo elektromagnetinis suderinamumas gyvenamosiose patalpose ir pastatuose, kurie yra tiesiogiai prijungti prie žemos įtamos elektros tiekimo tinklo, skirto buitiniam naudojimui.

2. BENDRAS APRAŠYMAS

Akumuliatorių įkroviklis yra skirtas švino akumuliatorių WET, EFB, GEL, AGM, + (Ca) ir ličio baterijų (Li), naudojamų variklinėse (varomose benzinu ir dyzeliu) ir elektrinėse transporto priemonėse - automobiliuose, motocikluose, vandens transporto priemonėse ir t.t., įkrovimui. Jis tinka 12V, 24V akumuliatorių įkrovimui; yra numatytas ir paleidimo režimas (tik variklinėse transporto priemonėse, varomoms benzinu ir dyzeliu). Įkraunami akumulatoriai pagal disponuojamą išėjimo įtampą: 12V / 6 elementai; 24V / 12 elementai.

3. ĮDIEGIMAS PASIRUŠIMAS

- Išpakuoti akumulatoriaus įkroviklį, atlikti atskirų pakuotėje tiekiamų detalių montavimo darbus.
- Modeliai su vežimėliais turi būti įdiegiami vertikaloje padėtyje.

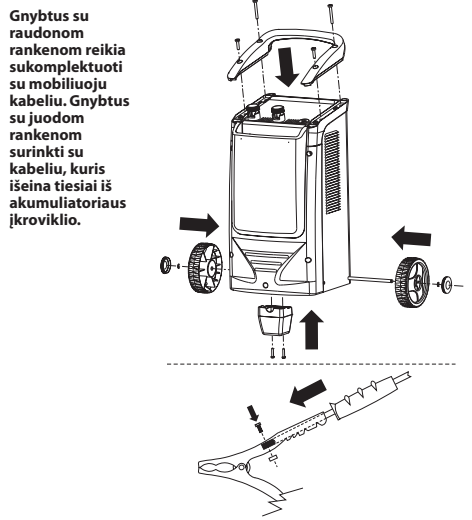

3.1 AKUMULIATORIŲ ĮKROVIKLIO PASTATYMAS

Eksploatavimo metu akumuliatorių įkroviklį pastatyti stabiliai bei patikrinti, ar nėra kliūčių oro praejimui pro specialias vėdinimo angas taip užtikrinant pakankamą ventilaciją.

3.2 PRIJUNGIMAS PRIE ELEKTROS TINKLO

- Akumuliatorių įkroviklis turi būti prijungtas tik prie elektros energijos tiekimo sistemos su neutraliu laidininku, prijungtu prie žemės.
- Patikrinti, ar elektros tiekimo tinklo įtampa atitinka akumulatoriaus įkroviklio darbinę įtampą, nurodytą duomenų lentelėje.
- Elektros tiekimo linija turėtų būti aprūpinta saugos sistemomis, tokiomis kaip lydieji saugikliai arba automatiniai grandinės pertraukikliai, kurių pakaktų maksimaliai įrenginio srovės absorbcijai.
- Prijungimas prie elektros tinklo turėtų būti atliekamas naudojant specialų maitinimo kabelį.
- Galimi maitinimo kabelio gigtuvai turi būti tinkamo skersmens, jis niekada negali būti mažesnis už įrenginio maitinimo kabelio skersmenį.
- Įrenginį visada privaloma prijungti prie žemės tam naudojant

maitinimo kabelio geltonos-žalios spalvos laidininką, pažymėtą etikele (↓), nuo tarpu kiti du laidininkai turi būti prijungiami prie elektros energijos paskirstymo tinklo fazės ir neutralaus laidininko.

4. DARBAS ĮKROVIKLO REŽIME

SVARBU: Prieš pradėdami įkrovimą, patikrinti, ar ketinamo įkrauti akumuliatoriaus talpa (Ah) nėra mažesnė už vertę, nurodytą akumuliatorių įkroviklių duomenų lentelėje (Cmin). Atlikti sujungimus kruopščiai laikantis žemiau nurodytos tvarkos.

4.1 AKUMULIATORIAUS PARUOŠIMAS

Jei įkraunamas akumuliatorius yra WET tipo, atlikti šiuos veiksmus:

- Nuimti akumuliatoriaus kamščius (jei yra), tokiu būdu įkrovimo metu susidariusios dujos galės išeiti. Įsitikinti, ar elektrolito lygis dengia akumuliatoriaus plokštes; jei taip nėra, papildyti distiliuoto vandens tiek, kad jos būtų apsemtos 5 – 10 mm.



DĖMESIO! ATKREIPTI YPATINGĄ DĖMESĮ ATLIKANT ŠIĄ OPERACIJĄ, NES ELEKTROLITAS YRA ITIN KOROZINĖ RUGŠTIS.

4.2 SUJUNGIMAS AKUMULIATORIŲ ĮKROVIKLIS/AKUMULIATORIUS

- Patikrinti, ar maitinimo kabelis yra ištrauktas iš elektros tinklo lizdo.
 - Modeliams su keliomis įkrovimo įtampomis, perjungiklį arba komutatorių nustatyti ties pasirinkta įkrovimo įtampa. Jei perjungiklio arba komutatoriaus nėra, kabelį su raudonais įkrovimo gnybtais (simbolis +) tinkamai prijungti prie specialaus akumuliatoriaus įkroviklio terminalo ties pasirinkta įkrovimo įtampa.
 - Prijungti raudonos spalvos įkrovimo gnybtą prie teigiamo akumuliatoriaus gnybto (simbolis +). Jei simbolį neįmanoma atpažinti, atminti, kad teigiamas gnybtas yra tas, kuris nėra prijungtas prie automobilio važiuoklės.
 - Prijungti juodos spalvos įkrovimo gnybtą prie automobilio važiuoklės, toliau nuo akumuliatoriaus ir nuo degalų tiekimo sistemos.
- PASTABA:** jei akumuliatorius nėra įmontuotas automobilijje, prisijungti tiesiogiai prie neigiamo akumuliatoriaus gnybto (simbolis -).

4.3 VIENALAIKIS KELETO AKUMULIATORIŲ ĮKROVIMAS

DĖMESIO: nebandykite įkrauti akumuliatorių, kurių talpa, išsikrovimo lygis ar tipas skiriasi tarpusavyje. Esant reikalui įkrauti keletą akumuliatorių tuo pačiu metu, juos galima sujungti nuosekliai arba lygiagrečiai:

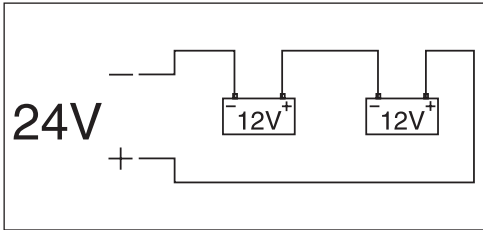

lygiagrečiai

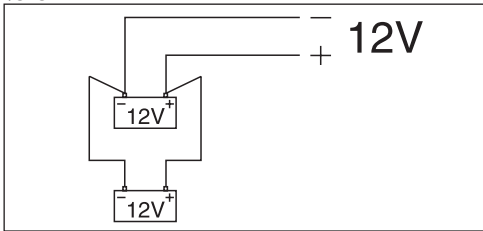

Lygiagrečiam sujungimui reikia, kad visi akumuliatoriai turėtų tokią pat vardinę įtampą (Volt), kuri atitiktų akumuliatorių įkroviklio išėjimo įtampą ir kad Ah suma išliktų akumuliatorių įkroviklio diapazono ribose.

Nuoseklajam sujungimui reikia, kad visi akumuliatoriai būtų tokios pat talpos (Ah) ir kad visų akumuliatorių vardinį įtampų suma atitiktų akumuliatorių įkroviklio išėjimo įtampą.

4.4 ĮKROVIMO PABAIGA

- Atjungti akumuliatorių įkroviklio maitinimą ištraukiant maitinimo kabelio kištuką iš elektros tinklo lizdo.
- Atjungti juodos spalvos įkrovimo gnybtą nuo transporto priemonės važiuoklės arba nuo neigiamo akumuliatoriaus gnybto (simbolis -).
- Atjungti raudonos spalvos įkrovimo gnybtą nuo teigiamo

akumuliatoriaus gnybto (simbolis +).

- Padėti akumuliatoriaus įkroviklį į sausą vietą.
- Uždenkti akumuliatoriaus elementus specialiais kamščiais (jei yra).

5. EKSPLOATAVIMAS PALEIDŽIANT

DĖMESIO: prieš pradėdami, atidžiai peržiūrėti transporto priemonių gamintojų nurodymus!

- Užtikrinti, kad maitinimo linija būtų apsaugota lydziaisiais saugikliais arba automatiniais perjungikliais, kurių atitinkami dydžiai yra nurodyti duomenų lentelėje ties simboliu (—|—|—).
- Siekiant palengvinti paleidimą, pirmiausia atlikti greitą 10-15 minučių įkrovimą; akumuliatorių įkroviklis turi būti įkrovimo, o NE paleidiklio padėtyje.
- Jei transporto priemonė neužsiveda, palaukti keletą minučių ir vėl pakartoti greitojo įkrovimo operaciją. Jei transporto priemonės variklis neužsiveda, primygtinai nebandyti iš naujo, nes tai galėtų rimtai pažeisti patį akumuliatorių ar net sugadinti transporto priemonės elektros instaliaciją.

5.1 SUJUNGIMAS AKUMULIATORIŲ ĮKROVIKLIS/AKUMULIATORIUS

- Prieš pradėdami užvedinėti transporto priemonę, įsitikinti, ar akumuliatoriaus vardinės įtampos vertė atitinka akumuliatorių įkroviklyje nustatytą dydį.
- Įsitikinti, ar akumuliatoriaus yra tinkamai sujungtas su atitinkamais gnybtais (+ ir -), ar sujungimai su akumuliatorių yra taisyklingi ir ar jo stovis yra geras (nėra apsinėšęs sulfatais ir nėra sugedęs).
- Jokiais būdais nepaleidinėti transporto priemonių, kai akumuliatoriai yra atjungti nuo atitinkamų gnybtų; akumuliatorių buvimas yra labai svarbus galimų viršįtampių pašalinimui dėl energijos poveikio, nes ji gali susikaupti sujungimo laiduose paleidimo metu. **Šių nurodymų nesilaikymas gali sugadinti transporto priemonės elektroniką.**

5.2 PALEIDIMAS

- Norint pasirinkti šią funkciją, žiūrėti paveikslėlį „PALEIDIMAS“.

5.3 PALEIDIMO PABAIGA

- Ištraukti maitinimo kabelio kištuką iš elektros energijos tinklo lizdo.
- Atjungti juodos spalvos įkrovimo gnybtą nuo automobilio važiuoklės arba nuo neigiamo akumuliatoriaus gnybto (simbolis -) ir raudonos spalvos įkrovimo gnybtą nuo teigiamo akumuliatoriaus gnybto (simbolis +).
- Padėti akumuliatoriaus įkroviklį į sausą vietą.

6. AKUMULIATORIAUS ĮKROVIKLIO SAUGOS ĮTAISAI

Akumuliatoriaus įkroviklis yra apsaugotas nuo:

- Perkrovo (į akumuliatorių tiekama per didelė srovė).
- Trumpojo sujungimo (įkrovimo gnybtai liečiasi tarpusavyje).
- Poliškumo sukietimo ant akumuliatoriaus gnybtų.

Įrenginiuose, aprūpintuose lydziaisiais saugikliais, jų keitimui atveju privaloma naudoti tokio pat nominaliojo srovės stiprumo detales.



DĖMESIO: Lydziojo saugiklio pakeitimas kitu, kurio srovės stiprumo vertė yra kitokia, nėra nurodyta duomenų lentelėje, gali padaryti žalos asmenims ar daiktams. Dėl tokios pat priežasties, absoliučiai vengti lydziojo saugiklio pakeitimo variniais ar kitokios medžiagos tiltais. Lydziojo saugiklio pakeitimo operacija turi būti visada atliekama tik ATJUNGUS maitinimo kabelį nuo elektros tinklo. Juostinio lydziojo saugiklio atveju pakeitimo metu atkreipti ypatingą dėmesį bei tvirtai užveržti pritvirtinimo varžles.

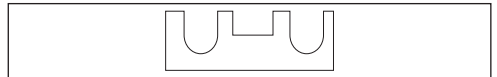

7. NAUDINGI PATAIMAI

- Nuvalyti galimas oksidacijos apnašas nuo teigiamo ir neigiamo gnybto, tokiu būdu bus užtikrintas neprikaištingas gnybtų kontaktas.
- Jei akumuliatorius, su kuriuo norima naudoti šį įkroviklį, yra nuolatnai instaliuotas transporto priemonėje, peržiūrėti ir transporto priemonės instrukcijų ir (arba) techninės priežiūros vadovo skyryje „ELEKTROS INSTALIACIJA“ arba „TECHNINĖ PRIEŽIŪRA“.



TÄHELEPANU: ENNE AKULAADIJA KASUTAMIST LUGEGE JUHISED HOOLIKALT LÄBI!

1. ÜLDISED HOIATUSED KASUTAMISEKS



- Vältige kokkupuudet akus oleva happega. Juhul kui hapet akust välja pritsib või kui kasutaja sellega kokku puutub, tuleb happega saastunud kohta viivitamatult puhta veega loputada. Loputamist tuleb jätkata arsti saabumiseni.



- Laadimise ajal akud eraldavad plahvatusohtlike gaase, vältige leekide ja sädemete teket. ÄRGE SUHTSETAGE.
- Asetage laetavad akud hästi ventileeritud ruumi.



- Kaitske silmi. Kandke plii-hape akumulaatoritega töötamisel alati kaitsesprille.



- Kandke sobilikke tööriideid. Ärge kandke laiu rõivaid ega ehteid, mis võivad seadme liikuvate osade külge kinni jääda. Töö kestel on soovitatav kanda elektrisolatsiooniga kaitseserietust ja libisemisvastase tallaga jalanõusid. Pikad juuksed tuleb sobiliku mütsi alla kokku panna.



- Vastavat kogemust mitteomavaid isikuid tuleb enne seadme kasutamist selle suhtes instrueerida.
- Seadet tohivad kasutada üle 8 aastased lapsed ja väikese füüsiliste, sensoriaalsete või vaimsete puuetega inimesed, samuti kogemusteta ja vajalike teadmisteta inimesed, järelevalve all või peale seadme ohutut kasutamist ja sellest tulenevaid riske puudutava väljaõppe saamist.
- Lastel on keelatud seadmega mängida.
- Puhastus ja hooldus peavad olema läbi viidud kasutaja poolt, kuid mitte laste poolt ilma järelevalveta.
- Kasutage akulaadijat ainult siseruumides ja kindlustage, et töotate hästi ventileeritud keskkonnas: ÄRGE JÄTKE LUME VÕI VIHMA KÄTTE.
- Enne aku laadimiskaablite ühendamist või lahutamist, eemaldage voolujuhe vooluvõrgust.
- Ega ühendage ega lahutage klemme akuga akulaadija töötamise ajal.
- Ärge kasutage mitte mingil juhul akulaadijat autokabiinis või -kapotis.
- Vahetage voolujuhe välja ainult originaaljuhtmega.
- Mis tahes riski vältimiseks tuleb toitekaabel, juhul, kui see on kahjustada saanud valmistajate või tema tehnilise abi teenuse poolt, igal juhul vastava ettevalmistuse saanud isiku poolt, välja vahetada.
- Ärge kasutage akulaadijat mitte laaditavate akude laadimiseks.
- Kontrollige, et käsutuses olev voolupinge vastab akulaadija andmeplaadil näidatud andmetele.
- Et sõidukite elektroonikaseadmeid mitte kahjustada, tuleb hoolikalt järgida sõidukite või kasutatavate akude valmistaja poolseid nõudeid.
- Akulaadija sisaldab osasid, nagu lülitid või relee, mis võivad esile kutsuda pritsmeid või sädemeid. Juhul, kui kasutate seadet garaazhis või sarnases keskkonnas, seadke akulaadija eesmärgiks sobivasse ruumi või kaitsesse.
- Akulaadija sisemuses tohib teostada parandus ja hooldus töid ainult vastava kvalifikatsiooniga personal.
- TÄHELEPANU: ENNE AKULAADIJA MISTAHES VIISIL HOOLDAMIST LAHUTAGE SEE TOITEALLIKAST. OHT!
- Akulaadija on kaudsete kontaktid eest kaitstud maanduskaabliga, nagu määratud I klassi aparaatidele. Kontrollige, et pesa on

kaitsemaandatud.

- Mudelitel, millel see puudub, ühendage juurde sobivad pistikud, mille koormus ei ole väiksem sulavkaitsete andmeplaadil ära toodust väärtusest.



- A klassi seadmed:

See akulaadija on vastavuses toote tehniliste standardnõuetele, kasutamiseks professionaalsel eesmärgil industriaalses keskkonnas. Pole tagatud vastavus elektromagnetilise ühilduvuse nõuetele olmehoonetes ja neis hoonetes, mis on otseselt ühendatud majapidamishooneid varustava madalpinge toitevõrguga.

2. ÜLDINE KIRJELDUS

Akulaadija on ette nähtud WET, EFB, GEL, AGM + (Ca) pliiakude ja mootor- (bensiin ja diisel) ning elektrisõidukites: autod, mootorsõidukid, mootorrattad, paadid jne kasutatavate Li liitiumakude laadimiseks. On võimalik laadida 12 ja 24 voldiseid akusid; on olemas ka käivitusrežiim (ainult bensiin- ja diiselmootoriga sõidukitele). Taaslaetavad akumulaatorid vastavalt saadaolevale väljundpingele: 12V / 6 elementi; 24V / 12 elementi.

3. PAIGALDUS

ETTEVALMISTUS

- Vabastage akulaadija pakendist, monteerige peale pakendis leiduvad lahised osad.
- Sõidutatavad mudelid paigaldatakse vertikaalselt.

Liikuva kaabliga ühendatud punaste käepidemetega klamber. Otse akulaadijast väljuva kaabliga ühendatud mustade käepidemetega klamber.

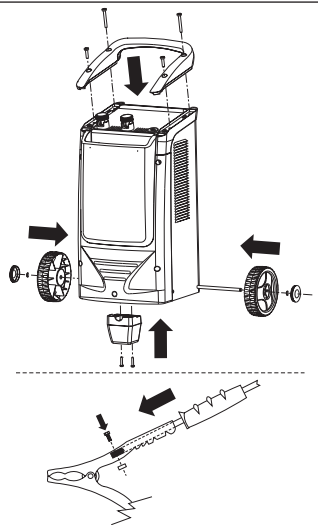

3.1 AKULAADIJA PAIGUTUS

Funktsioneerimise ajal asetage akulaadija stabiilselt paigale ja veenduge, et poleks takistatud õhuvahetus läbi vastavate avade, tagamaks sel moel piisava ventilatsiooni.

3.2 ÜHENDAMINE ELEKTRIVÕRGUGA

- Akulaadija peab olema ühendatud üksnes maandatud neutraalse juhiga toitesüsteemiga.
- Kontrollige, et elektrivõrgupinge vastaks andmeplaadil ära toodud akulaadija tööpingele.
- Toetulin peab olema varustatud kaitsesüsteemidega nagu sulavkaitses või automaatlülid, mis suudavad taluda seadme poolset maksimaalset neeldumist.
- Ühendamine elektrivõrguga tuleb sooritada vastava toitekaabli abil.
- Võimalikud toitekaabli pikendused peavad omama sobivat sektsiooni, mis ei tohi igal juhul olla väiksem seadme toitekaabli omast.
- Alati on nõutav seadme ühendamine maandusega, kasutades kollast-rohelist värvi toitekaablit, mida eristab etikett (↓), samal ajal, kui ülejäänud kaks juhet ühendatakse elektrivõrgu faasi ja neutraaliga.

4. FUNKTSioneerimine LAADIMISE AJAL

NB: Enne, kui laadimist jätkate, veenduge, et selle aku maht (Ah),

mida kavatakse laadida poleks väiksem akulaadija andmeplaadil ära toodud (Cmin). Järgige hoolikalt instruksioone allpool ära toodud järjekorras.

4.1 AKU ETTEVALMISTAMINE

Kui laadimist vajav aku on WET tüüpi, toimige järgmiselt:

- Eemaldage akudelt korgid (kui on), nii et laadimise käigus tekitatavad gaasid pääseksid välja. Kontrollige, et elektrolüüdi tase kataks akuplaate; juhul, kui see nii pole, lisage destilleeritud vett, kuni plaadid on 5-10 mm sellega kaetud.



TÄHELEPANU! NIMETATUD OPERATSIOONI AJAL TULEB OLLA ERITI HOOLIKAS, SEST ELEKTROLÜÜT ON ÄÄRMISELT SÕBIV.

4.2 AKULAADIJA/AKU ÜHENDAMINE

- Kontrollige, et toitekaabel oleks võrgupesast lahti ühendatud.
- Rohkemate laengupingetega mudelite puhul paigutage ümbersuunamiseadme või kommutaator vastavalt eelnevalt valitud laengupingele. Ümbersuunamiseadme või kommutaatori puudumisel, ühendage punase laenguklambriga (sümbol +) kaabel akulaadija vastava klemmiga, tulenevalt eelnevalt valitud laengupingest.
- Ühendage punast värvi laadimisklamber aku positiivse klemmiga (sümbol +). Juhul, kui sümbolid ei eristu, pidage meeles, et positiivne klemm on see, mis pole masina kerega ühendatud.
- Ühendage musta värvi laadimisklamber masina kerega, eemale akust ja kütusejhtmest.
MÄRKUS: kui akul pole masinas paigaldatud, sooritage ühendus otse aku negatiivse klemmiga (sümbol -).

4.3 MITME AKU ÜHEAEGNE LAADIMINE

TÄHELEPANU: ärge laadige omavahel erineva mahu, tühjenemise ja tüpoloogiga akusid. Kui tuleb samaaegselt laadida mitut akut, on võimalik kasutada "järjestikuseid" või "paralleelseid" ühendusi: järjestikune

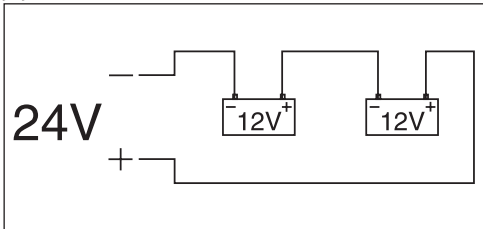

paralleln

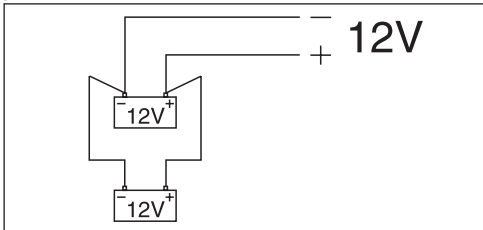

"Paralleln" ühendamine nõuab, et akud oleksid ühesuguse nominaalpingega (volt), mis vastab akulaadijast väljuvale pingele, ja et Ah-de summa jääks akulaadija laadimisvahemikku.

"Järjestikku" ühendamine nõuab, et akudel oleks sama võimsus (Ah), ja et kõikide nominaalpingete summa vastaks akulaadijast väljuvale pingele.

4.4 LAADIMISE LÕPP

- Eemaldage akulaadijalt toide, võttes toitejuhtme pistiku elektrivõrgu pistikupesast välja.
- Võtke musta värvi laadimisklamber sõiduki kere küljest või aku negatiivse klemmi küljest lahti (sümbol -).
- Eemaldage punane laenguklamber aku positiivse klemmi küljest (sümbol +).
- Astage akulaadija tagasi kuiva kohta.
- Sulgege akuelemendid vastavate korkidega (kui on).

5. TÖÖ KÄIVITAMISEL

TÄHELEPANU: enne jätkamist tutvuge hoolikalt sõidukite valmistaja poolsete nõuetega!

- Kaitske toiteliini sulavkaitsmete või andmeplaadil sümboliga (

tähistatud väärtusele vastavate automaatlülitega.

- Käivitamise lihtsustamiseks sooritage eelnevalt üks 10-15 minutiline kiirlaadimine akulaadijaga laadimise ja MITTE käivitamise positsioonis.
- Kui sõiduk ei käivitu, oodake mõni minut ja korrake kiirlaadimisoperatsiooni. Kui sõiduki mootor ei käivitu, ärge edasi üritage; aku või koguni sõiduki elektriseadmistik võivad sel moel tõsiselt kahjustada saada.

5.1 AKULAADIJA/AKU ÜHENDAMINE

- Enne sõiduki käivitamisega alustamist veenduge, et aku pinge nominaalväärtus vastaks akulaadijasse seadistatud väärtusele.
- Veenduge, et aku oleks õigesti ühendatud vastavate klemmidega (+ ja -), ühendused aku suunas korrektselt sooritatud ja aku ise heas seisukorras (mitte sulfaatunud või riknenud).
- Mitte mingil juhul ärge käivitage sõidukit, mille akud on vastavate klemmidest küljest lahti; aku olemasolu on määrav vabanemaks võimalikust ülepingsest energiast mõjul, mis võib ühenduskaablitesse koguneda käivitusfaaside käigus. **Nimetatud nõuete eiramine võib kahjustada sõiduki elektroonikaseadmeid.**

5.2 KÄIVITAMINE

- Selle funktsiooni valimiseks vaadake illustratsiooni "KÄIVITAMINE".

5.3 KÄIVITAMISE LÕPP

- Eemaldage toitekaabli pistik toitevõrgu pistikupesast.
- Võtke musta värvi klamber aku negatiivse klemmi küljest (sümbol -) ja punane aku positiivse klemmi küljest (sümbol +) lahti.
- Astage akulaadija tagasi kuiva kohta.

6. AKULAADIJA KAITSMED

Akulaadija kaitsab end ise juhul kui:

- Ülekoormus (liigne voolu väljutamine aku suunas).
- Lühis (omavahel kokku puutuvad laadimisklambrid).
- Pöördpolaarsus aku klemmidel.

Sulavkaitsmetega varustatud seadmete puhul on osade väljavahetamise korral kohustuslik kasutada analoogseid, sama voolu nominaalväärtusega varuosi.



TÄHELEPANU: Sulavkaitsme asendamine andmeplaadil ära toodud väärtustest teistsuguste vooluväärtustega võib põhjustada kahjustusi nii inimestele kui esemetele. Samal põhjusel tuleb igati hoiduda sulavkaitsmete väljavahetamisest vasest või muust materjalist sildade vastu. Sulavkaitsmete vahetust peab alati toimuma JÄRGUST VÄLJAS toitekaabliga. Olge hoolikas lint sulavkaitsme väljavahetamisel, keerake fikseerimiskruvid tihedalt kinni.



7. KASULIKUD SOOVITUSED

- Puhastage positiivset ja negatiivset klemmi võimalikult kogunenud oksidist, et tagada klambrite hea kontakt.
- Kui aku, mille peal soovitate akulaadijat kasutada asub püsivalt sõiduki sees, konsulteerige sõiduki kasutus- ja/või hooldusjuhendit peatükkides "ELEKTRISÜSTEEM" või "HOOLDUS".



UZMANĪBU: PIRMS AKUMULATORU LĀDĒTĀJA IZMANTOŠANAS UZMANĪGI IZLASIET ROKASGRĀMATU!

1. VISPĀRĒJIE DROŠĪBAS NOTEIKUMI LIETOŠANAS LAIKĀ



- Izvairieties no nonākšanas saskarē ar akumulatora skābi. Gadījumā, ja uz jūsu ādas nokļūst skābe vai ja jūs nonākat saskarē ar skābi, nekavējoties noskalojiet iesaistīto ķermeņa daļu ar tīru ūdeni. Turpiniet skalot, līdz ierodas ārsts.



- Uzlādēšanas laikā akumulatori izlaiž sprādziennedrošas gāzes, novērsiet liesmas un dzirkstelju veidošanos. NESMĒKĒT.
- Novietojiet lādējamus akumulatorus vēdināmā vietā.



- Aizsargājiet acis. Strādājot ar svina akumulatoriem ar skābi vienmēr valkājiet aizsargbrilles.



- Ģērbieties atbilstoši veidā. Nevelciet platu apģērbu vai rotaslietas, kuras var iepīties kustīgajās daļās. Darba laikā tiek rekomendēts lietot aizsargtērpus ar elektrisko izolāciju, kā arī zābakus ar neslidošu zoli. Gadījumā, ja jums ir gari mati, velciet galvassegu.



- Pirms ierīces lietošanas nepietiekoši kvalificētām personām jāiziet instruktāžā.
- Šo ierīci drīkst izmantot bērni, sākot no 8 gadu vecuma, kā arī personas ar ierobežotām fiziskām, jutiekiskām vai garīgām spējām un personas, kurām trūkst pieredzes un/vai zināšanu, ja viņus uzrauga cita persona vai, ja viņi ir instrueti par ierīces drošu izmantošanu un par riskiem, kas ar to saistīti.
- Bērni nedrīkst rotāties ar ierīci.
- Bērni bez uzraudzības nedrīkst veikt tīrīšanas vai paredzētās tehniskās apkopes operācijas.
- Lietojiet akumulatoru lādētāju tikai iekšējās un ārējās, vai tās ir labi vēdināmas. NETURIET ZEM LIETUS VAI SNIEGA.
- Pirms akumulatora lādētāja vadu pieslēgšanas vai atslēgšanas no akumulatora atslēdziet barošanas vadu no tīkla.
- Akumulatoru lādētāja darbības laikā nesavienojiet spaiļus ar akumulatoru un neatvienojiet tās.
- Nekādā gadījumā nelietojiet akumulatoru lādētāju automobiļa vai pārsega iekšā.
- Nomainiet barošanas vadu tikai pret oriģinālo vadu.
- Ja barošanas vads ir bojāts, tā nomaina jāuztūkst ražotāja vai servisa centra speciālistam vai personai ar līdzīgu kvalifikāciju, lai izvairītos no jebkādiem riskiem.
- Nelietojiet akumulatoru lādētāju, lai uzlādētu baterijas, kuras nav paredzētas atkārtotai uzlādēšanai.
- Pārbaudiet, vai esošais barošanas spriegums atbilst akumulatoru lādētāja tehniskajā apliecībā norādītajam spriegumam.
- Lai nesabojātu transportlīdzekļa elektroniku, rūpīgi ievērojiet transportlīdzekļa un akumulatoru ražotāja sniegtos norādījumus.
- Dažās šī akumulatora lādētāja daļās, piemēram, pārslēgi vai releji, var veidot elektriskos lokus vai dzirksteles, tāpēc ja ierīci izmanto autodarbnīcā vai līdzīgā vietā, akumulatoru lādētājs ir jānovieto tās izmantošanas mērķim atbilstošā vietā vai attiecīgajā futrālī.
- Akumulatoru lādētāja iekšpusē roņojumi vai tehnisko apkopi drīkst veikt tikai pieredzējušais personāls.
- UZMANĪBU: PIRMS JEBKURAS AKUMULATORU LĀDĒTĀJA VIENKĀRŠAS TEHNISKAS APKOPES OPERĀCIJAS VEIKŠANAS OBLIGĀTI IZSLĒDZIET BAROŠANAS VADU NO TĪKLA!
- Atbilstoši I klases aparāturai izvirzītajām prasībām, no netiešajiem kontaktiem akumulatoru lādētājs ir aizsargāts ar zemējuma vada palīdzību. Pārbaudiet, vai rozete ir aprīkota ar

iezemēšanas aizsargsavienojumu.

- Modeļos, kas ar to nav aprīkoti, pievienojiet kontaktdakšu ar piemērotu nominālu, kas nav mazāks par drošinātāja vērtību, kas norādīta tehnisko datu plāksnītē.



- A klases ierīce:

Šis akumulatoru lādētājs atbilst tehniskā standarta prasībām, kas attiecas uz rūpnieciskajā vidē un profesionālajai lietošanai paredzētajiem izstrādājumiem. Nav nodrošināta elektromagnētiskā saderība dzīvojamajās mājās, kā arī ēkās, kuras ir pa tiešo savienotas ar sadzīves zemsprieguma elektrotīklu.

2. VISPĀRĪGS APRAKSTS

Šis akumulatoru lādētājs ir paredzēts WET, EFB, GEL, AGM + (Ca) svina akumulatoru un Li litija akumulatoru lādēšanai, kurus izmanto motorizētajos transportlīdzekļos (ar benzīna vai dīzeļa dzinēju) un elektriskajos transportlīdzekļos: automašīnās, automobiļos, motociklos, laivās u.c. Ar to var uzlādēt akumulatorus ar 12 V un 24 V spriegumu; ir paredzēts arī iedarbināšanas režīms (tikai transportlīdzekļiem ar benzīna un dīzeļa dzinējiem).

Uzlādējamās baterijas un to izejas spriegums: 12 V / 6 elementi; 24 V / 12 elementi.

3. UZSTĀDĪŠANA SAGATAVOŠANA

- Izņemiet akumulatoru lādētāju no iepakojuma, samontējiet iepakojumā esošās atsevišķas sastāvdaļas.
- Pārveidotajam modeļam uzstāda vertikālā stāvoklī.

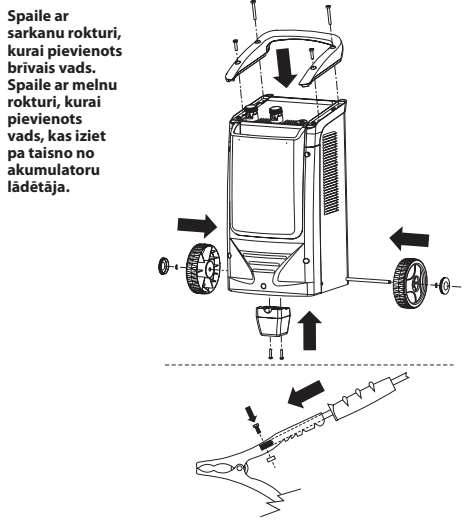

3.1 AKUMULATORU LĀDĒTĀJA IZVIETOJUMS

Darba laikā uzstādiet akumulatoru lādētāju stabilā stāvoklī un pārliecinieties, ka nav traucēta gaisa plūsma caur speciālām atverēm, lai nodrošinātu piemērotu ventilāciju.

3.2 PIEVIENOŠANA PIE ELEKTRĪBAS TĪKLA

- Akumulatoru lādētāju drīkst pieslēgt tikai pie tādas barošanas sistēmas, kurai neitrālais vads ir izņemts.
- Pārbaudiet, vai elektrotīkla spriegums atbilst akumulatoru lādētāja darba spriegumam, kas norādīts tehnisko datu plāksnītē.
- Barošanas līnijai jābūt aprīkoti ar aizsargsistēmām, tādām kā drošinātāji vai automātiskie slēdži, kas ir pietiekoši jaudīgi, lai izturētu ierīces maksimālo patērējamo strāvu.
- Ierīce jāsavieno ar elektrotīklu, izmantojot piemērotu barošanas vadu.
- Ja tiek izmantoti barošanas vada pagarinātāji, to šķērsgrizumiem jābūt piemērotam un nekādā gadījumā ne mazākam par ierīces barošanas vada šķērsgrizumu.
- Ierīci visu laiku jābūt izņemtai, izmantojot dzeltenī-zaļo barošanas kabeļa vadu, kas apzīmēts ar etiķeti (L), pārejot divus vadus savieno ar elektrības tīkla fāzi un neitrāli.

4. IZMANTOŠANA UZLĀDĒŠANAS REŽĪMĀ

IEVĒROJIET: Pirms uzlādēšanas pārbaudiet, vai uzlādējamā akumulatora kapacitāte (Ah) nav mazāka par vērtību, kas norādīta akumulatoru lādētāja tehnisko datu plāksnītē (Cmin). Izpildiet norādījumus, rūpīgi ievērojot zemāk izklāstīto kārtību.

4.1 AKUMULATORA SAGATAVOŠANA

Ja ir jāuzlādē WET tipa akumulators, rīkojieties šādi:

- Noņemiet akumulatora vāciņus (ja tie ir), lai gāzes, kas veidojas uzlādēšanas laikā, varētu iziet ārā. Pārbaudiet, vai elektrolīts pārkļā akumulatora plāksnes; ja tās ir atklātas, pievienojiet destilēto ūdeni līdz plāksnes ir iegremdētas 5–10 mm dziļumā.



UZMANĪBU! ESĪET ĪPAŠI UZMANĪGS ŠĪS OPERĀCIJAS VEIKŠANAS LAIKĀ, JO ELEKTROLĪTS IR ĻOTI KODĪGA SKĀBE.

4.2 AKUMULATORU LĀDĒTĀJA PIEVIENOŠANA

- Pārbaudiet, vai barošanas vads ir atvienots no elektrotīkla rozetes.
 - Modeļos, kuri atbalsta vairākus uzlādēšanas spriegumus, uzstādiet pārslēdzēju vai slēdzi pozīcijā, kas atbilst nepieciešamajam uzlādēšanas spriegumam. Ja pārslēdzēja vai slēdža nav, pieslēdziet kabeli ar sarkanu spaili (simbols +) pie akumulatoru lādētāja kontakta, kas atbilst nepieciešamajam uzlādēšanas spriegumam.
 - Savienojiet sarkano uzlādēšanas spaili ar akumulatora pozitīvo kontaktu (simbols +). Ja simbolus ir grūti atšķirt, atgādinām, ka pozitīvā spāile ir tā, kura nav savienota ar automašīnas šasiju.
 - Savienojiet melno uzlādēšanas spaili ar mašīnas šasiju, tālu no akumulatora un no degvielas caurules.
- PIEZĪME:** ja akumulators nav uzstādīts mašīnā, savienojiet to pa taisno ar akumulatora negatīvo spaili (simbols -).

4.3 VAIRĀKU AKUMULATORU VIENLAICĪGA UZLĀDĒŠANA

UZMANĪBU: neuzlādējiet akumulatorus, kuru kapacitāte, izlādēšanās pakāpe vai tips atšķiras. Ja ir nepieciešams vienlaicīgi uzlādēt vairākus akumulatorus, var izmantot "secīgo" vai "paralēlo" savienojumu:

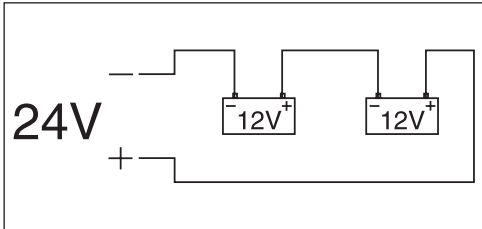

paralēli

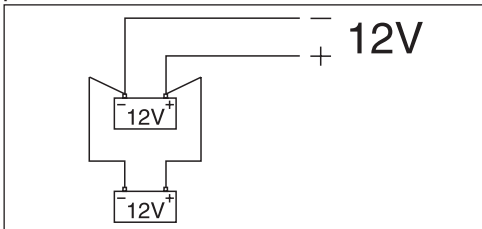

"Paralēlai" savienošanai ir nepieciešams, lai akumulatoriem būtu vienāds nominālais spriegums (volts), kas atbilst akumulatoru lādētāja izejas spriegumam, un, lai Ah kapacitātes vērtību summa iekļautos akumulatoru lādētāja uzlādēšanas diapazonā.

"Secīgai" savienošanai ir nepieciešams, lai akumulatoriem būtu vienāda kapacitāte (Ah) un, lai visu akumulatoru nominālo spriegumu summa atbilstu akumulatoru lādētāja izejas spriegumam.

4.4 UZLĀDĒŠANAS PABEIGŠANA

- Izslēdziet akumulatoru lādētāju, atvienojot barošanas vada kontaktakdas no elektrotīkla kontaktrozetes.
- Atvienojiet melno uzlādēšanas spaili no mašīnas šasijas vai no akumulatora negatīvā kontakta (simbols -).
- Atvienojiet sarkano uzlādēšanas spaili no akumulatora pozitīvā kontakta (simbols +).
- Novietojiet akumulatoru lādētāju sausā vietā.
- Aizveriet akumulatora elementus ar atbilstošiem vāciņiem (ja tie ir).

5. IZMANTOŠANA IEDARBINĀŠANAS REŽĪMĀ

UZMANĪBU: pirms turpināšanas uzmanīgi izlasiet transportlīdzekļa ražotāja brīdinājumus!

- Pārlicinieties, ka barošanas līnija ir aizsargāta ar drošinātājiem vai automātiskajiem slēdzīem, kuru nomināls atbilst attiecīgajai vērtībai, kas tehnisko datu plāksnītē apzīmēta ar simbolu ().
- Lai atvieglotu iedarbināšanu, vispirms veiciet 10-15 minūšu ātro uzlādēšanu, akumulatoru lādētājam esot uzlādēšanas un NEVIS iedarbināšanas stāvoklī.
- Ja transportlīdzeklis neizdodas iedarbināt, uzgaidiet dažas minūtes un atkārtoti veiciet ātro uzlādēšanu. Neturpiniet mēģinājumus, ja transportlīdzekļa dzinēju neizdodas iedarbināt; tas var nopietni sabojāt akumulatoru vai pat transportlīdzekļa elektroiekārtu.

5.1 AKUMULATORU LĀDĒTĀJA/AKUMULATORA SAVIENOŠANA

- Pirms transportlīdzekļa iedarbināšanas pārlicinieties, ka akumulatora nominālais spriegums atbilst akumulatoru lādētāja iestatītajai vērtībai.
- Pārlicinieties, ka akumulators ir labi savienots ar attiecīgajām spailēm (+ un -), ka savienojums ar akumulatoru ir pareizs un ka akumulators ir labā stāvoklī (nav pakļauts sulfatācijai un nav bojāts).
- Ir kategoriski aizliegts iedarbināt transportlīdzekļus, ja to akumulators ir atvienots no atbilstošām spailēm; akumulatora esamība ir ļoti svarīga iespējama pārsprieguma novēršanai, kas var rasties savienošanas vados iedarbināšanas laikā akumulētās enerģijas dēļ. **Šo norādījumu neievērošana var sabojāt transportlīdzekļa elektroniku.**

5.2 IEDARBINĀŠANA

- Lai izvēlētos šo funkciju, skatiet ilustrāciju "IEDARBINĀŠANA".

5.3 PĒC IEDARBINĀŠANAS

- Atvienojiet barošanas vada kontaktakdas no elektrotīkla kontaktrozetes.
- Atvienojiet melno uzlādēšanas spaili no akumulatora negatīvā kontakta (simbols -) un sarkano spaili no akumulatora pozitīvā kontakta (simbols +).
- Novietojiet akumulatoru lādētāju sausā vietā.

6. AKUMULATORU LĀDĒTĀJA AIZSARGIERĪCES

Akumulatoru lādētājs ir aizsargāts no:

- Pārslodzes (pārmērīgas strāvas padeves akumulatoram).
- Issavienojuma (lādētāja spaiļu kontakts).
- Akumulatora spaiļu polaritātes sajaukšanas.

Mainot drošinātājus ierīcēs, ar kurām tās ir aprīkotas, ir obligāti jāizmanto analogiski drošinātāji ar tādu pašu nominālo strāvu.



UZMANĪBU: Ja ir uzstādīti drošinātāji ar nominālo strāvu, kas atšķiras no plāksnītē norādītās, tas var izraisīt personu traumēšanu vai mantas bojājumu. Tāpēc ir kategoriski aizliegts drošinātāju vietā ievietot vara vai cita materiāla tiltslēgus. Drošinātāju maiņas laikā barošanas vadam vienmēr jābūt **ATVIENOTAM** no elektrības tīkla. Mainot lentes drošinātāju esiet uzmanīgs, ja tie ir, un cieši pievelciet nostiprinātājusgriežņus.



7. NODERĪGI PADOMI

- Tīriet negatīvo un pozitīvo kontaktu, lai uz tiem nebūtu oksīda un lai nodrošinātu labu kontaktu ar spailēm.
- Ja akumulatoru, kuru ir paredzēts uzlādēt ar šo akumulatoru lādētāju, nevar izņemt no transportlīdzekļa, skatiet arī transportlīdzekļa ekspluatācijas un/vai tehniskās apkopes rokasgrāmatas nodaļas "ELEKTROIEKĀRTA" vai "TEHNISKĀ APKOPE".



ВНИМАНИЕ: ПРЕДИ ДА ИЗПОЛВАТЕ ЗАРЯДНОТО УСТРОЙСТВО, ПРОЧЕТЕТЕ ВНИМАТЕЛНО РЪКОВОДСТВОТО С ИНСТРУКЦИИ!

1. ОБЩА БЕЗОПАСНОСТ ПРИ УПОТРЕБА



- Избягвайте контакт с киселината на акумулатора. В случай на изпръскване или на контакт с киселината, да се измие незабавно съответната част с чиста вода. Миенето с вода да продължава до идването на лекар.



- При зареждане, акумулаторите отделят експлозивни газове, внимавайте да не се образуват искри или да се възпламенят. **НЕ ПУШЕТЕ.**

- Поставете акумулаторите, които се зареждат на проветриво място.



- Да се предпазват очите. Да се носят винаги предпазни очила, когато се работи с оловни акумулатори с киселина.



- Носете подходящо облекло. Не носете широки дрехи или бижута, които могат да се омотаят в движещи се части. По време на работа се препоръчва употребата на предпазно облекло, електрически изолирано, както и обувки, с покритие против подхлъзване. В случаи на дълга коса, косата да се прибира в шапка.



- Неопитните лица трябва да получат съответното обучение преди да използват апарата.

- Апаратът може да бъде използван от деца на възраст над 8 години и лица с намалени физически, сензорни или умствени способности, или без необходимите познания, стига да са под наблюдение или след като същите са получили инструкции, свързани с безопасната употреба на апарата и са разбрали опасностите, произтичащи от употребата.

- Децата не трябва да играят с апарата.

- Почистването и поддръжката, които трябва да се извършват от потребителя, не трябва да се извършват от деца без наблюдение.

- Зарядните устройства да се използват преди всичко в добре проветрени помещения: **ДА НЕ СЕ ОСТАВЯТ ДА РАБОТЯТ ДИРЕКТНО ПОД ДЪЖДА ИЛИ СНЕГА.**

- Извадете захранващия кабел от мрежата, преди да свържете или махнете кабелите за зареждане на акумулатора.

- Не свързвайте, нито махайте щипките от акумулатора при работещо зарядно устройство.

- Никога не използвайте зарядното устройство на акумулатора във вътрешността на автомобила или в багажника.

- При смяна на захранващия кабел, подменяйте го единствено с оригинален кабел.

- Ако захранващият кабел е повреден, то той трябва да бъде подменен от производителя или от негов сервис за техническо обслужване, или от лице с подобна квалификация, така че да се избегнат всякакви рискове.

- Не използвайте зарядното устройство, за зареждане на акумулатори, които не се зареждат.

- Проверете, дали захранващото напрежение, налично на работното място, отговаря на напрежението, посочено на табелата с технически данни върху зарядното устройство.

- За да не повредите електрониката на автомобилите, спазвайте стриктно предупрежденията, предоставени от производителите на автомобили или на акумулаторите, които използвате.

- Това зарядно устройство за акумулатори включва такива части като превключватели и релета, които могат да предизвикат появата на дъга или искри; затова, ако използвате зарядното устройство в гараж или друго подобно помещение, поставете го на подходящо за съхранението му, място.

- Операции, свързани с поправка или поддръжка във вътрешната част на зарядното устройство, трябва да бъдат извършвани само от квалифициран персонал.

- **ВНИМАНИЕ: ИЗВАЖДАЙТЕ ВИНАГИ ЗАХРАНВАЩИЯ КАБЕЛ ОТ МРЕЖАТА, ПРЕДИ ДА ИЗВЪРШИТЕ, КАКВАТО И ДА Е ОПЕРАЦИЯ ПО ПОДДРЪЖКАТА НА ЗАРЯДНОТО УСТРОЙСТВО, В ПРОТИВЕН СЛУЧАЙ СЪЩЕСТВУВА ОПАСНОСТ!**

- Зарядното устройство е защитено от директни контакти чрез заземяващ проводник, както е предписано за апарати от клас I. Проверете, дали контактът е снабден със защитно заземяване.

- В моделите, които липсват, свързани щепсел с подходящ капацитет, който не е по-малък от стойността на предпазителя, посочен на табелата с данни.



- Апаратура от клас A:

Това зарядно устройство удовлетворява изискванията на техническия стандарт за продукта при употреба в индустриална среда и за професионални цели. Не се гарантира електромагнитната съвместимост в жилищни сгради и в тези, които са свързани директно със захранваща мрежа с ниско напрежение, която захранва жилищните сгради.

2. ОБЩО ОПИСАНИЕ

Зарядно устройство, предназначено за зареждане на оловни акумулатори WET, EFB, GEL, AGM + (Ca) и литиеви акумулатори Li, използвани при превозни средства с двигател (бензин и дизел) и електрически превозни средства: автомобили, моторни превозни средства, мотоциклети, лодки и т.н.. Възможно е да се зареждат акумулатори от 12V, 24V; предвиден е също режим стартиране (само за превозни средства с бензинови или дизелови двигатели).

Акумулатори, които се зареждат в зависимост от наличното изходно напрежение: 12V / 6 клетки; 24V / 12 клетки.

3. ИНСТАЛИРАНЕ

ПОСТАВЯНЕ

- Разпокавайте зарядното устройство, извършете монтажа на отделните части, които се съдържат в опаковката.

- Моделите с количка трябва да се инсталират във вертикално положение.

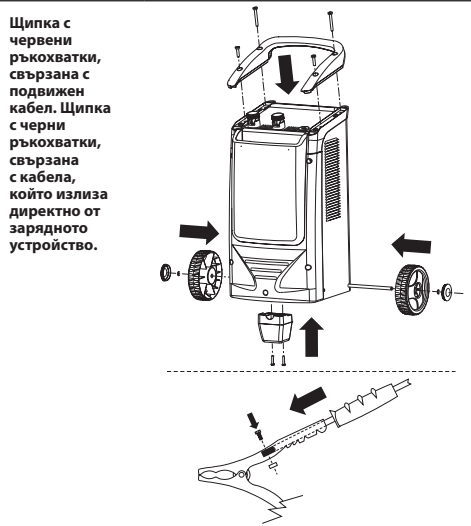

3.1 МЕСТОПОЛОЖЕНИЕ НА ЗАРЯДНОТО УСТРОЙСТВО

По време на функционирането, поставете зарядното устройство в стабилно положение като се уверите, че не е възпрепятствано преминаването на въздуха през специалните отвори като по този начин се гарантира достатъчна вентилация.

3.2 СВЪРЗАВАНЕ КЪМ ЕЛЕКТРИЧЕСКАТА МРЕЖА

- Зарядното устройство трябва да бъде свързано единствено със захранваща система с неутрален заземен проводник.

- Проверете, дали напрежението на електрическата мрежа съответства на напрежението за функциониране на зарядното устройство, посочено на табелата с данни.

- Захранващата линия трябва да е оборудвана със защитни системи като предпазители и автоматични прекъсвачи, достатъчни за да издържат при максимална консумация на апарата.
- Свързването към електрическата мрежа се осъществява със специалния захранващ кабел.
- Евентуални удължения на захранващия кабел трябва да са с подходящо сечение и все пак никога по-малко от това на захранващия кабел на апарата.
- Винаги е задължително апаратът да се заземи, като се използва проводника, който е жълто-зелен на цвят на захранващия кабел, отбелязан с етикет (↓), докато другите два проводника трябва да се свържат с фазата и нултралния проводник на разпределителната електрическа мрежа.

4. ФУНКЦИОНИРАНЕ ПРИ ЗАРЕЖДАНЕ

ЗАБЕЛЕЖКА: Преди да пристъпите към зареждане, проверете, дали капацитетът на акумулатора (Ah), който възнамерявате да зареждате не е по-малък от посочения на табелата с данни на зарядното устройство (Spin). Изпълнете инструкциите като следвате стриктно реда, посочен по-долу.

4.1 ПОДГОТОВКА НА АКУМУЛАТОРА

Ако акумулаторът за зареждане е от типа WET, процедирайте, както следва:

- Отстранете тапите на акумулатора (ако има такива), така че газовете, които се образуват по време на зареждане, да могат да излизат. Проверете, дали нивото на електролита покрива пластините на акумулатора, ако се окажат непокрити добавете дестилирана вода, докато се отоплят на 5-10 mm.



ВНИМАНИЕ! БЪДЕТЕ ИЗКЛЮЧИТЕЛНО ВНИМАТЕЛНИ ПО ВРЕМЕ НА ТАЗИ ОПЕРАЦИЯ, ТЪЙ КАТО ЕЛЕКТРОЛИТЪТ Е СИЛНО КОРОЗИВНА КИСЕЛИНА.

4.2 СВЪРЗВАНЕ НА ЗАРЯДНО УСТРОЙСТВО/АКУМУЛАТОР

- Проверете, дали захранващия кабел е свързан с контакта на мрежата.
 - За модели с повече от едно напрежение на зареждане, поставете девиаторния ключ или комутатора в съответствие с избраното напрежение на зареждане. При липса на девиаторен ключ или комутатор, свържете за целта кабела с червената щипка за зареждане (символ +) към специфичната клемма на зарядното устройство, в съответствие с избраното напрежение за зареждане.
 - Свържете щипката за зареждане с червен цвят към положителната клемма на акумулатора (символ +). Ако символите не се различават, напомняме, че положителната клемма, е тази, свързана за шасито на колата.
 - Свържете щипката за зареждане черен цвят към шасито на леката кола, далеч от акумулатора и тръбите за горивото.
- ЗАБЕЛЕЖКА:** ако акумулаторът не е инсталиран в леката кола, свържете директно с отрицателната клемма на акумулатора (символ -).

4.3 ЕДНОВРЕМЕННО ЗАРЕЖДАНЕ НА НЯКОЛКО АКУМУЛАТОРА

ВНИМАНИЕ: да не се зареждат едновременно акумулатори с различен капацитет, степен на изтощеност и от различен тип. Ако се налага да зареждате няколко акумулатора едновременно, може да се прибегне към "сериен" или "паралелно" свързване:

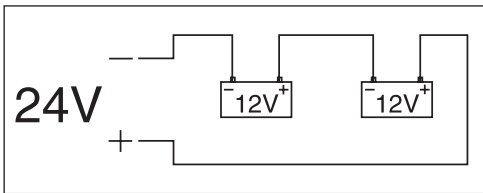

паралелно

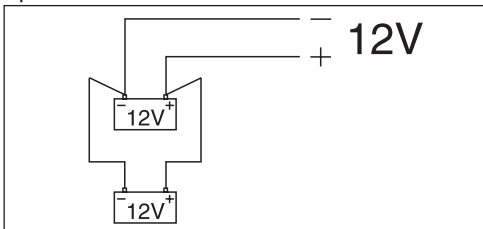

"Паралелното" свързване изисква акумулаторите да бъдат с едно и също номинално напрежение (Volt), съответстващо на изходното напрежение на зарядното устройство и сумата от Ah да се намира в гамата на зареждане на зарядното устройство.

"Сериеното" свързване изисква, акумулаторите да бъдат със същия капацитет (Ah) и сумата на номиналните напрежения да съответства на тази на изхода на зарядното устройство.

4.4 КРАЙ НА ЗАРЕЖДАНЕТО

- Прекъснете захранването на зарядното устройство като извадите щепсела на захранващия кабел от контакта на електрическата мрежа.
- Изключете щипките за зареждане черен цвят от шасито на автомобила или от отрицателната клемма на акумулатора (символ -).
- Изключете клещите за зареждане с червен цвят от положителната клемма на акумулатора (символ +).
- Поставете зарядното устройство на сухо място.
- Затворете клетките на акумулатора със специалните тапи (ако има такива).

5. ФУНКЦИОНИРАНЕ ПРИ СТАРТИРАНЕ

ВНИМАНИЕ: преди да пристъпите към тази дейност, спазвайте внимателно предупрежденията на производителите на автомобили!

- Уверете се, че захранващата линия е защитена с автоматични предпазители или прекъсвачи със стойност, съответстваща на посоченото в табелата със символ (—|—).
- За улесняване на стартирането, извършете предварително едно бързо зареждане от 10-15 минути, със зарядно устройство в положение за зареждане, а НЕ на стартиране.
- Ако автомобилът не се стартира, изчакайте няколко минути и повторете операцията по бързо зареждане. Не бъдете прекалено настоятелни, ако двигателят на автомобила не заработи: може сериозно да се повреди акумулаторът или даже електрическото оборудване на автомобила.

5.1 СВЪРЗВАНЕ НА ЗАРЯДНО УСТРОЙСТВО/АКУМУЛАТОР

- Уверете се преди да пристъпите към стартирането на автомобила, че стойността на номиналното напрежение на акумулатора съответства на зададената стойност на зарядното устройство.
- Уверете се, че акумулаторът е свързан към съответните клемми (+ и -), че свързванията към акумулатора са правилни и че акумулаторът е в добро състояние (не е сулфатизиран и не е повреден).
- Не извършвайте абсолютно никакво стартиране на автомобили с акумулатори, които са изключени от съответните клемми; наличието на акумулатора се определя от отстраняването на евентуални свръхнапрежения, поради ефекта на енергията, която може да се натрупа в кабелите за свързване по време на фазата на стартиране. **Неспазването на тези разпоредби може да повреди електрониката на автомобила.**

5.2 СТАРТИРАНЕ

- За избора на тази функция, виж илюстрация "СТАРТИРАНЕ".

5.3 КРАЙ НА СТАРТИРАНЕТО

- Извадете щепсела на захранващия кабел от контакта на захранващата мрежа.
- Отстранете щипката за зареждане с черен цвят от отрицателната клемма на акумулатора (символ -) и тази с червен цвят от положителната клемма на акумулатора (символ +).
- Поставете зарядното устройство на сухо място.

6. ЗАЩИТИ НА ЗАРЯДНОТО УСТРОЙСТВО

В зарядното устройство се включват защити автоматично в случай на:

- Свръхнагряване (прекомерно отдаване на ток към акумулатора).
- Късо съединение (клещи за зареждане, поставени в контакт помежду им).
- Обръщане на полярността на клемите на акумулатора.

При апаратите, които са оборудвани с предпазители, е задължително при подмяна, да се използва аналогични предпазители със същата стойност на номиналния ток.



ВНИМАНИЕ: Подмяната на предпазителя със стойности на тока, различни от посочените на табелата, може да причини щети на хора или предмети. Поради същата причина, абсолютно трябва да се избягва подмяната на предпазителя с медни мостове или друг материал. Операцията по подмяната на предпазителя трябва да се извършва винаги с ИЗКЛЮЧЕН захранващ кабел от мрежата. Бъдете внимателни при подмяната на лентовите предпазители, където ги има и затегнете здраво фиксиращите гайки.

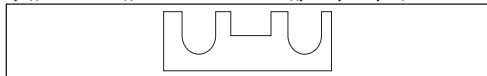

7. ПОЛЕЗНИ СЪВЕТИ

- Почистете положителната и отрицателната клемма от вероятни наслагвания от окисления, така че да осигурите добър контакт с щипките.
- Ако акумулаторът, върху който възнамерявате да използвате това зарядно устройство е постоянно включен към автомобила, направте справка с ръководството с инструкции и/или за поддръжка на автомобила в раздел "ЕЛЕКТРИЧЕСКА СИСТЕМА" или "ПОДДРЪЖКА".



UWAGA: PRZED UŻYCIEM PROSTOWNIKA DO ŁADOWANIA AKUMULATORÓW NALEŻY UWAŻNIE PRZECZYTAĆ INSTRUKCJĘ OBSŁUGI!

1. OGÓLNE BEZPIECZEŃSTWO PODCZAS UŻYTKOWANIA



- Unikaj kontaktu z kwasem zawartym w akumulatorze. W przypadku spryskania się kwasem lub też zetknięcia się z nim jakiegś części ciała należy natychmiast przemyć ją czystą wodą. Kontynuuj przemywanie aż do przyjazdu lekarza.



- Akumulatory podczas ładowania wydzielają gazy wybuchowe, należy unikać płomieni i isker. **NIE PALIĆ.**
 - Podczas ładowania ustawić akumulator w dobrze wietrzonym miejscu.



- Oslaniaj oczy. Podczas pracy z akumulatorami kwasowo-ołowiowymi zakładaj zawsze okulary ochronne.



- Ubierz się odpowiednio. Nie noś szerokiej odzieży lub biżuterii, które mogą zaplać się w ruchome części urządzenia. Podczas wykonywania operacji zaleca się stosowanie ochronnej odzieży izolowanej elektrycznie oraz obuwia przeciwpoślizgowego. Osoby noszące długie włosy muszą zakładać osłaniające nakrycie głowy.



- Przed użyciem urządzenia osoby niedoświadczone muszą zostać odpowiednio przeszkolone.
 - Urządzenie może być używane przez dzieci w wieku powyżej 8 lat oraz przez osoby o ograniczonych możliwościach fizycznych, czuciowych lub umysłowych nieposiadające doświadczenia lub wymaganej wiedzy, pod warunkiem, że będą z niego korzystały pod nadzorem lub po uzyskaniu wskazań dotyczących bezpiecznego użytkowania urządzenia i zrozumienia zagrożeń z nim związanych.
 - Nie pozwalaj dzieciom bawić się urządzeniem.
 - Czyszczenie i konserwacja, której wykonanie należy do obowiązków użytkownika nie może być wykonywane przez dzieci bez nadzoru.
 - Używać prostownika wyłącznie w dobrze wietrzonych pomieszczeniach: **NIE UŻYWAĆ NA ZEWNĄTRZ PODCZAS PADAJĄCEGO DESZCZU LUB SNIEGU.**
 - Przed podłączeniem lub odłączeniem przewodów podczas ładowania akumulatora należy odłączyć przewód zasilający.
 - Nie zakładać lub zdejmować klemy z akumulatora podczas funkcjonowania prostownika.
 - Surowo zabronione jest używanie prostownika wewnątrz pojazdu lub pod pokrywą komory silnika.
 - Uszkodzony przewód zasilania należy zastąpić wyłącznie przez oryginalny przewód.
 - Jeżeli przewód zasilania jest uszkodzony, musi zostać wymieniony przez producenta lub przez autoryzowany przez niego serwis techniczny lub w każdym razie przez osobę posiadającą podobne kwalifikacje, w sposób zapobiegający wszelkim zagrożeniom.
 - Nie używać prostownika do ładowania akumulatorów nie nadających się do ładowania.
 - Sprawdzić, czy napięcie zasilania będące do dyspozycji, odpowiada napięciu podanemu na tabliczce znamionowej prostownika.
 - Aby nie uszkodzić instalacji elektronicznej pojazdów należy ściśle przestrzegać zaleceń dostarczonych przez producentów tych pojazdów oraz zastosowanych w nich akumulatorów.
 - Prostownik składa się z wyłączników lub przełączników, które mogą powodować powstawanie łuków lub isker; dlatego też jeżeli używany jest w warsztacie samochodowym lub w innym podobnym otoczeniu, należy przechowywać w odpowiednim miejscu lub nie wyjmować opakowania.

- Wszelkiego rodzaju naprawy lub konserwacje prostownika powinny być przeprowadzane wyłącznie przez personel przeszkolony.
 - **UWAGA: PRZED WYKONANIEM JAKIEJKOLWIEK OPERACJI ZWYKLEJ KONSERWACJI PROSTOWNIKA NALEŻY ZAWSZE ODŁĄCZYĆ PRZEWÓD ZASILANIA, NIEBEZPIECZNE!**
 - Prostownik do ładowania akumulatorów zabezpieczony jest przed pośrednim kontaktem za pomocą przewodu uzimowego, zgodnie z zaleceniami przeznaczonymi dla urządzeń klasy I. Sprawdzić, czy gniazdo wtyczkowe wyposażone jest w styk ochronny.
 - W modelach, które nie są wyposażone, podłączyć wtyczki o odpowiedniej obciążalności prądowej, nie mniejszej od wartości bezpiecznika, wskazanej na tabliczce danych.



- Sprzęt klasy A:

Prostownik spełnia wymagania standardu technicznego w odniesieniu do produktu przeznaczonego do użytku wyłącznie w pomieszczeniach przemysłowych i w celach profesjonalnych. Nie jest gwarantowana zgodność z wymaganiami w zakresie pola elektromagnetycznego w budynkach domowych oraz w tych budynkach, które są podłączone bezpośrednio do sieci zasilania niskim napięciem budynków przeznaczonych do użytku domowego.

2. OGÓLNY OPIS

Prostownik zalecany do ładowania akumulatorów ołowiowych typu WET, EFB, GEL, AGM + (Ca) oraz baterii litowych Li stosowanych w pojazdach silnikowych (benzynowe i diesla) oraz w pojazdach elektrycznych: samochody osobowe, pojazdy silnikowe, motocykle, łódzie, itp. Umożliwia doładowywanie akumulatorów 12V, 24V; przewidziany jest również tryb automatycznego rozruchu (tylko dla pojazdów z silnikiem benzynowym i diesla). Akumulatory z możliwością doładowania w zależności od napięcia wyjściowego do dyspozycji: 12V / 6 ogniw; 24V / 12 ogniw.

3. INSTALOWANIE

PRZYGOTOWANIE

- Rozpakować prostownik i zamontować wszystkie odłączone części znajdujące się w opakowaniu.
 - Modele na podwoziu kołowym należy instalować w pozycji pionowej.

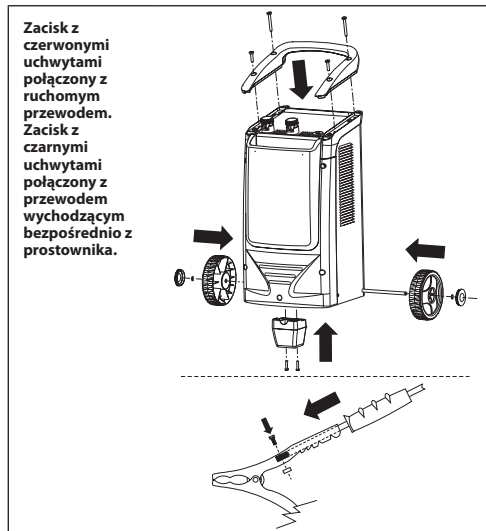

3.1 USYTUOWANIE PROSTOWNIKA

Podczas funkcjonowania należy umieścić prostownik na stabilnej powierzchni i sprawdzić czy występuje swobodny przepływ powietrza przez specjalne otwory, gwarantujący odpowiednią wentylację.

3.2 PODŁĄCZENIE DO SIECI ELEKTRYCZNEJ

- Prostownik należy podłączyć wyłącznie do sieci zasilania, w której znajduje się uziemiony przewód neutralny.
 - Sprawdzić czy napięcie sieci elektrycznej odpowiada wartości napięcia funkcjonowania prostownika, wskazanej na tabliczce danych.
 - Linia zasilania musi być wyposażona w systemy zabezpieczające, takie jak bezpieczniki lub wyłączniki automatyczne, dostosowane do maksymalnej

mocy pobieranej przez urządzenie.

- Podłączyć urządzenie do sieci wykorzystując odpowiedni przewód zasilający.
- Eventualne przedłużenia przewodu zasilającego powinny posiadać odpowiedni przekrój, nie mniejszy od przekroju przewodu, dostarczonego razem z urządzeniem.
- Należy zawsze podłączyć urządzenie do uziemienia, wykorzystując w tym celu przewód zasilający w kolorze żółto-zielonym, oznaczony etykietką (⏚), natomiast pozostałe dwa przewody należy podłączyć do fazy i przewodu neutralnego rozdzielczej sieci elektrycznej.

4. FUNKCJONOWANIE W TRYBIE ŁADOWANIA

Zauważ: Przed przystąpieniem do ładowania należy sprawdzić czy pojemność akumulatora (Ah), który zamierza się ładować nie jest mniejsza od pojemności podanej na tabliczce danych prostownika (Cmin). Postępować zgodnie z instrukcją, skrupulatnie przestrzegać wskazanej niżej kolejności.

4.1 PRZYGOTOWANIE AKUMULATORA

Jeżeli akumulator, który wymaga doładowania jest typu WET, należy postępować w następujący sposób:

- Zdjąć korki akumulatora, (jeśli występują), umożliwiając w ten sposób ulatnianie się gazów powstających podczas ładowania. Sprawdzić czy poziom elektrolitu zakrywa płytki akumulatora; jeżeli tak nie jest, należy dolać wody destylowanej, aż do ich zalania na 5 - 10 mm.

UWAGA! ZACHOWAĆ SZCZEGÓLNA OSTROŻNOŚĆ PODCZAS TEJ CZYNNOŚCI, PONIEWAŻ ELEKTROLIT JEST KWASEM WYSOCE KOROZYJNYM.



4.2 POŁĄCZENIE PROSTOWNIK/AKUMULATOR

- Sprawdzić czy wtyczka przewodu zasilającego jest odłączona od gniazda sieciowego.

- W przypadku modeli, w których występują różne napięcia ładowania należy ustawić wyłącznik lub przełącznik na wybraną wartość napięcia ładowania. Z braku wyłącznika lub przełącznika należy odpowiednio połączyć przewód z zaciskiem kleszczowym ładowania w kolorze czerwonym (symbol +) ze specyficznym zaciskiem prostownika, znajdującym się w pobliżu wybranego napięcia ładowania.
- Podłączyć zacisk kleszczowy przewodu ładującego koloru czerwonego do zacisku dodatkiego akumulatora (symbol +). Jeżeli symbole nie są dobrze widoczne przypomina się, że zacisk dodatni jest zaciskiem, który nie jest podłączony do podwozia pojazdu.
- Podłączyć zacisk kleszczowy przewodu ładującego koloru czarnego do podwozia pojazdu, w odpowiedniej odległości od akumulatora oraz od przewodu paliwa.

Uwaga: jeżeli akumulator nie został zamontowany w pojeździe, należy podłączyć się bezpośrednio do zacisku ujemnego akumulatora (symbol -).

4.3 JEDNOCZESNE ŁADOWANIE KILKU AKUMULATORÓW

UWAGA: Nie łączyć akumulatorów o różne pojemności, wyładowaniu i typologii. Jeśli należy łączyć kilka akumulatorów jednocześnie, można wykorzystać w tym celu połączenia „szeregowe” lub „równoległe”:

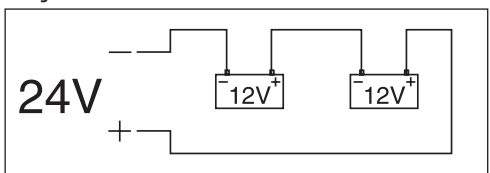

równoległe

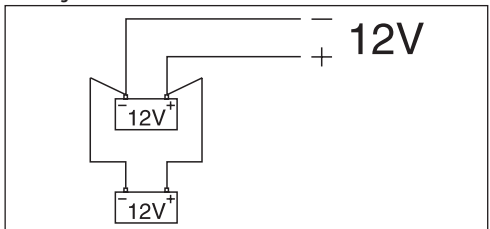

Połączenie „równoległe” wymaga tej samej wartości napięcia nominalnego akumulatorów (VoIt), która powinna odpowiadać wartości napięcia wyjściowego prostownika, natomiast suma amperogodzin (Ah) musi być zawarta w zakresie ładowania prostownika.

Połączenie „szeregowe” wymaga tej samej pojemności akumulatorowej (Ah) oraz sumy nominalnych napięć wszystkich akumulatorów, odpowiadającej napięciu wyjściowemu prostownika.

4.4 KONIEC ŁADOWANIA

- Odłączyć zasilanie od prostownika wyjmując wtyczkę przewodu zasilającego z gniazda sieci elektrycznej.
- Odłączyć kleszcze zaciskowe do ładowania koloru czarnego od podwozia pojazdu lub od zacisku ujemnego akumulatora (symbol -).
- Odłączyć kleszcze zaciskowe do ładowania koloru czerwonego od zacisku dodatkiego akumulatora (symbol +).
- Umieścić prostownik w suchym miejscu.
- Zamknąć ogniwa akumulatora zakładając specjalne korki, (jeżeli występują).

5. FUNKCJONOWANIE W TRYBIE ROZRUCHU

UWAGA: Podczas wykonywania tej czynności należy dokładnie przestrzegać zaleceń producentów pojazdów!

- Upewnić się, że linia zasilania została zabezpieczona za pomocą bezpieczników lub wyłączników automatycznych o odpowiedniej wartości, oznaczonej na tabliczce znamionowej symbolem (⏚-).
- Aby ułatwić rozruch, należy najpierw wykonać szybkie ładowanie 10-15 minutowe, przy użyciu prostownika ustawionego w pozycji ładowania i NIE rozruchowej.
- Jeśli pojazd nie zostanie uruchomiony, odczekać kilka minut i powtórzyć czynność szybkiego ładowania. Przerwać czynność, jeśli silnik pojazdu nie zostanie uruchomiony: istnieje możliwość poważnego uszkodzenia akumulatora, a nawet elektrycznego wyposażenia pojazdu.

5.1 POŁĄCZENIE PROSTOWNIK/AKUMULATOR

- Przed przystąpieniem do uruchomienia należy upewnić się czy wartość napięcia nominalnego akumulatora odpowiada wartości ustawionej w prostowniku.
- Upewnić się, że akumulator jest prawidłowo podłączony do odpowiednich zacisków (+ i -) oraz że podłączenia w kierunku akumulatora są prawidłowe i że akumulator jest w dobrym stanie (nie jest zasiarczony lub uszkodzony).
- Nie uruchamiać w żadnym wypadku pojazdów, których akumulatory zostały odłączone od odpowiednich zacisków; obecność akumulatora jest decydująca w celu wyeliminowania ewentualnych przepięć, które mogą powstawać podczas fazy uruchamiania, na skutek energii nagromadzonej w przewodach łączących. **Nieprzestrzeżenie tych zaleceń może powodować uszkodzenie instalacji elektronicznej pojazdu.**

5.2 URUCHAMIANIE

- Aby ustawić tę funkcję przejrzeć ilustrację „URUCHAMIANIE”.

5.3 KONIEC ROZRUCHU

- Wyjąć wtyczkę przewodu zasilającego z gniazda sieci zasilania.
- Odłączyć zacisk kleszczowy do ładowania koloru czarnego od zacisku ujemnego akumulatora (symbol -) oraz koloru czerwonego od zacisku dodatkiego akumulatora (symbol +).
- Umieścić prostownik w suchym miejscu.

6. ZABEZPIECZENIA PROSTOWNIKA

Prostownik zabezpiecza się samoczynnie w następujących przypadkach:

- Przeciążenie (nadmierne dostarczanie prądu do akumulatora).
- Zwarcie (kleszcze ładujące stykają się ze sobą).
- Odwrotna polaryzacja na zaciskach akumulatora.

W urządzeniach wyposażonych w bezpieczniki, w przypadku ich wymiany należy stosować podobne bezpieczniki, posiadające tę samą wartość prądu znamionowego.



UWAGA: Wymiana bezpiecznika o wartościach prądu odmiennych od wartości podanych na tabliczce może powodować wyrządzenie szkody na dla osób obsługujących urządzenie lub dla przedmiotów. Z tej samej przyczyny należy bezwzględnie unikać wymieniania bezpieczników na prostki miedziane lub mostki z innego materiału. Czynność wymiany bezpiecznika powinna być zawsze wykonywana po ODEŁĄCZENIU przewodu zasilającego od sieci. Zachować ostrożność podczas wymiany bezpiecznika płaskiego, gdzie występuje, mocno dokręć nakrętki mocujące.

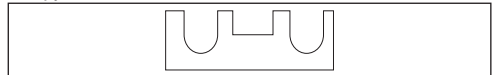

7. UŻYTECZNE WSKAZÓWKI

- Wyczyścić zacisk dodatni i ujemny z osadów tlenku, aby zapewnić w ten sposób dobry styk zacisków kleszczowych.
- Jeżeli akumulator, z którym zamierza się stosować ten prostownik jest na stałe zamontowany w pojeździe, należy przeczytać również instrukcję obsługi i/lub konserwacji pojazdu, pod hasłem "INSTALACJA ELEKTRYCZNA" lub "KONSERWACJA".

اليه بالنسبة للاجهزة من الفئة 1، تأكد من أن مأخذ الطاقة مزود اتصال بالخط الارضي للحماية.

- في النماذج الغير مزودة به، يتم التوصيل بقياس ذو حمل ملائم، لا يقل عن، قيمة الصمام المشار اليه على اللوحة الفنية.



انتبه: اقرأ بعناية دليل الإرشادات قبل إستخدام شاحن البطارية!



1. السلامة العامة للاستخدام



- تجنب ملامسة حمض البطارية، في حالة وجود بعض الرتوش من الحمض أو أية ملامسة لحمض البطارية، يتم شطف المنطقة المعنية على الفور بماء نظيف، استمر بالشطف حتى وصول الطبيب.



- تصدر البطاريات أثناء الشحن غازات متفجرة، فاحذر من التسبب في شرر وألسنة نيران. لا تدخن.
- ضع البطاريات أثناء الشحن في مكان جيد التهوية.



- يتم حماية العينين. دائماً يتم ارتداء نظارات واقية أثناء العمل بمخزونات الطاقة المحتوية على الرصاص الحمضي.



- يتم ارتداء ملابس مناسبة. لا يتم ارتداء ملابس فضفاضة أو مجوهرات قد تتعثر في أجزاء متحركة. خلال العمل ينصح باستخدام ملابس واقية ذات عزل كهربائي عازلة أو أحذية مضادة للانزلاق. في حالة الشعر الطويل يرجى ارتداء غطاء واقٍ للرأس.



- يجب تدريب الأشخاص الذين ليس لديهم خبرة بشكل ملائم على كيفية استخدام الجهاز.

- يمكن استخدام الجهاز من قبل أطفال أقل من عمر 8 سنوات وكذلك من قبل أشخاص من ذوي القدرات الجسمية والعقلية والحسية المنخفضة أو أولئك الغير متمتعين بالخبرات أو المعرفة الضرورية على أن يكونوا تحت الاشراف أو بعد أن يتلقوا إرشادات تتعلق بالاستخدام الآمن للجهاز واستيعاب الاخطار ذات الصلة.

- لا يجب أن يلعب الأطفال بالجهاز.

- لا يجب القيام بنظافة الجهاز وصيانته من قبل الأطفال دون الإشراف عليهم. استخدم شاحن البطارية فقط في الداخل وفي مكان جيد التهوية: لا تعرض شاحن البطارية للمطر أو الثلج.

- افصل الكابلات الكهربائي عن الكهرياء قبل توصيل أو فصل كابلات الشاحن من البطارية.

- لا تقم بتوصيل أو فصل الكماشات عن البطارية أثناء تشغيل شاحن البطارية. لا تستخدم على الإطلاق شاحن البطارية داخل السيارة أو غطاء محرك السيارة.

- استبدل الكابلات الكهربائي بكابل أصلي فقط. إذا تلف كابل التغذية بالطاقة فيجب استبداله من قبل الشركة المصنعة أو بواسطة خدمة الدعم الفني التابعة أو على أية حال من قبل أشخاص مؤهلين حتى يتم تحاشي جميع الأخطار.

- لا تستخدم شاحن البطارية لإعادة شحن بطاريات غير قابلة للشحن.

- تأكد أن الجهد الكهربائي المتاح متوافق مع الجهد المذكور على لوحة بيانات شاحن البطارية.

- حتى لا تلحق الأضرار بالكترونيات السيارة، اتبع بدقة تحذيرات الشركات المصنعة للسيارات أو البطاريات المستخدمة.

- يحتوي هذا الشاحن على أجزاء مثل مفاتيح تشغيل أو مرّ رحل كهربائي، والتي يُمكن أن تسبب حدوث شرارة أو قوس كهربائي؛ ولذلك عند استخدام شاحن البطارية في الجراج أو في مكان مماثل، ضعه في مكان مناسب للفرص.

- يجب أن تتم عمليات التصليح والصيانة داخل شاحن البطارية فقط من قبل أفراد ذوي خبرة.

- تبيبه: افصل دائماً الكابلات الكهربائي عن الكهرياء قبل إجراء أي صيانة بسيطة في شاحن البطارية، فهذا خطراً!

- مصون من الاتصالات الغير مباشرة بواسطة موصل بالخط الارضي كما هو مشار

أجهزة من النوع A:

يفي شاحن البطاريات هذا بمتطلبات معيار المنتج الفني لاستخدامه في الأغراض الصناعية والمهنية، ليس مضموناً الامتثال مع التوافق الكهرومغناطيسي في المباني السكنية وفي تلك التي ترتبط مباشرة بشبكة الجهد المنخفض التي تمد بالطاقة مباتي للاستخدام المنزلي.

2. وصف عام

شاحن بطاريات مشار اليه لشحن بطاريات تعمل برصاص AGM و GEL و EFB و WET و (Ca) و بطاريات الليثيوم المستخدمة على مركبات ذات محركات تعمل بـ (البززين والوسولان) ومركبات كهربائية: سيارات، دراجات نارية، دراجات بخارية، مركاب، ألخ. يمكن إعادة شحن بطاريات بقدرة 12 فولت و 24 فولت؛ هناك أيضاً طريقة بدء التشغيل (فقط بالنسبة للمركبات التي تعمل بمحركات بزين وسولار).

مخزونات طاقة قابلة للشحن وفقاً لوظيفة الجهد الصادر المتاحة: 12 فولت / 6 خلية؛ 24 فولت / 12 خلية.

3. التركيب

الاعداد

- يجب إعادة الاغلاق عن شاحن البطاريات والقيام بتركيب الاجزاء المنفصلة عنه والحماية في التغليف.
- يتم تركيب النماذج المزودة بعجلات في وضع رأسي.

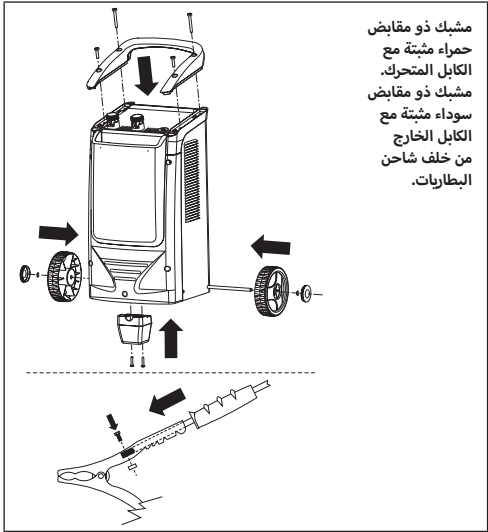

مشبك ذو مقابض
حزمة مشببة مع
الكابل المتحرك.
مشبك ذو مقابض
سوداء مشببة مع
الكابل الخارج
من خلف شاحن
البطاريات.

1.3. وضعية شاحن البطاريات

خلال عمل الجهاز، يتم وضع شاحن البطارية في وضعية مستقرة مع التأكد من عدم إندساد نمر الهواء من خلال الفتحات الخاصة بذلك مع ضمان التهوية الكافية.

2.3. التوصيل بالشبكة الكهربائيّة

- يجب توصيل شاحن البطارية حصرياً بنظام تغذية الطاقة ذو موصل محايد متصل بالأرض.

- تأكد من أن جهد شبكة الكهرياء يعادل جهد تشغيل شاحن البطاريات الوارد على لوحة البيانات.

- يجب أن يكون خط التغذية بالطاقة مزود بأنظمة وقائية والتي من بينها الصمامات أو مفاتيح التبادل التلقائية التي تكون كافية لتحمل أقصى حد من استهلاك الجهاز للطاقة.

- يجب أن يتم التوصيل بشبكة الكهرياء بواسطة الكابلات المخصص لذلك.

- يجب أن تكون أسلاك الاطالة المحتملة لكابل التغذية بالطاقة ذات فئة ملائمة وألا تقل أبداً عن تلك الخاصة بكابل التغذية بالطاقة للجهاز.

- من اللازمي دائماً توصيل الجهاز بالخط الارضي باستخدام الموصل ذو اللون الاصفر-

الاحضر لكابل التغذية والطاقة والمميز بالبطاقة (⚡) في حين أن الموصلان الاخراين يتم توصيلهما بالمرحلة والمحادي لشبكة توزيع الكهرباء.

4. التشغيل أثناء الشحن

لاحظ جيداً: قبل مباشرة الشحن تحقق من أن قدرة البطارية (Ah) التي يتوى شحنها لا تقل عن تلك القدرة المشار إليها على لوحة شاحن البطارية (C min). قرر بتنفيذ التعليمات مع الالتزام التام بالترتيب الوارد أسفله.

1.4 إعداد البطارية

إذا كانت البطارية المراد شحنها من نوع WET يتم المباشرة كما يلي:
- قرر بإزالة أغطية البطارية (إن وجدت) حتى تخرج الغازات الناتجة خلال الشحن.
- تحقق من أن مستوى الالكتروليت يغطى شرائح البطارية؛ إذا كانت الشرائح مكمشوفة، إذأ أضف الماء المقطر حتى تغطيتها بحوالي 10-5 م.



إنتبه! يجب الحذر التام خلال القيام بهذه العملية لأن الاكثوليت عبارة عن حمض يسبب التآكل بدرجة عالية للغاية.

2.4 توصيل شاحن البطارية/البطارية

- تأكد من أن كابل التغذية يكون مفصلاً عن فيشة التوصيل بالشبكة.
- بالنسبة للموديلات ذات جهود الشحن المتعددة ضع مغير التيار أو المبادل الكهربائي بشكل متوافق مع جهد الشحن المختار مسبقاً في غياب مغير التيار أو المبادل الكهربائي، قرر بتوصيل الكابل بشكل مناسب مع كمامة الشحن الحمراء (+) على الكتلة الطرفية الخاصة بشاحن البطاريات وفقاً لجهد الشحن المختار مسبقاً.
- قرر بتوصيل مشبك الشحن ذو اللون الاحمر مع المشبك الموجب للبطارية (رمز +). إذا لم تتمكن من التمييز بين الرموز تذكر أن المشبك الموجب هو ذلك الغير متصل بهيكل السيارة.
- قرر بتوصيل مشبك الشحن ذو اللون الاسود بهيكل السيارة بعيداً عن البطارية وبعيداً عن موصل الوقود.
- ملاحظة: إذا لم تكن البطارية غير مثبتة بالسيارة قرر بتوصيلها مباشرة مع المشبك السالب للبطارية (الرمز-).

3.4 الشحن المتزامن لأكثر من بطارية

إنتبه: لا تقم بشحن بطاريات ذات قدرات، أو فارغة من الشحن أو تنتمي لفئات مختلفة فيما بينها. مع وجوب شحن أكثر من بطارية في نفس الوقت يمكن اجراء توصيلات "فتوتية" أو "متوازنة":

فتوتية

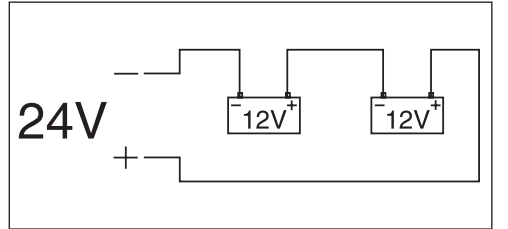

متوازنة

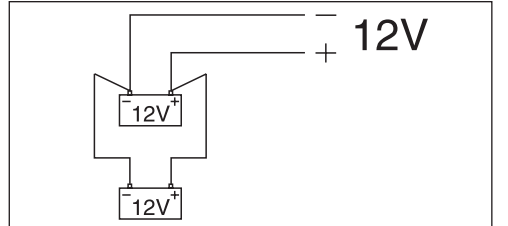

إن التوصيل بطريقة "التوازي" يتطلب أن تحمل البطاريات نفس الجهد الاسمي (الفولت) الذي يعادل ذلك الخارج من شاحن البطاريات وأن إجمالي قدرة البطاريات أي الامبير في الساعة Ah مشتمل في مجموعة شحن شاحن البطاريات.
التوصيل بالطريقة "الفتوتية" يتطلب أن تتمتع البطاريات بنفس القدرة (Ah) وأن مجموع الجهود الاسمية لجميع البطاريات يعادل ذلك الخارج من شاحن البطاريات.

4.4 نهاية الشحن

- قرر بفصل الطاقة عن شاحن البطارية بنزع كابل التغذية بالطاقة من مأخذ الطاقة.
- قرر بفصل مشبك الشحن ذو اللون الاسود عن هيكل السيارة أو من المشبك السالب للبطارية (رمز -).
- قرر بفصل مشبك الشحن ذو اللون الاحمر من المشبك الموجب للبطارية (رمز +).
- ضع شاحن البطارية في مكان جاف.
- قرر بفلق خلايا البطارية مجدداً بواسطة الاغطية الخاصة بذلك (إن وجدت).

5. التشغيل بمرحلة البدء

إنتبه: قبل المباشرة يجب القراءة بعناية للتعليمات الخاصة بصانع المركبة!
- يجب التأكد من حماية خط التغذية بالطاقة من خلال صمامات ومفاتيح قطع دائرة التغذية بالطاقة أوتوماتيكياً وفقاً للقيم المعادلة الموضحة على لوحة البيانات المصيرة بالرمز (⚡).
- لتسهيل بدء التشغيل يتم القيام أولاً بشحن سريع من 10 إلى 15 دقيقة مع شاحن البطارية على وضعية الشحن وليس على وضعية بدء التشغيل.
- إذا لم يتم بدء المركبة بالعمل، إنتظر بضع دقائق ثم كرر اجراء الشحن السريع للبطارية. لا تصر أكثر إذا لم يعمل محرك المركبة؛ يمكن أن يتسبب ذلك في إتلاف البطارية أو الاجهزة الكهربائيّة للمركبة.

1.5 توصيل شاحن البطارية/البطارية

- تحقق قبل مباشرة بدء تشغيل المركبة من أن قيمة الجهد الاسمي للبطارية يعادل القيمة التي تم إعدادها في شاحن البطارية.
- تأكد من أن البطارية موصلة بشكل جيد مع المشابك (+ و -) وأن التوصيلات تجاه البطارية صحيحة وأن البطارية بحالة جيدة (غير مفسفرة وغير تالفة).
- لا تقم بأي شكل من الاشكال ببدء تشغيل المركبة عندما تكون البطارية منفصلة عن المشابك ذات الصلة؛ حيث أن وجود البطارية هام بالنسبة لإلغاء احتمالية وجود أحمال زائدة قد تولد من تراكم الطاقة في كابلات التوصيلات خلال مرحلة بدء التشغيل. إن عدم الاخذ في الاعتبار لهذه الاحكام قد يضر بالاجهزة الالكترونية للمركبة.

2.5 بدء التشغيل

- لاختيار هذه الوظيفة أنظر الإرشادات المصورة "بدء التشغيل".

3.5 نهاية بدء التشغيل

- ازرع قابس كابل التغذية بالطاقة من مأخذ الطاقة.
- قرر بفصل كمامة الشحن ذات اللون الاسود عن المشبك السالب للبطارية (الرمز -) وتلك ذات اللون الاحمر عن المشبك الموجب للبطارية (الرمز +).
- ضع شاحن البطارية في مكان جاف.

6. وضعيات شاحن البطاريات

يتمتع شاحن البطاريات بحماية ذاتية في الحالات التالية:
- الحمل الزائد (الاصدار الزائد للتيار تجاه البطارية).
- قصر الدائرة الكهربائيّة (تلامس مشبك الشحن مع بعضهما).
- تبديل الاقطاب على مشابك البطارية.
في الاجهزة المزودة بصمام فإنه من الحتمي في حالة الاستبدال استخدام قطع غيار مماثلة لها نفس قيمة التيار الاسمي.



إنتبه: قد يتسبب استبدال الصمام بقيم تيار مختلفة عن تلك المشار إليها على اللوحة في حدوث أضرار لاشخاص أو أشياء. لنفس السبب تجنب مطلقاً استبدال الصمام بواسطة وصلات من النحاس أو خامات أخرى. إن عملية استبدال الصمام يتم تنفيذها عندما يكون كابل التغذية بالطاقة معزول عن الشبكة. يجب الحذر عند القيام باستبدال الصمام على شكل شريط، إن وجد، مع إحكام صواميل الثبيت جيداً.



7. نصائح مفيدة

- قرر بتنظيف القطبين السالب والموجب من قشور الاكسدة المحتملة بطريقة تسمح بالتوصيل الجيد للمشابك.
- إذا كانت البطارية التي يراد شحنها بشاحن البطارية مثبتة بشكل دائر بالمركبة يجب الرجوع أيضاً إلى الإرشادات و/أو دليل صيانة المركبة والواردة في بند "النظام الكهربائي" أو "الصيانة".

LCD DISPLAY (pag. 2)

1. Set battery voltage.
2. Main Display: voltage-current measured in the battery, selected Ah, voltage value selected for the Supply / Equalization programs, messages for the operator, alarm code.
3. Polarity reverse alarm, short circuit, worn or faulty battery.
4. Set current and voltage.
"AL1 - AL9" Alarm code.
5. Battery charge level.
6. PULSE-TRONIC Charge current choice: AUTO, BOOST, Customized (Ah setting).
7. Low temperature operation.
9. EQUALIZATION Mode.
10. DESULFATION Mode.
11. Battery type choice:
WET: lead batteries, liquid electrolyte.
GEL: lead batteries, sealed, solid electrolyte.
AGM: lead batteries, sealed, electrolyte on absorbent material.
+ (CA): lead-calcium batteries.
12. SUPPLY Mode.
14. PULSE-TRONIC charging steps.
15. START mode.
16. Automatic charge Mode.
17. PulseTronic Charge.
18. Charging circuit operation Test (alternator).
19. Battery starting capacity Test - CCA.
20. Battery charge status Test .
21. VOLT - Setting button:
- 12/24V battery voltage.
- voltage/Ah adjustment.
22. FUNCTION - Setting button:
- PULSE-TRONIC CHARGE (AUTO, AUTO ^{*}, WET, EFB, GEL, AGM +, Li).
- TEST (battery status, vehicle's alternator, battery starting capacity).
- Advanced Programs (DESULFATION, EQUALIZATION, SUPPLY).
- voltage/Ah adjustment.
23. MODE - Setting button:
- Output current (AUTO, BOOST, customized).
- START Mode.

FUNCTIONS

- A. PULSE-TRONIC CHARGE
- B. TEST
- CHARGE STATUS TEST
- BATTERY START CAPABILITY (CCA)
- ALTERNATOR TEST
- C. BATTERY MAINTENANCE
- DESULFATION
- EQUALIZATION
- D. POWER SUPPLY
- SUPPLY
- E. START

INFO ALARM

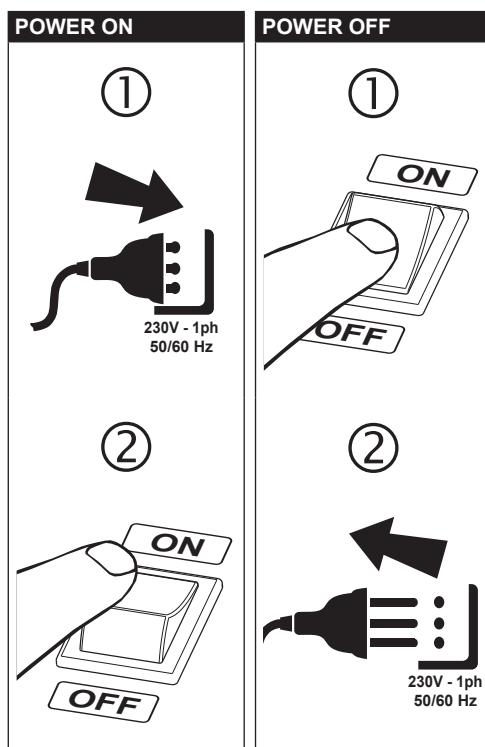

A CHARGE/MAINTENANCE

PULSE-TRONIC TECHNOLOGY

Pulse^{TRONIC}



1 PULSE-TRONIC SELECTION

FUNCTION



DISPLAY

Pulse^{TRONIC}

2 BATTERY TYPE SELECTION

FUNCTION



DISPLAY

AUTO

AUTO ❄️

WET EFB GEL AGM + Li

▲



AUTOMATIC

AUTOMATIC WINTER T<0°C

MANUAL

3 CURRENT SELECTION

MODE



DISPLAY

AUTO

AUTO BOOST

Ah (●)



AUTOMATIC

QUICK CHARGE

MANUAL

3A (●) Ah SETTING - EXAMPLE

MODE

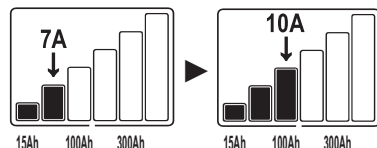

DISPLAY

85 Ah

VOLT



80Ah
75Ah
70Ah

FUNCTION



100Ah
95Ah
90Ah

4 VOLTAGE SELECTION

VOLT



DISPLAY

12v 24v

▲



Info Alarm

5 CLAMP CONNECTION

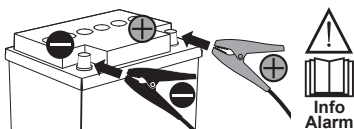

START AFTER 5"

6 PULSE-TRONIC GRAPHIC

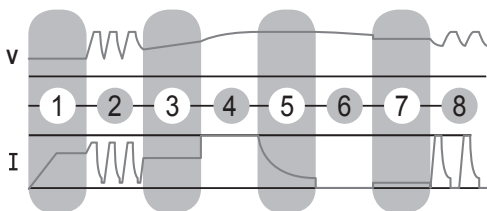

- 1 Battery test
- 2 Recovery of sulphated/very low batteries
- 3 Integrity control
- 4 Charge up to 80%
- 5 Charge up to 100%
- 6 Charge maintenance monitor
- 7 Charge maintenance
- 8 Pulse charge recovery

7 END OF CHARGE - EXAMPLE

12v

OK

1 2 3 4 5 6 7 8

Pulse^{TRONIC}

GEL

AUTO

B TEST

CHARGE STATUS



1 TEST SELECTION

FUNCTION



DISPLAY
TEST



2 BATTERY TYPE SELECTION

FUNCTION



DISPLAY
WET EFB GEL AGM + Li



3 CLAMP CONNECTION

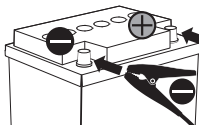

4 VOLTAGE SELECTION

VOLT



DISPLAY

12v 24v



5 END OF TEST - EXAMPLE



DISPLAY LEGENDA



to be charged



to be charged



full

B TEST

BATTERY START CAPABILITY



1 TEST SELECTION

FUNCTION



DISPLAY
TEST



2 CLAMP CONNECTION

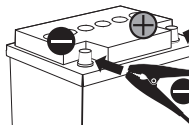

3 VOLTAGE SELECTION

VOLT



DISPLAY

12v 24v



DISPLAY

Go

4 VEHICLE'S STARTING



5 END OF TEST - EXAMPLE



DISPLAY LEGENDA

OK

working

SUF

sufficient

bad

insufficient

B TEST

ALTERNATOR



1 TEST SELECTION

FUNCTION



DISPLAY



2 CLAMP CONNECTION

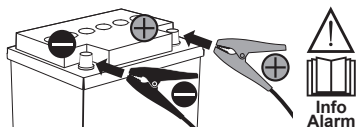

3 VOLTAGE SELECTION

VOLT



DISPLAY

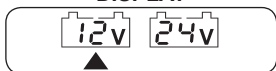

DISPLAY



4 VEHICLE'S STARTING



5 END OF TEST - EXAMPLE



DISPLAY LEGENDA

OK working	SUF sufficient	bAd insufficient
----------------------	--------------------------	----------------------------

C MAINTENANCE

DESULFATION

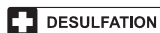

1 ADVANCED MENU SELECTION

FUNCTION



MENU

ADVANCED
PROGRAMS

2 FUNCTION SELECTION

FUNCTION



DISPLAY

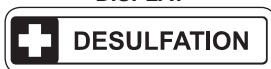

3 VOLTAGE SELECTION

VOLT



DISPLAY

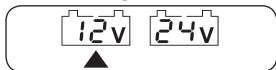

4 CLAMP CONNECTION

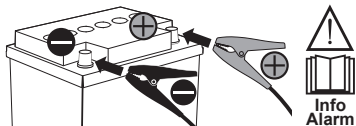

START AFTER 5"

5 END OF PROCESS - EXAMPLE

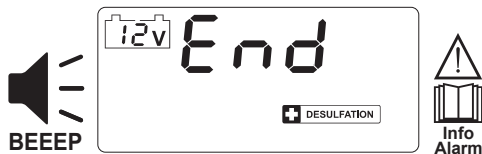

6 EXIT - ADVANCED MENU

FUNCTION



C MAINTENANCE

EQUALIZATION



1 ADVANCED MENU SELECTION

FUNCTION

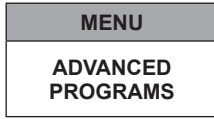

2 FUNCTION SELECTION

FUNCTION



3 VOLTAGE SELECTION

VOLT

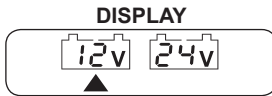

3A VOLTAGE ADJUSTMENT - EXAMPLE



CHECK BATTERY TYPE (WET, EFB, GEL, AGM +, Li) AND MAX. ALLOWED VOLTAGE.

VOLT



FUNCTION



3"

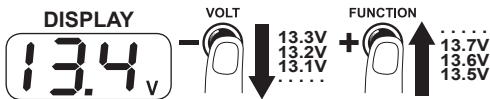

4 CLAMP CONNECTION

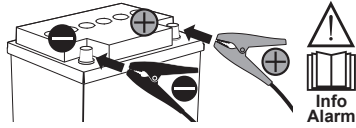

START AFTER 5"

5 END OF PROCESS - EXAMPLE

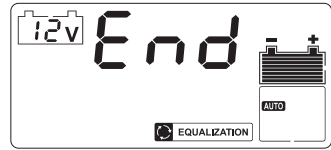

6 EXIT - ADVANCED MENU

FUNCTION



KEYBOARD LOCK/UNLOCK

LOCK
VOLT



MODE



3"

DISPLAY



UNLOCK
VOLT



MODE



3"

DISPLAY



D POWER SUPPLY

SUPPLY

SUPPLY

BATTERY CHANGE

1 ADVANCED MENU SELECTION

FUNCTION

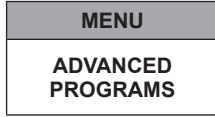

2 FUNCTION SELECTION

FUNCTION



DISPLAY



VOLTAGE BETWEEN CLAMPS (MAX 27V).

3 VOLTAGE SELECTION

VOLT



DISPLAY

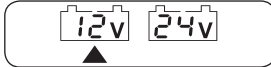

3A VOLTAGE CUSTOMIZATION - EXAMPLE



CHECK MAX. VOLTAGE ALLOWED IN THE VEHICLE MANUFACTURER'S INSTRUCTIONS.

VOLT



FUNCTION



DISPLAY



VOLT



13.3V
13.2V
13.1V
.....

FUNCTION



13.7V
13.6V
13.5V

3B CURRENT ADJUSTMENT - EXAMPLE

MODE

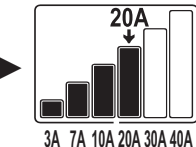
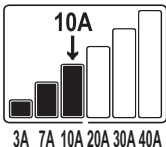

4 DISPLAY - EXAMPLE



5 CLAMPS CONNECTION TO VEHICLE'S BATTERY CABLES

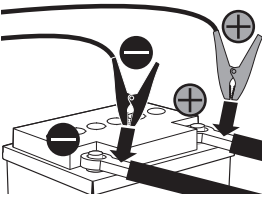

6 SUPPLIED VEHICLE



BATTERY REMOVAL



BATTERY CHANGE

7 EXIT - ADVANCED MENU

FUNCTION



KEYBOARD LOCK / UNLOCK

LOCK

VOLT



MODE



DISPLAY



UNLOCK

VOLT



MODE



DISPLAY

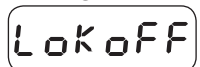

E START

START

12V

1 FUNCTION SELECTION

MODE



DISPLAY

START

2 VOLTAGE SELECTION

VOLT



DISPLAY

12V 24V



Info Alarm

3 CLAMPS CONNECTION TO BATTERY

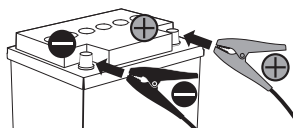

Info Alarm

DISPLAY

Go

4 VEHICLE'S STARTING



5 TIMER 30" FOR FOLLOWING START

DISPLAY

30
29
28

6 FUNCTION EXIT

MODE



INFO ALARM



Info Alarm

AL 1

SHORT CIRCUIT

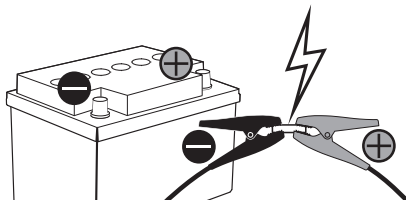

POLARITY REVERSAL

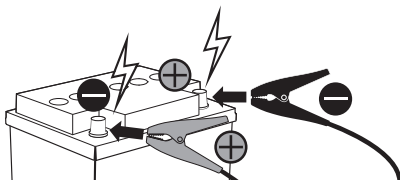

AL 2

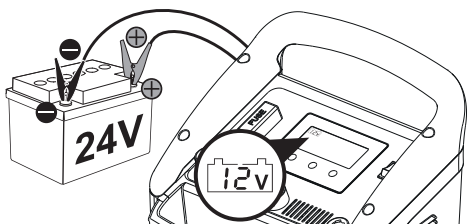

AL 4

AL 5

AL 6

AL 7

AL 8

Pulse Tronic



AL 9

SHORT CIRCUIT

EQUALIZATION

DIAGNOSTIC

SUPPLY

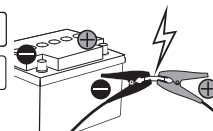

INDICATORS
OVERHEATING
Automatic reset

000



THERMAL
ALARM

0C



DISPLAY LCD (pag. 2)

1. Tensione della batteria impostata.
2. Display principale: tensione-corrente misurata di batteria, Ah di selezione, valore di tensione selezionato per i programmi di Supply / Equalization, messaggi di interfaccia verso operatore, codici di allarme.
3. Allarme per inversione polarità, corto circuito, batteria usurata o guasta.
4. Corrente e tensione impostata.
5. Codici di allarme "AL1 - AL9".
6. Livello di carica della batteria.
7. Scelta corrente di carica PULSE-TRONIC: AUTO, BOOST, Personalizzata (impostazione Ah).
8. Funzionamento a basse temperature.
9. Modalità EQUALIZATION.
10. Modalità DESULFATION.
11. Scelta tipologia batteria:
 - WET: batterie al piombo, elettrolita liquido.
 - GEL: batterie al piombo, sigillate, elettrolita solido.
 - AGM: batterie al piombo, sigillate, elettrolita su materiale assorbente.
 - + (CA): batterie al piombo calcio.
12. Modalità SUPPLY.
14. Fasi carica PULSE-TRONIC.
15. Modalità START.
16. Modalità di carica automatica.
17. Carica in PulseTronic.
18. Test funzionamento circuito di ricarica (alternatore).
19. Test capacità avviamento batteria - CCA.
20. Test stato di carica batteria.
21. VOLT - Pulsante impostazione:
 - tensione di batteria 12/24V.
 - regolazione voltaggio/Ah.
22. FUNCTION - Pulsante impostazione:
 - CARICA PULSE-TRONIC (AUTO, AUTO ✱, WET, EFB, GEL, AGM +, Li).
 - TEST (stato batteria, alternatore veicolo, capacità avviamento batteria).
 - Programmi Avanzati (DESULFATION, EQUALIZATION, SUPPLY).
 - regolazione voltaggio/Ah.
23. MODE - Pulsante impostazione:
 - corrente di uscita (AUTO, BOOST, personalizzata).
 - Modalità START.

FUNZIONI

- A. CARICA PULSE-TRONIC
- B. TEST
 - TEST STATO DI CARICA
 - TEST CAPACITÀ AVVIAMENTO BATTERIA (CCA)
 - TEST ALTERNATORE
- C. MANUTENZIONE BATTERIE
 - DESOLFATAZIONE
 - EQUALIZZAZIONE
- D. ALIMENTAZIONE
 - SUPPLY
- E. AVVIAMENTO - START

INFO ALLARMI

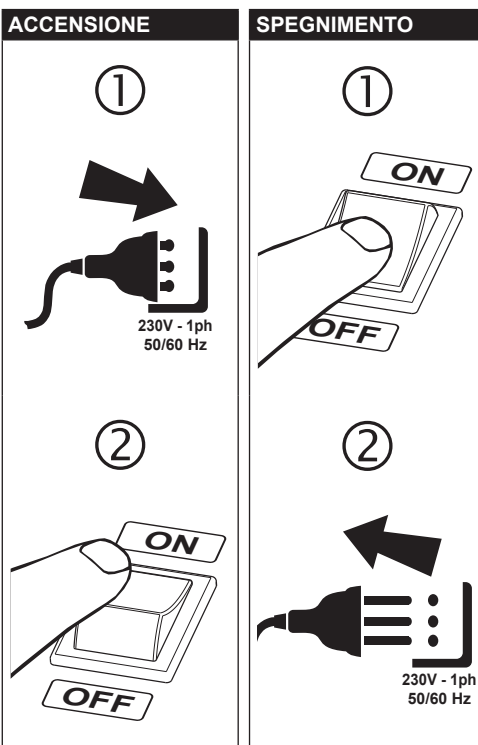

A CARICA/MANTENIMENTO

PULSE-TRONIC TECHNOLOGY

Pulse^{TRONIC}



1 SELEZIONE PULSE-TRONIC

FUNCTION



DISPLAY

Pulse^{TRONIC}

2 SELEZIONE TIPOLOGIA BATTERIA

FUNCTION



DISPLAY

AUTO

AUTO

WET EFB GEL AGM + Li



AUTOMATICA

AUTOMATICA
INVERNO T<0°C

MANUALE

3 SELEZIONE CORRENTE

MODE



DISPLAY

AUTO

AUTO BOOST

Ah (●)



AUTOMATICA

CARICA RAPIDA

MANUALE

3A (●) IMPOSTAZIONE Ah - ESEMPIO

MODE

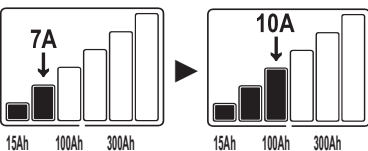

DISPLAY

85 Ah

VOLT

-



80Ah
75Ah
70Ah

FUNCTION

+



100Ah
95Ah
90Ah

4 SELEZIONE TENSIONE

VOLT



DISPLAY

12v 24v



5 COLLEGAMENTO PINZE

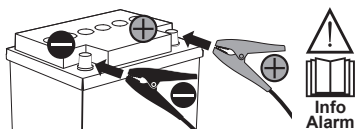

Info Alarm

AVVIO DOPO 5"

6 GRAFICO PULSE-TRONIC

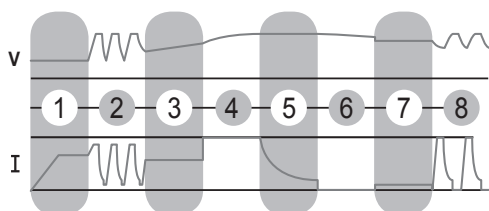

- 1 Test di batteria
- 2 Recupero batterie solfatate/molto scariche
- 3 Controllo integrità
- 4 Carica fino all'80%
- 5 Carica fino al 100%
- 6 Monitor tenuta carica
- 7 Mantenimento carica
- 8 Ripristino carica a impulsi

7 FINE CARICA - ESEMPIO



B TEST

STATO DI CARICA



1 SELEZIONE TEST

FUNCTION



DISPLAY
TEST



2 SELEZIONE TIPOLOGIA BATTERIA

FUNCTION



DISPLAY
WET EFB GEL AGM + Li



3 COLLEGAMENTO PINZE

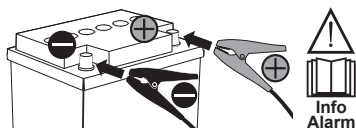

4 SELEZIONE TENSIONE

VOLT



DISPLAY

12V 24V



5 FINE TEST - ESEMPIO



LEGENDA DISPLAY



B TEST

CAPACITÀ AVVIAMENTO BATTERIA



1 SELEZIONE TEST

FUNCTION



DISPLAY
TEST



2 COLLEGAMENTO PINZE

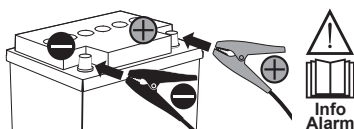

3 SELEZIONE TENSIONE

VOLT



DISPLAY

12V 24V



DISPLAY

Go

4 AVVIAMENTO VEICOLO



5 FINE TEST - ESEMPIO



LEGENDA DISPLAY



B TEST

ALTERNATORE



1 SELEZIONE TEST

FUNCTION



DISPLAY



2 COLLEGAMENTO PINZE

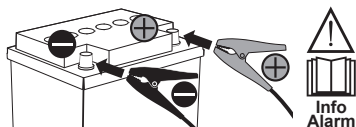

3 SELEZIONE TENSIONE

VOLT



DISPLAY

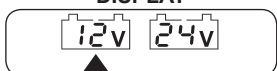

DISPLAY



4 AVVIAMENTO VEICOLO



5 FINE TEST - ESEMPIO



LEGENDA DISPLAY

OK	SUF	bAd
funzionante	sufficiente	insufficiente

C MANUTENZIONE

DESOLFATAZIONE

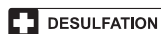

1 SELEZIONE MENU AVANZATO

FUNCTION



MENU

ADVANCED PROGRAMS

2 SELEZIONE FUNZIONE

FUNCTION



DISPLAY

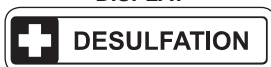

3 SELEZIONE TENSIONE

VOLT



DISPLAY



4 COLLEGAMENTO PINZE

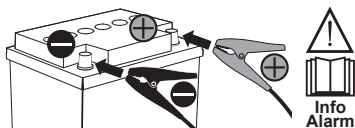

AVVIO DOPO 5"

5 FINE PROCESSO - ESEMPIO

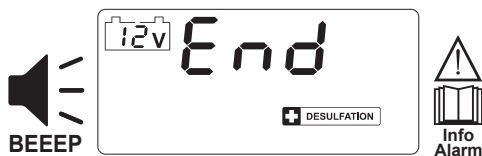

6 USCITA MENU AVANZATO

FUNCTION



C MANUTENZIONE

EQUALIZZAZIONE

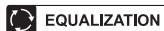

1 SELEZIONE MENU AVANZATO

FUNCTION



4 COLLEGAMENTO PINZE

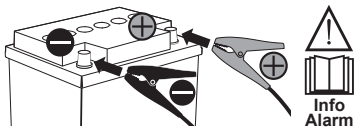

AVVIO DOPO 5"

2 SELEZIONE FUNZIONE

FUNCTION



5 FINE PROCESSO - ESEMPIO

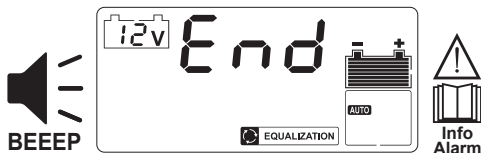

3 SELEZIONE TENSIONE

VOLT

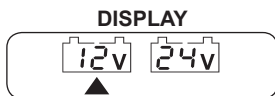

6 USCITA MENU AVANZATO

FUNCTION



BLOCCO / SBLOCCO TASTIERA

BLOCCO

VOLT



MODE



DISPLAY



SBLOCCO

VOLT



MODE



DISPLAY



3A PERSONALIZZAZIONE TENSIONE - ESEMPIO



VERIFICARE IL TIPO DI BATTERIA (WET, EFB, GEL, AGM +, Li) E LA MAX. TENSIONE AMMESSA.

VOLT



FUNCTION



DISPLAY



VOLT



13.3V
13.2V
13.1V
.....

FUNCTION



13.7V
13.6V
13.5V

D ALIMENTAZIONE

SUPPLY

SUPPLY

CAMBIO BATTERIA

1 SELEZIONE MENU AVANZATO

FUNCTION

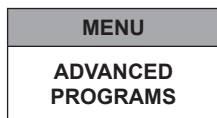

2 SELEZIONE FUNZIONE

FUNCTION



DISPLAY



PRESENZA TENSIONE TRA LE PINZE (MAX 27V).

3 SELEZIONE TENSIONE

VOLT



DISPLAY

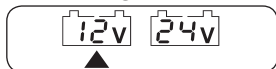

3A PERSONALIZZAZIONE TENSIONE - ESEMPIO



VERIFICARE DALLE SPECIFICHE DEL COSTRUTTORE DEL VEICOLO LA MAX. TENSIONE AMMESSA.

VOLT



FUNCTION



DISPLAY



VOLT



13.3V
13.2V
13.1V

FUNCTION



13.7V
13.6V
13.5V

3B PERSONALIZZAZIONE CORRENTE - ESEMPIO

MODE

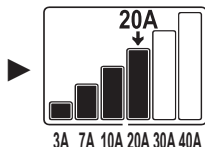
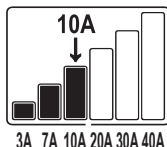

4 DISPLAY - ESEMPIO



5 COLLEGAMENTO PINZE A CAVI BATTERIA VEICOLO

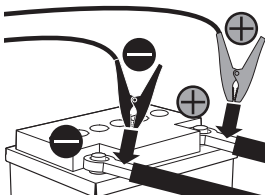

6 VEICOLO ALIMENTATO



RIMOZIONE BATTERIA

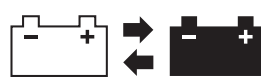

SOSTITUZIONE BATTERIA

7 USCITA MENU AVANZATO

FUNCTION



BLOCCO / SBLOCCO TASTIERA

BLOCCO

VOLT



MODE



DISPLAY



SBLOCCO

VOLT



MODE



DISPLAY



E AVVIAMENTO

START



1 SELEZIONE FUNZIONE

MODE



DISPLAY

START

2 SELEZIONE TENSIONE

VOLT



DISPLAY

12V 24V



Info Alarm

3 COLLEGAMENTO PINZE ALLA BATTERIA

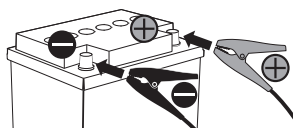

Info Alarm

DISPLAY

Go

4 AVVIAMENTO VEICOLO



5 TIMER 30" PER SUCCESSIVO START

DISPLAY

30
29
28

6 USCITA DA FUNZIONE

MODE



INFO ALLARMI



Info Alarm

AL 1

CORTO CIRCUITO

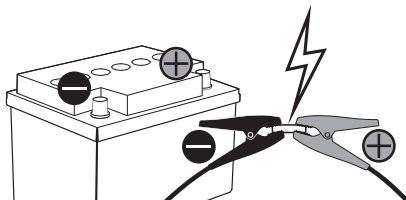

INVERSIONE POLARITÀ

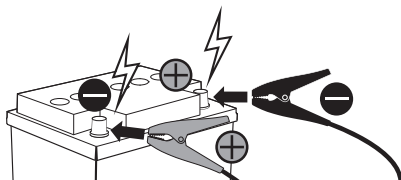

AL 2

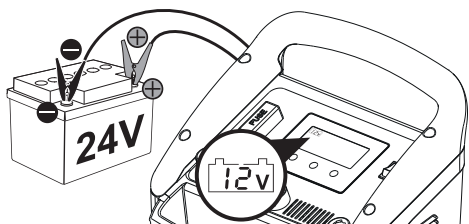

AL 4

AL 5

AL 6

AL 7

AL 8

Pulse Tronic



AL 9

CORTO CIRCUITO

EQUALIZATION

DIAGNOSTIC

SUPPLY

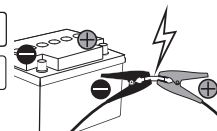

SEGNALAZIONE SURRISCALDAMENTO
Ripristino automatico

000

ALLARME TERMICO

0C

AFFICHEUR CL (pag. 2)

1. Tension de la batterie programmée.
2. Afficheur principal : tension-courant mesurée de batterie, Ah de sélection, valeur de tension sélectionnée pour les programmes Supply / Equalization, messages d'interface vers opérateur, codes d'alarme.
3. Alarme pour cause d'inversion polarité, court-circuit, batterie usée ou en avarie.
4. Courant et tension programmée.
Codes d'alarme "AL1 - AL9".
5. Niveau de charge de la batterie.
6. Choix courant de charge PULSE-TRONIC : AUTO, BOOST, Personnalisé (programmation Ah).
7. Fonctionnement en basses températures.
9. Modalité EQUALIZATION.
10. Modalité DESULFATION.
11. Choix typologie batterie :
WET: batteries au plomb, électrolyte liquide ;
GEL: batteries au plomb, cachetées, électrolyte solide ;
AGM: batteries au plomb, cachetées, électrolyte sur matériel absorbant ;
+ (CA): batteries au plomb calcium.
12. Modalité SUPPLY.
14. Phases charge PULSE-TRONIC.
15. Modalité START.
16. Modalité de charge automatique.
17. Charge en PULSE-TRONIC.
18. Test fonctionnement circuit de recharge (alternateur).
19. Test capacité démarrage batterie - CCA.
20. Test état de charge batterie.
21. VOLT - Bouton programmation :
- tension de batterie 12/24V ;
- réglage voltage /Ah.
22. FUNCTION - Bouton programmation :
- CHARGE PULSE -TRONIC (AUTO, AUTO ✱, WET, EFB, GEL, AGM +, Li) ;
- TEST (état batterie, alternateur véhicule, capacité démarrage batterie) ;
- Programmes Avancés (DESULFATION, EQUALIZATION, SUPPLY) ;
- réglage voltage /Ah.
23. MODE - Bouton programmation :
- courant de sortie (AUTO, BOOST, personnalisé) ;
- Modalité START.

FONCTIONS

- A. CHARGE PULSE TRONIC
- B. TEST
 - TEST ÉTAT DE CHARGE
 - TEST CAPACITÉ DÉMARRAGE BATTERIE (CCA)
 - TEST ALTERNATEUR
- C. ENTRETIEN BATTERIES
 - ÉQUALISATION
 - DÉSULFATION
- D. ALIMENTATION DE PUISSANCE (POWER SUPPLY)
 - ALIMENTATION
- E. DÉMARRAGE - START

INFOS ALARMES

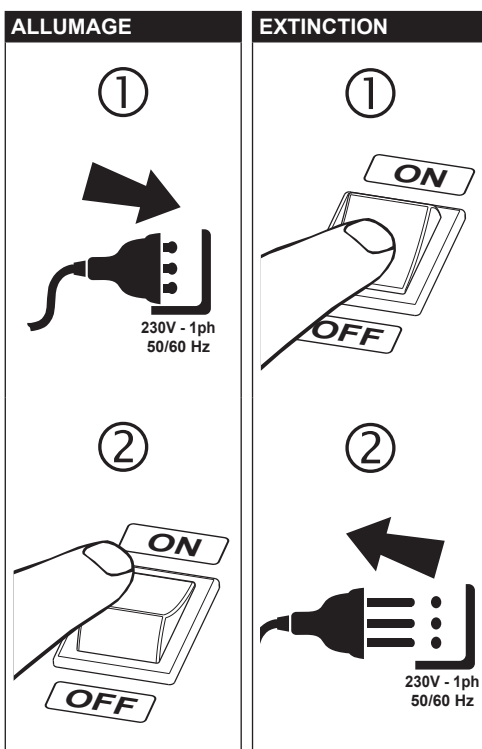

A CHARGE / MAINTIEN

TECHNOLOGIE PULSE-TRONIC

Pulse^{TRONIC}



1 SÉLECTION PULSE-TRONIC

FUNCTION



2 SÉLECTION TYPOLOGIE BATTERIE

FUNCTION

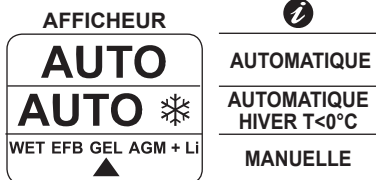

3 SÉLECTION COURANT

MODE

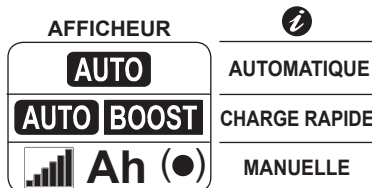

3A (●) PROGRAMMATION Ah - EXEMPLE

MODE

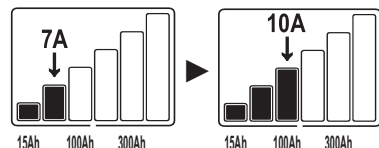

AFFICHEUR



VOLT



80Ah
75Ah
70Ah

FUNCTION



100Ah
95Ah
90Ah

4 SÉLECTION TENSION

VOLT



5 BRANCHEMENT PINCES

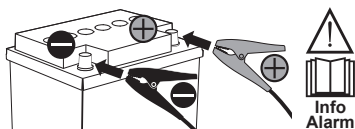

DÉMARRAGE APRÈS 5"

6 GRAPHIQUE PULSE-TRONIC

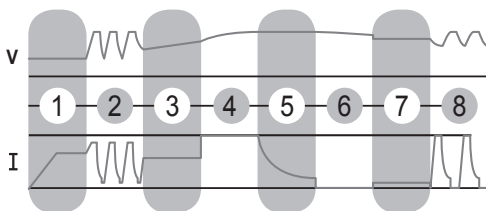

- 1 Test de batterie
- 2 Récupération batteries sulfatées / très déchargées
- 3 Contrôle intégrité
- 4 Chargée jusqu'à 80%
- 5 Chargée jusqu'à 100%
- 6 Dispositif de contrôle étanchéité charge
- 7 Maintien charge
- 8 Rétablissement de la charge par impulsions

7 FIN DE CHARGE - EXEMPLE



B TEST

ÉTAT DE CHARGE



1 SÉLECTION TEST

FUNCTION



AFFICHEUR

TEST



2 SÉLECTION TYPOLOGIE BATTERIE

FUNCTION



AFFICHEUR

WET EFB GEL AGM + Li



3 BRANCHEMENT PINCES

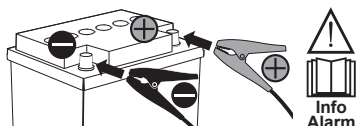

4 SÉLECTION TENSION

VOLT



AFFICHEUR

12V 24V



5 FIN TEST - EXEMPLE



LÉGENDE AFFICHEUR

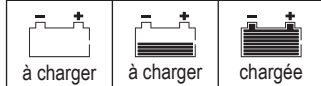

B TEST

CAPACITÉ DÉMARRAGE BATTERIE



1 SÉLECTION TEST

FUNCTION



AFFICHEUR

TEST



2 BRANCHEMENT PINCES

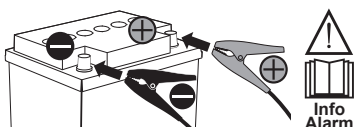

3 SÉLECTION TENSION

VOLT



AFFICHEUR

12V 24V



AFFICHEUR

Go

4 DÉMARRAGE VÉHICULE



5 FIN TEST - EXEMPLE



LÉGENDE AFFICHEUR



B TEST

ALTERNATEUR



1 SÉLECTION TEST

FUNCTION



AFFICHEUR



2 BRANCHEMENT PINCES

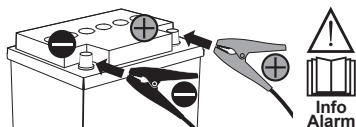

3 SÉLECTION TENSION

VOLT



AFFICHEUR

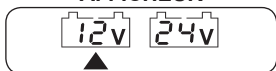

AFFICHEUR



4 DÉMARRAGE VÉHICULE



5 FIN TEST - EXEMPLE



LÉGENDE AFFICHEUR

OK	SUF	bAd
fonctionnant	suffisant	insuffisant

C ENTRETIEN

DÉSULFATATION

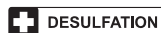

1 SÉLECTION MENU AVANCÉ

FUNCTION



MENU

ADVANCED PROGRAMS

2 SÉLECTION FONCTION

FUNCTION



AFFICHEUR

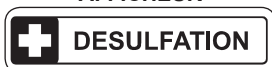

3 SÉLECTION TENSION BATTERIE

VOLT



AFFICHEUR

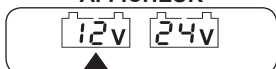

4 BRANCHEMENT PINCES

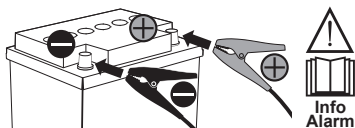

DÉMARRAGE APRÈS 5"

5 FIN PROCÈS - EXEMPLE



6 SORTIE MENU AVANCÉ

FUNCTION



C ENTRETIEN

ÉQUALISATION

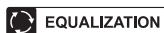

1 SÉLECTION MENU AVANCÉ

FUNCTION

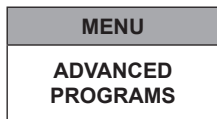

4 BRANCHEMENT PINCES

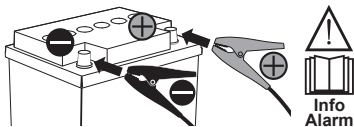

DÉMARRAGE APRÈS 5"

2 SÉLECTION FONCTION

FUNCTION



5 FIN PROCÈS - EXEMPLE

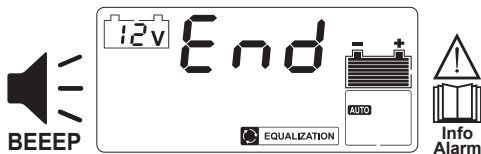

3 SÉLECTION TENSION BATTERIE

VOLT

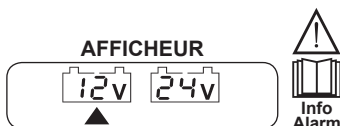

3A PERSONNALISATION TENSION - EXEMPLE



VÉRIFIER LE TYPE DE BATTERIE (WET, EFB, GEL, AGM +, Li) ET LA TENSION MAX. ADMISE.

VOLT



FUNCTION



3"

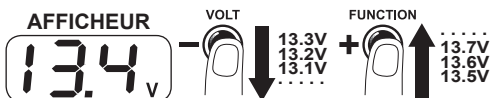

6 SORTIE MENU AVANCÉ

FUNCTION



BLOCAGE / DÉBLOCAGE CLAVIER

BLOCAGE

VOLT



MODE



AFFICHEUR

Lok on

DÉBLOCAGE

VOLT



MODE



AFFICHEUR

Lok off

D ALIMENTATION

ALIMENTATEUR

SUPPLY

CHANGEMENT BATTERIE

1 SÉLECTION MENU AVANCÉ

FUNCTION



3"



BEEEP

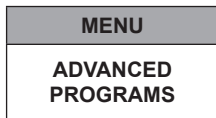

2 SÉLECTION FONCTION

FUNCTION



AFFICHEUR



PRÉSENCE TENSION ENTRE LES PINCES (MAX 27V).

3 SÉLECTION TENSION BATTERIE

VOLT



AFFICHEUR

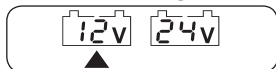

Info Alarm

3A PERSONNALISATION TENSION - EXEMPLE



VÉRIFIER D'APRÈS LES SPÉCIFICATIONS DU CONSTRUCTEUR DU VÉHICULE LA TENSION MAX. ADMISE.

VOLT



3"

FUNCTION



BEEEP

AFFICHEUR



VOLT



13.3V
13.2V
13.1V

FUNCTION



13.7V
13.6V
13.5V

3B PERSONNALISATION COURANT - EXEMPLE

MODE

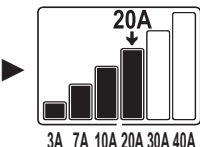
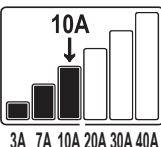

4 AFFICHEUR - EXEMPLE



SUPPLY

5 BRANCHEMENT PINCES À CÂBLES BATTERIE VÉHICULE

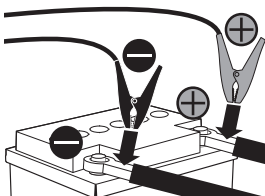

6 VÉHICULE ALIMENTÉ



EXTRACTION BATTERIE



SUBSTITUTION BATTERIE

7 SORTIE MENU AVANCÉ

FUNCTION



3"



BEEEP

BLOCAGE / DÉBLOCAGE CLAVIER

BLOCAGE

VOLT



MODE



AFFICHEUR

Lok on

DÉBLOCAGE

VOLT



MODE



AFFICHEUR

Lok off

E DÉMARRAGE

START



1 SÉLECTION FONCTION

MODE



AFFICHEUR

START

2 SÉLECTION TENSION

VOLT



AFFICHEUR

12V 24V



3 BRANCHEMENT PINCES À LA BATTERIE

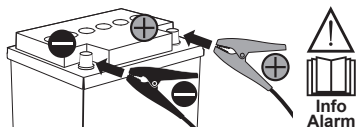

AFFICHEUR

00

4 DÉMARRAGE VÉHICULE



5 MINUTEUR 30" POUR DÉMARRAGE SUCCESSIF

AFFICHEUR

30
29
28

6 SORTIE DE LA FONCTION

MODE



INFOS ALARMES



Info Alarm

AL 1

COURT-CIRCUIT

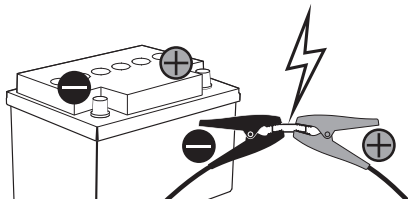

INVERSION DE POLARITÉ

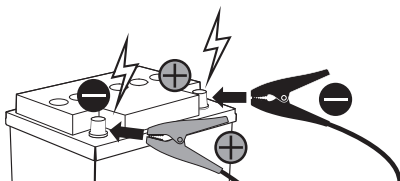

AL 2

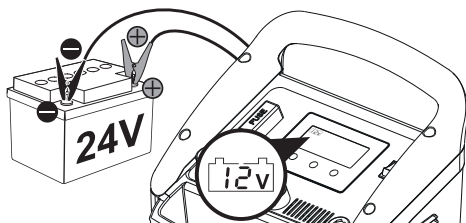

AL 4

AL 5

AL 6

AL 7

AL 8

Pulse *Tronic*



AL 9

COURT-CIRCUIT

EQUALIZATION

DIAGNOSTIC

SUPPLY

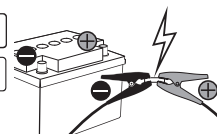

SIGNALISATION SURCHAUFFE Rétablissement automatique

ALARME THERMIQUE

000



00



DISPLAY LCD (pág. 2)

1. Tensión configurada para la batería.
2. Display principal: tensión-corriente medida de batería, Ah de selección, valor de tensión seleccionado para los programas Supply / Equalization, mensajes de interfaz hacia el operador, códigos de alarma.
3. Alarmas por inversión de polaridad, cortocircuito, batería desgastada o averiada.
4. Corriente y tensión que se han configurado. Códigos de alarma "AL1 - AL9".
5. Nivel de carga de la batería.
6. Elección de la corriente de carga PULSE-TRONIC: AUTO, BOOST, Personalizada (configuración Ah).
7. Funcionamiento con bajas temperaturas.
9. Modalidad EQUALIZATION.
10. Modalidad DESULFATION.
11. Elección tipo de batería:
WET: baterías de plomo, electrolito líquido;
GEL: batería de plomo, electrolito sólido;
AGM: baterías de plomo, selladas, electrolito sobre material absorbente;
+ (CA);baterías de plomo calcio.
12. Modalidad SUPPLY.
14. Fases de carga PULSE-TRONIC.
15. Modalidad START.
16. Modalidad de carga automática
17. Carga en PULSE-TRONIC.
18. Prueba de funcionamiento del circuito de recarga (alternador).
19. Prueba capacidad de carga batería - CCA.
20. Prueba de estado de carga batería.
21. VOLT - Pulsador de configuración:
- tensión de batería 12/24V;
- regulación tensión/Ah.
22. FUNCTION- Pulsador de configuración:
- CARGA PULSE -TRONIC (AUTO, AUTO *, WET, EFB, GEL, AGM +, Li);
- TEST (estado de batería, alternador vehículo, capacidad arranque batería);
- Programas Avanzados (DESULFATION, EQUALIZATION, SUPPLY);
- regulación tensión/Ah.
23. MODE - Pulsador configuración:
- corriente de salida (AUTO, BOOST, personalizada);
- Modalidad START.

FUNCIONES

- A. CARGA PULSE TRONIC
- B. PRUEBA
 - PRUEBA ESTADO DE CARGA
 - PRUEBA CAPACIDAD ARRANQUE BATERÍA (CCA)
 - PRUEBA ALTERNADOR
- C. MANTENIMIENTO BATERÍAS
 - ECUALIZACIÓN
 - DESULFATACIÓN
- D. ALIMENTACIÓN DE POTENCIA (POWER SUPPLY)
 - ALIMENTACIÓN
- E. ARRANQUE - START

INFO ALARMAS

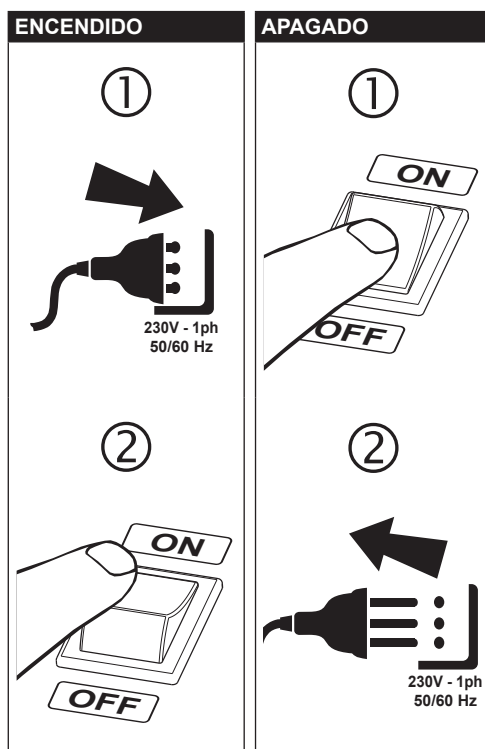

A CARGA/TRATAMIENTO

TECNOLOGÍA PULSE-TRONIC

Pulse TRONIC
Tronic



1 SELECCIÓN PULSE-TRONIC

FUNCTION



2 SELECCIÓN TIPOLOGÍA BATERÍA

FUNCTION

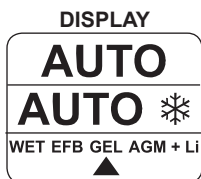

3 SELECCIÓN CORRIENTE

MODE

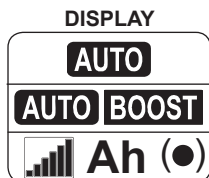

3A (●) CONFIGURACIÓN Ah - EJEMPLO

MODE

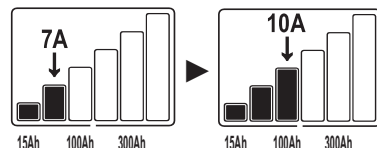

VOLT



80Ah
75Ah
70Ah

FUNCTION



100Ah
95Ah
90Ah

4 SELECCIÓN TENSIÓN

VOLT

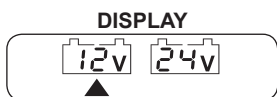

5 CONEXIÓN PINZAS

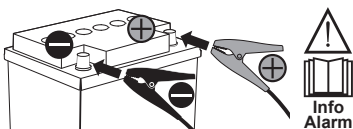

ARRANQUE DESPUÉS DE 5"

6 GRÁFICO PULSE-TRONIC

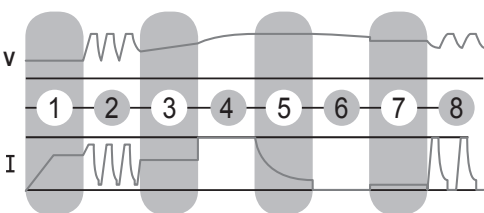

- 1 Prueba de batería
- 2 Recuperación baterías sulfatadas/muy descargadas
- 3 Control de la integridad
- 4 Carga hasta el 80%
- 5 Carga hasta el 100%
- 6 Monitoreo retención carga
- 7 Mantenimiento carga
- 8 Restablecimiento carga a impulsos

7 FIN DE CARGA - EJEMPLO



B PRUEBA

ESTADO DE CARGA



1 SELECCIÓN PRUEBA

FUNCTION



DISPLAY
TEST



2 SELECCIÓN TIPOLOGÍA BATERÍA

FUNCTION



DISPLAY
WET EFB GEL AGM + Li



3 CONEXIÓN PINZAS

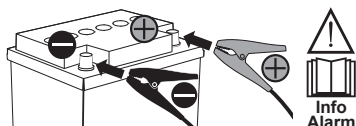

4 SELECCIÓN TENSIÓN

VOLT



DISPLAY

12V 24V



5 FIN DE PRUEBA - EJEMPLO



LEYENDA DISPLAY



B PRUEBA

CAPACIDAD ARRANQUE BATERÍA



1 SELECCIÓN PRUEBA

FUNCTION



DISPLAY
TEST



2 CONEXIÓN PINZAS

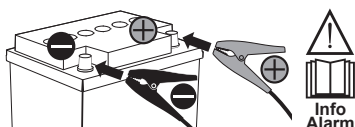

3 SELECCIÓN TENSIÓN

VOLT



DISPLAY

12V 24V



DISPLAY

Go

4 ARRANQUE VEHÍCULO



5 FIN DE PRUEBA - EJEMPLO



LEYENDA DISPLAY



B PRUEBA

ALTERNADOR



1 SELECCIÓN PRUEBA

FUNCTION

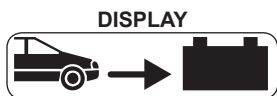

DISPLAY

2 CONEXIÓN PINZAS

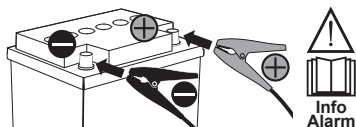

3 SELECCIÓN TENSIÓN

VOLT

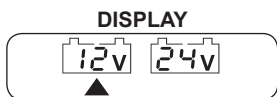

DISPLAY



DISPLAY

4 ARRANQUE VEHÍCULO



5 FIN DE PRUEBA - EJEMPLO



LEYENDA DISPLAY

OK	SUF	bAd
en función	suficiente	insuficiente

C MANTENIMIENTO

DESULFATACIÓN

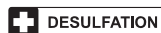

1 SELECCIÓN MENÚ AVANZADO

FUNCTION



3"

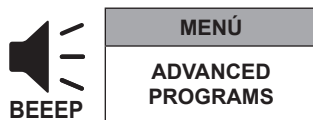

2 SELECCIÓN FUNCIÓN

FUNCTION



DISPLAY

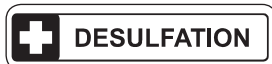

3 SELECCIÓN TENSIÓN BATERÍA

VOLT

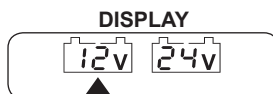

DISPLAY



4 CONEXIÓN PINZAS

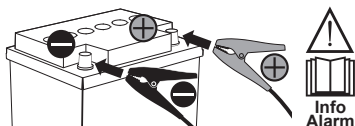

ARRANQUE DESPUÉS DE 5"

5 FIN DE PROCESO - EJEMPLO



6 SALIDA MENÚ AVANZADO

FUNCTION



3"

BEEEP

C MANTENIMIENTO

ECUALIZACIÓN

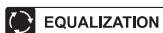

1 SELECCIÓN MENÚ AVANZADO

FUNCTION



2 SELECCIÓN FUNCIÓN

FUNCTION



3 SELECCIÓN TENSIÓN BATERÍA

VOLT

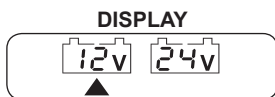

3A PERSONALIZACIÓN TENSIÓN - EJEMPLO



CONTROLAR EL TIPO DE BATERÍA (WET, EFB, GEL, AGM +, Li) Y LA MÁX. TENSIÓN ADMITIDA.

VOLT



FUNCTION

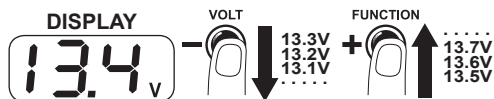

4 CONEXIÓN PINZAS

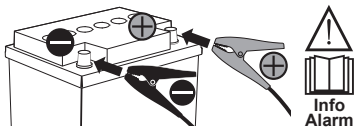

ARRANQUE DESPUÉS DE 5"

5 FIN DE PROCESO - EJEMPLO

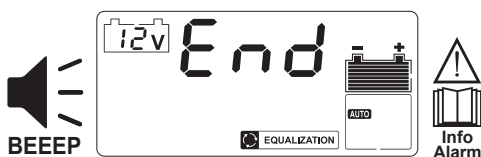

6 SALIDA MENÚ AVANZADO

FUNCTION



BLOQUEO/DESBLOQUEO DEL TECLADO

BLOQUEO

VOLT



MODE



DISPLAY



DESBLOQUEO

VOLT



MODE



DISPLAY



D ALIMENTACIÓN

ALIMENTADOR

SUPPLY

CAMBIO BATERÍA

1 SELECCIÓN MENÚ AVANZADO

FUNCTION

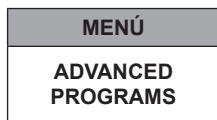

2 SELECCIÓN FUNCIÓN

FUNCTION



DISPLAY



PRESENCIA DE TENSIÓN ENTRE LAS PINZAS (MAX 27V).

3 SELECCIÓN TENSIÓN BATERÍA

VOLT



DISPLAY

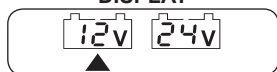

3A PERSONALIZACIÓN TENSIÓN - EJEMPLO



CONTROLAR LAS ESPECIFICACIONES DEL CONSTRUCTOR DEL VEHÍCULO LA MÁXIMA TENSIÓN ADMITIDA. CONSULTANDO LAS

VOLT



FUNCTION



3"

DISPLAY



VOLT



13.3V
13.2V
13.1V

FUNCTION



13.7V
13.6V
13.5V

3B PERSONALIZACIÓN CORRIENTE - EJEMPLO

MODE

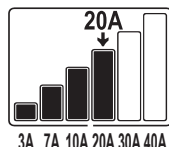
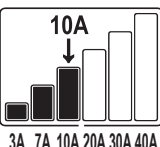

4 DISPLAY - EJEMPLO



5 CONEXIÓN DE LAS PINZAS A LOS CABLES BATERÍA DEL VEHÍCULO

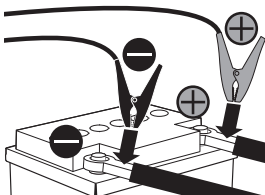

6 VEHÍCULO ALIMENTADO



REMOCIÓN DE LA BATERÍA

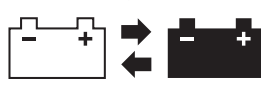

SUSTITUCIÓN DE LA BATERÍA

7 SALIDA MENÚ AVANZADO

FUNCTION



BLOQUEO / DESBLOQUEO DEL TECLADO

BLOQUEO

VOLT



MODE



DISPLAY



DESBLOQUEO

VOLT



MODE



DISPLAY



E ARRANQUE

START



1 SELECCIÓN FUNCIÓN

MODE



DISPLAY

START

2 SELECCIÓN TENSIÓN

VOLT



DISPLAY

12V 24V



3 CONEXIÓN DE LAS PINZAS A LA BATERÍA

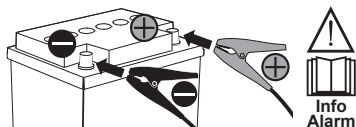

DISPLAY

00

4 ARRANQUE VEHÍCULO



5 TEMPORIZADOR 30" PARA EL ARRANQUE SUCESIVO

DISPLAY

30
29
28

6 SALIDA DE FUNCIÓN

MODE



INFO ALARMAS



AL 1

CORTO CIRCUITO

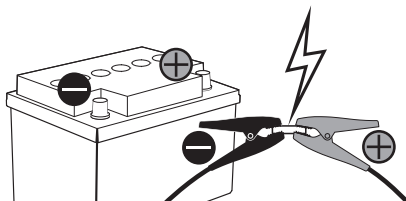

INVERSIÓN POLARIDAD

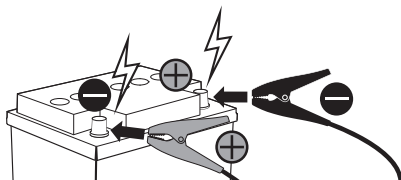

AL 2

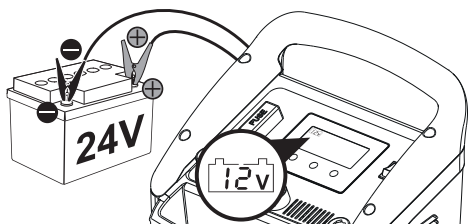

AL 4

AL 5

AL 6

AL 7

AL 8

Pulse *Tronic*



AL 9

CORTO CIRCUITO

EQUALIZATION

DIAGNOSTIC

SUPPLY

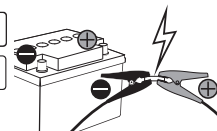

SEÑALACIÓN SOBRECALENTAMIENTO Restablecimiento automático

ALARMA TÉRMICA

000



00



LCD-DISPLAY (s. 2)

1. Eingestellte Batteriespannung.
2. Hauptdisplay: Gemessene Spannung - Strom der Batterie, Einstellwert Ah, eingestellter Spannungswert für die Programme Supply / Equalization, Meldungen auf der Bedieneroberfläche, Alarmcodes.
3. Alarm wegen vertauschter Polung, Kurzschluss, verbrauchter oder schadhafter Batterie.
4. Einstellwerte für Strom und Spannung. Alarmcodes „AL1 - AL9“.
5. Ladestand der Batterie.
6. Einstellung Ladestrom PULSE-TRONIC: AUTO, BOOST, individuell (Einstellung Ah).
7. Betrieb bei niedrigen Temperaturen.
9. Modus EQUALIZATION.
10. Modus DESULFATION.
11. Einstellung Batterietyp:
 - WET: Bleibatterien, Flüssigelektrolyt;
 - GEL: Bleibatterien, versiegelt, Festelektrolyt;
 - AGM: Bleibatterien, versiegelt, Elektrolyt auf absorbierendem Material;
 - + (CA): Blei-Calcium-Batterien.
12. Modus SUPPLY.
14. Ladephasen PULSE-TRONIC.
15. Modus START.
16. Modus für automatisches Laden.
17. Laden im Modus PULSE-TRONIC.
18. Funktionstest Aufladekreislauf (Drehstromlichtmaschine).
19. Test Startleistung Batterie - CCA.
20. Test Ladezustand Batterie.
21. VOLT - Knopf für die Einstellung:
 - Batteriespannung 12/24V;
 - Spannungsregulierung /Ah.
22. FUNCTION - Knopf für die Einstellung:
 - LADEN PULSE -TRONIC (AUTO, AUTO * , WET, EFB, GEL, AGM +, Li);
 - TEST (Batteriezustand, Drehstromlichtmaschine Fahrzeug, Startleistung Batterie);
 - Erweiterte Programme (DESULFATION, EQUALIZATION, SUPPLY);
 - Spannungsregulierung /Ah.
23. MODE - Knopf für die Einstellung:
 - Ausgangsstrom (AUTO, BOOST, individuell);
 - Modus START.

FUNKTIONEN

- A. LADEN PULSE TRONIC
- B. TEST
 - TEST LADEZUSTAND
 - TEST STARTLEISTUNG BATTERIE (CCA)
 - TEST DREHSTROMLICHTMASCHINE
- C. BATTERIEWARTUNG
 - AUSGLEICHSLADUNG
 - DESULFATIERUNG
- D. LEISTUNGSVERSORGUNG (POWER SUPPLY)
 - SPANNUNGSVERSORGUNG
- E. STARTEN - START

ALARMINFORMATIONEN

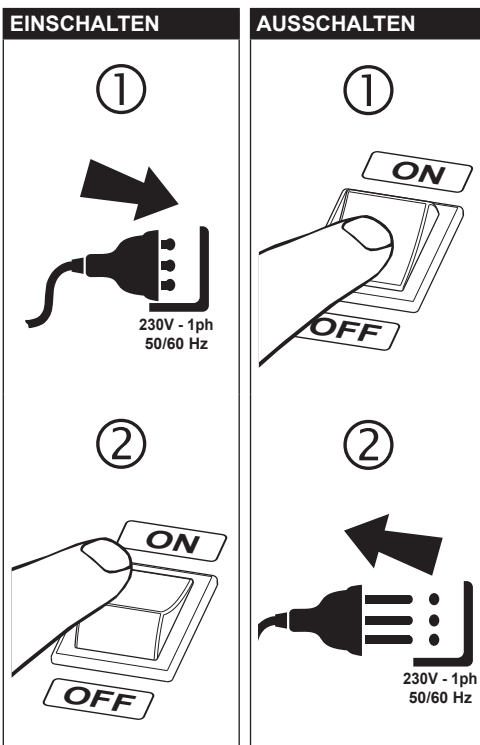

A LADEN / ERHALTUNGSLADEN

TECHNOLOGIE PULSE-TRONIC *Pulse^{TRONIC}*



1 AUSWAHL PULSE-TRONIC

FUNCTION



2 EINSTELLUNG BATTERIETYP

FUNCTION



3 EINSTELLUNG STROM

MODE

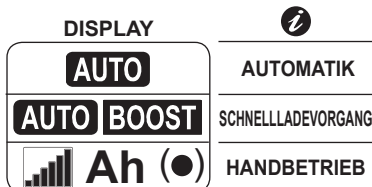

3A (●) EINSTELLUNG Ah - BEISPIEL

MODE

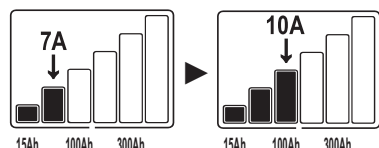

VOLT



80Ah
75Ah
70Ah

FUNCTION



100Ah
95Ah
90Ah

4 EINSTELLUNG SPANNUNG

VOLT

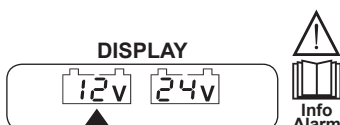

5 ANSCHLUSS ZANGEN

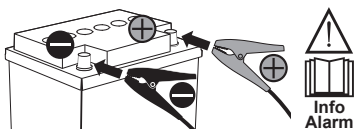

START NACH 5 SEKUNDEN

6 GRAFIK PULSE-TRONIC

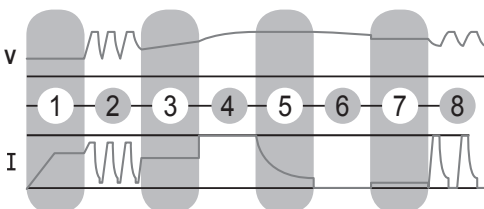

- 1 Batterietest
- 2 Instandsetzung sulfatierter / stark entladener Batterien
- 3 Prüfung auf einwandfreien Funktionszustand
- 4 Laden auf 80%
- 5 Laden auf 100%
- 6 Überwachung Ladungserhaltung
- 7 Erhaltungsladung
- 8 Impulsweises Nachladen

7 ENDE LADEVORGANG - BEISPIEL



B TEST

LADEZUSTAND



1 AUSWAHL TEST

FUNCTION



DISPLAY
TEST



2 EINSTELLUNG BATTERIETYP

FUNCTION



DISPLAY
WET EFB GEL AGM + Li



3 ANSCHLUSS ZANGEN

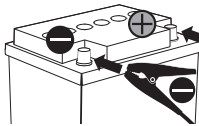

4 EINSTELLUNG SPANNUNG

VOLT



DISPLAY

12V 24V



5 ENDE TEST - BEISPIEL



14.1 V

GEL



ZEICHENERKLÄRUNG DISPLAY



zu laden



zu laden



aufgeladen

B TEST

STARTLEISTUNG BATTERIE



1 AUSWAHL TEST

FUNCTION



DISPLAY
TEST



2 ANSCHLUSS ZANGEN

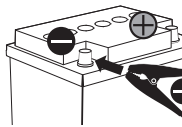

3 EINSTELLUNG SPANNUNG

VOLT



DISPLAY

12V 24V



DISPLAY

Go

4 FAHRZEUGSTART



5 ENDE TEST - BEISPIEL



OK

ZEICHENERKLÄRUNG DISPLAY

OK

funktionstüchtig

SUF

ausreichend

bAd

nicht ausreichend

B TEST

DREHSTROMLICHTMASCHINE →

1 AUSWAHL TEST

FUNCTION

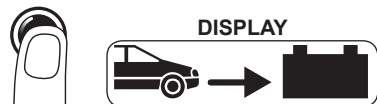

2 ANSCHLUSS ZANGEN

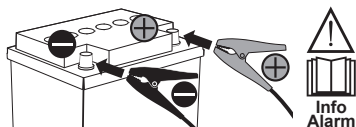

3 EINSTELLUNG SPANNUNG

VOLT

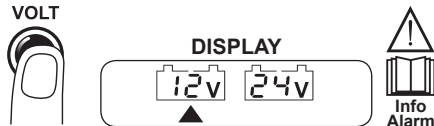

DISPLAY



4 FAHRZEUGSTART



5 ENDE TEST - BEISPIEL



ZEICHENERKLÄRUNG DISPLAY

OK funktionstüchtig	SUF ausreichend	bAd nicht ausreichend
-------------------------------	---------------------------	---------------------------------

C WARTUNG

DESULFATIERUNG DESULFATION

1 AUFRUFEN ERWEITERTES MENÜ

FUNCTION



2 AUSWAHL FUNKTION

FUNCTION



3 EINSTELLUNG BATTERIESPANNUNG

VOLT

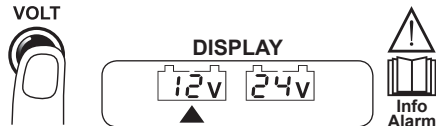

4 ANSCHLUSS ZANGEN

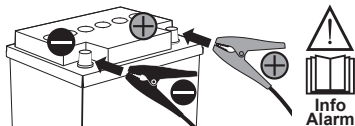

START NACH 5 SEKUNDEN

5 ENDE VORGANG - BEISPIEL

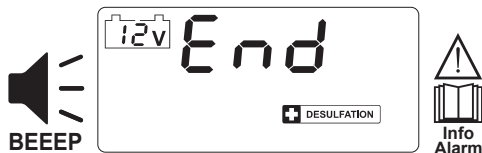

6 VERLASSEN ERWEITERTES MENÜ

FUNCTION



C WARTUNG

AUSGLEICHLADUNG EQUALIZATION

1 AUFRUFEN ERWEITERTES MENÜ

FUNCTION

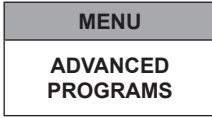

2 AUSWAHL FUNKTION

FUNCTION



3 EINSTELLUNG BATTERIESPANNUNG

VOLT

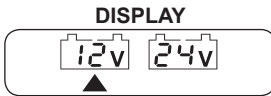

3A INDIVIDUELLE EINSTELLUNG DER SPANNUNG - BEISPIEL



DEN BATTERIETYP (WET, EFB, GEL, AGM +, Li) UND DIE MAX. ZULÄSSIGE SPANNUNG PRÜFEN.

VOLT



FUNCTION

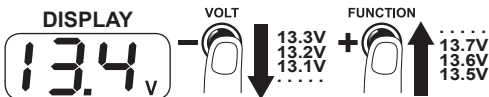

4 ANSCHLUSS ZANGEN

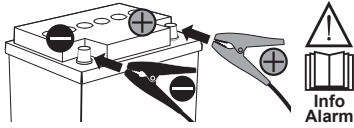

START NACH 5 SEKUNDEN

5 ENDE VORGANG - BEISPIEL

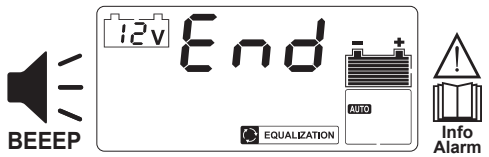

6 VERLASSEN ERWEITERTES MENÜ

FUNCTION



SPERREN / ENTPERREN TASTATUR

SPERREN

VOLT



MODE



DISPLAY



ENTSPERREN

VOLT



MODE



DISPLAY



D SPANNUNGSVERSORGUNG

NETZTEIL

SUPPLY

BATTERIEWECHSEL

1 AUFRUFEN ERWEITERTES MENÜ

FUNCTION

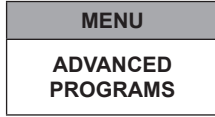

2 AUSWAHL FUNKTION

FUNCTION



DISPLAY



ANLIEGENDE SPANNUNG ZWISCHEN DEN ZANGEN (MAX 27V).

3 EINSTELLUNG BATTERIESPANNUNG

VOLT



DISPLAY

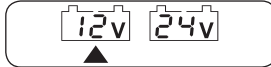

3A INDIVIDUELLE EINSTELLUNG DER SPANNUNG - BEISPIEL



IN DEN ANGABEN DES FAHRZEUGHERSTELLERS DIE MAXIMAL ZULÄSSIGE SPANNUNG PRÜFEN.

VOLT



FUNCTION



DISPLAY



VOLT



13.3V
13.2V
13.1V
.....

FUNCTION



13.7V
13.6V
13.5V
.....

3B INDIVIDUELLE EINSTELLUNG DES STROMS - BEISPIEL

MODE

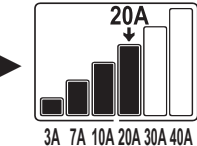
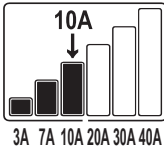

4 DISPLAY - BEISPIEL



5 ANSCHLUSS ZANGEN AN KABEL FAHRZEUGBATTERIE

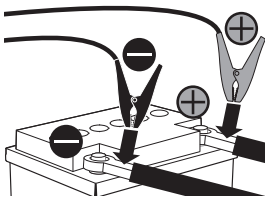

6 GESPEISTES FAHRZEUG



ENTFERNEN DER BATTERIE



AUSTAUSCH DER BATTERIE

7 VERLASSEN ERWEITERTES MENÜ

FUNCTION



SPERREN / ENTPERREN TASTATUR

SPERREN

VOLT



MODE



DISPLAY



ENTSPERREN

VOLT



MODE



DISPLAY

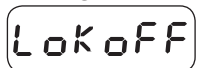

E STARTEN

START

12v

1 AUSWAHL FUNKTION

MODE



DISPLAY

START

2 EINSTELLUNG SPANNUNG

VOLT



DISPLAY

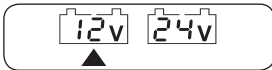

3 ANSCHLUSS ZANGEN AN DIE BATTERIE

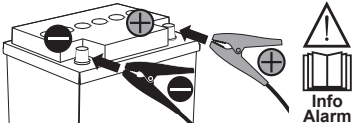

DISPLAY

Go

4 FAHRZEUGSTART



5 SCHALTUHR 30 SEKUNDEN FÜR ANSCHLIESSENDEN START

DISPLAY

30
29
28

6 VERLASSEN DER FUNKTION

MODE



ALARMINFORMATIONEN



Info Alarm

AL 1

KURZSCHLUSS

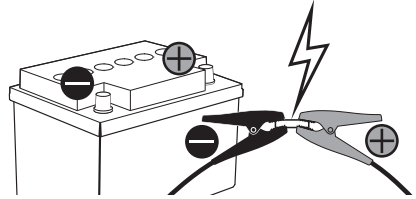

VERTAUSCHTE POLUNG

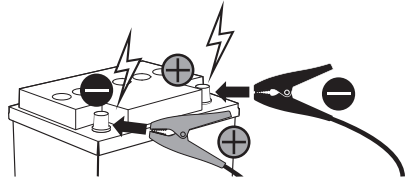

AL 2

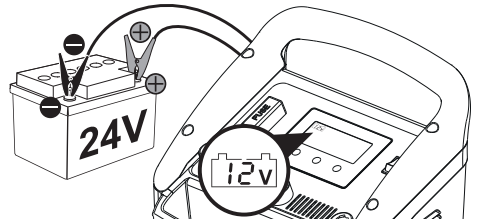

AL 4

AL 5

AL 6

AL 7

AL 8

Pulse *mm*
Tronic



AL 9

KURZSCHLUSS

EQUALIZATION

DIAGNOSTIC

SUPPLY

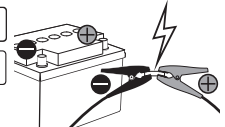

ANZEIGE
ÜBERHITZUNG
Automatische
Rückstellung

000



THERMO-
ALARM

00



ЖИДКОКРИСТАЛЛИЧЕСКИЙ ДИСПЛЕЙ (стр. 2)

ФУНКЦИИ

1. Напряжение аккумулятора установлено.
2. Главный дисплей: измеренное напряжение/ ток аккумулятора, выбранное значение Ач, значение напряжения, выбранного для программ Supply / Equalization, сообщения на операторском интерфейсе, коды сигналов тревоги.
3. Сигнал тревоги из-за нарушения полярности, короткого замыкания, износившегося или поврежденного аккумулятора.
4. Установленный ток и напряжение. Коды сигналов тревоги "AL1 - AL9".
5. Уровень заряда аккумулятора.
6. Выбор зарядного тока PULSE-TRONIC: AUTO, BOOST, Настроенный (установка Ah).
7. Работа в условиях низкой температуры.
9. Режим EQUALIZATION.
10. Режим DESULFATION.
11. Выбор типа аккумулятора:
WET: свинцовые аккумуляторы с жидким электролитом;
GEL: свинцовые аккумуляторы, герметичные, с твердым электролитом;
AGM: свинцовые аккумуляторы, герметичные, с электролитом в абсорбенте;
+ (CA): свинцово-кальциевый аккумулятор.
12. Режим SUPPLY.
14. Фазы зарядки PULSE-TRONIC.
15. Режим START.
16. Режим автоматической зарядки.
17. Зарядка в режиме PULSE-TRONIC.
18. Проверка исправности цепи зарядки (генератор).
19. Проверка пусковой способности аккумулятора - CCA.
20. Проверка состояния заряда аккумулятора.
21. VOLT - Кнопка установки:
- напряжение аккумулятора 12/24V;
- регулировка напряжения/Ah.
22. FUNCTION - Кнопка установки:
- ЗАРЯДКА PULSE -TRONIC (AUTO, AUTO ^{*}, WET, EFB, GEL, AGM +, Li);
- TEST (состояние аккумулятора, генератор транспортного средства, пусковая способность аккумулятора);
- Расширенные программы (DESULFATION, EQUALIZATION, SUPPLY);
- регулировка напряжения/Ah.
23. MODE - Кнопка установки:
- выходной ток (AUTO, BOOST, настроенный);
- Режим START.

- A. ЗАРЯДКА PULSE TRONIC
- B. ПРОВЕРКА
 - ПРОВЕРКА СОСТОЯНИЯ ЗАРЯДА
 - ПРОВЕРКА ПУСКОВОЙ СПОСОБНОСТИ АККУМУЛЯТОРА (CCA)
 - ПРОВЕРКА ГЕНЕРАТОРА
- C. ОБСЛУЖИВАНИЕ АККУМУЛЯТОРА
 - ВЫРАВНИВАНИЕ
 - ДЕСУЛЬФАТАЦИЯ
- D. ИСТОЧНИК ПИТАНИЯ (POWER SUPPLY)
 - ПИТАНИЕ
- E. ЗАПУСК - START

ИНФОРМАЦИЯ О СИГНАЛАХ ТРЕВОГИ

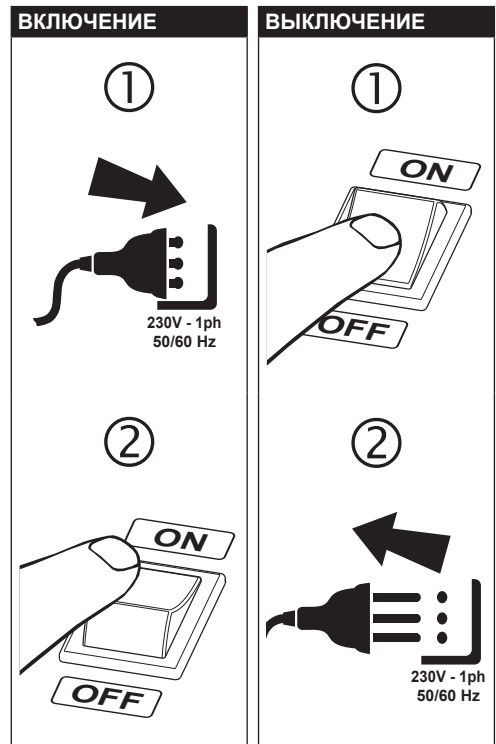

A ЗАРЯДКА/ПОДДЕРЖКА

ТЕХНОЛОГИЯ PULSE-TRONIC

Pulse lll
Tronic



1 ВЫБОР PULSE-TRONIC

FUNCTION



ДИСПЛЕЙ

Pulse lll
Tronic

2 ВЫБОР ТИПА АККУМУЛЯТОРА

FUNCTION



ДИСПЛЕЙ

AUTO

AUTO ❄️

WET EFB GEL AGM + Li



АВТОМАТИЧЕСКИЙ

АВТОМАТИЧЕСКИЙ
ЗИМА T < 0°C

РУЧНОЙ

3 ВЫБОР ТОКА

MODE



ДИСПЛЕЙ

AUTO

AUTO BOOST

Ah (●)



АВТОМАТИЧЕСКИЙ

БЫСТРАЯ
ЗАРЯДКА

РУЧНОЙ

3A (●) УСТАНОВКА Ач - ПРИМЕР

MODE

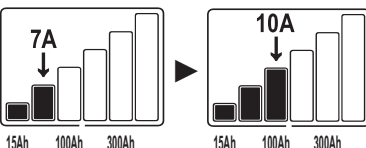

ДИСПЛЕЙ
85 Ah

VOLT



80Ah
75Ah
70Ah

FUNCTION



100Ah
95Ah
90Ah

4 ВЫБОР НАПРЯЖЕНИЯ

VOLT



ДИСПЛЕЙ

12v 24v



5 ПОДКЛЮЧЕНИЕ ЗАЖИМОВ

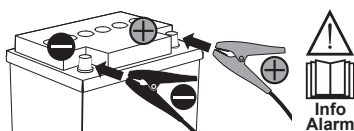

ЗАПУСК ЧЕРЕЗ 5 СЕКУНД

6 ГРАФИК PULSE-TRONIC

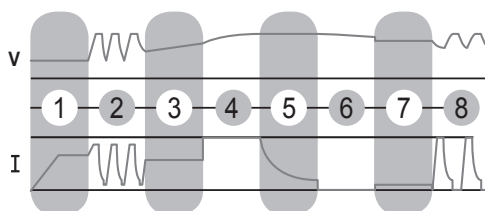

- 1 Проверка аккумулятора
- 2 Восстановление сульфатированных / глубоко разряженных аккумуляторов
- 3 Проверка целостности
- 4 Зарядка до 80%
- 5 Зарядка до 100%
- 6 Контроль удержания заряда
- 7 Поддержание заряда
- 8 Импульсное восстановление заряда

7 КОНЕЦ ЗАРЯДА - ПРИМЕР



В ПРОВЕРКА

СОСТОЯНИЕ ЗАРЯДА



1 ВЫБОР ПРОВЕРКИ

FUNCTION



ДИСПЛЕЙ
TEST



2 ВЫБОР ТИПА АККУМУЛЯТОРА

FUNCTION



ДИСПЛЕЙ
WET EFB GEL AGM + Li



3 ПОДКЛЮЧЕНИЕ ЗАЖИМОВ

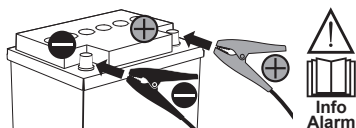

4 ВЫБОР НАПРЯЖЕНИЯ

VOLT



5 КОНЕЦ ПРОВЕРКИ - ПРИМЕР



УСЛОВНЫЕ ОБОЗНАЧЕНИЯ НА ДИСПЛЕЕ



В ПРОВЕРКА

ПУСКОВАЯ СПОСОБНОСТЬ АККУМУЛЯТОРА



1 ВЫБОР ПРОВЕРКИ

FUNCTION



ДИСПЛЕЙ
TEST



2 ПОДКЛЮЧЕНИЕ ЗАЖИМОВ

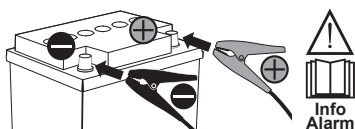

3 ВЫБОР НАПРЯЖЕНИЯ

VOLT



ДИСПЛЕЙ



4 ЗАПУСК АВТОМОБИЛЯ



5 КОНЕЦ ПРОВЕРКИ - ПРИМЕР



УСЛОВНЫЕ ОБОЗНАЧЕНИЯ НА ДИСПЛЕЕ



В ПРОВЕРКА

ГЕНЕРАТОР



1 ВЫБОР ПРОВЕРКИ

FUNCTION



ДИСПЛЕЙ



2 ПОДКЛЮЧЕНИЕ ЗАЖИМОВ

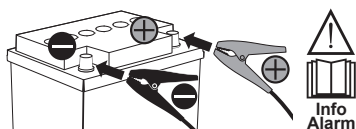

3 ВЫБОР НАПРЯЖЕНИЯ

VOLT



ДИСПЛЕЙ

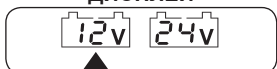

ДИСПЛЕЙ



4 ЗАПУСК АВТОМОБИЛЯ



5 КОНЕЦ ПРОВЕРКИ - ПРИМЕР



УСЛОВНЫЕ ОБОЗНАЧЕНИЯ НА ДИСПЛЕЕ

OK	SUF	bAd
работоспособный	достаточный	недостаточный

С ОБСЛУЖИВАНИЕ

ДЕСУЛЬФАТАЦИЯ

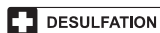

1 ВЫБОР РАСШИРЕННОГО МЕНЮ

FUNCTION



MENU

ADVANCED PROGRAMS

2 ВЫБОР ФУНКЦИИ

FUNCTION



ДИСПЛЕЙ

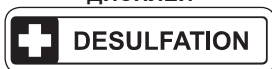

3 ВЫБОР НАПРЯЖЕНИЯ АККУМУЛЯТОРА

VOLT



ДИСПЛЕЙ

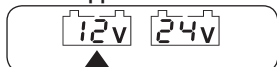

4 ПОДКЛЮЧЕНИЕ ЗАЖИМОВ

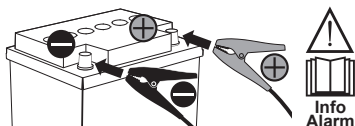

ЗАПУСК ЧЕРЕЗ 5 СЕКУНД

5 КОНЕЦ ПРОЦЕССА - ПРИМЕР



6 ВЫХОД ИЗ РАСШИРЕННОГО МЕНЮ

FUNCTION



С ОБСЛУЖИВАНИЕ

ВЫРАВНИВАНИЕ

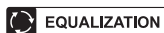

1 ВЫБОР РАСШИРЕННОГО МЕНЮ

FUNCTION



2 ВЫБОР ФУНКЦИИ

FUNCTION



3 ВЫБОР НАПРЯЖЕНИЯ АККУМУЛЯТОРА

VOLT



3А НАСТРОЙКА НАПРЯЖЕНИЯ - ПРИМЕР



ПРОВЕРЬТЕ ТИП АККУМУЛЯТОРА (WET, EFB, GEL, AGM +, Li) И МАКС. ДОПУСТИМОЕ НАПРЯЖЕНИЕ.

VOLT

FUNCTION

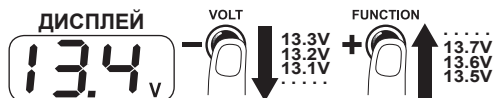

4 ПОДКЛЮЧЕНИЕ ЗАЖИМОВ

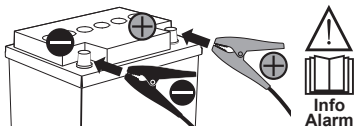

ЗАПУСК ЧЕРЕЗ 5 СЕКУНД

5 КОНЕЦ ПРОЦЕССА - ПРИМЕР

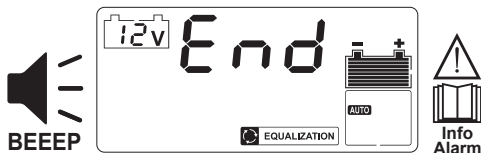

6 ВЫХОД ИЗ РАСШИРЕННОГО МЕНЮ

FUNCTION



БЛОКИРОВКА/РАЗБЛОКИРОВКА КЛАВИАТУРЫ

БЛОКИРОВКА

VOLT

MODE



ДИСПЛЕЙ

Lok on

РАЗБЛОКИРОВКА

VOLT

MODE



ДИСПЛЕЙ

Lok off

D ПИТАНИЕ

БЛОК ПИТАНИЯ

SUPPLY

ЗАМЕНА АККУМУЛЯТОРА

1 ВЫБОР РАСШИРЕННОГО МЕНЮ

FUNCTION

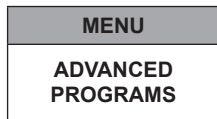

2 ВЫБОР ФУНКЦИИ

FUNCTION



ДИСПЛЕЙ



НАЛИЧИЕ ТОКА МЕЖДУ ЗАЖИМАМИ (MAX 27 В).

3 ВЫБОР НАПРЯЖЕНИЯ АККУМУЛЯТОРА

VOLT



ДИСПЛЕЙ

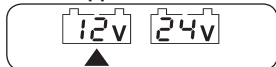

3A НАСТРОЙКА НАПРЯЖЕНИЯ - ПРИМЕР



ИНФОРМАЦИЮ О МАКС. ДОПУСТИМОМ НАПРЯЖЕНИИ СМ. В СПЕЦИФИКАЦИИ ИЗГОТОВИТЕЛЯ.

VOLT



FUNCTION



3"

БЕЕЕЕ

ДИСПЛЕЙ



VOLT



13.3V
13.2V
13.1V

FUNCTION



13.7V
13.6V
13.5V

3B НАСТРОЙКА ТОКА - ПРИМЕР

MODE

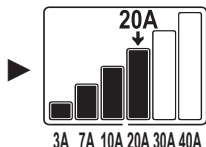
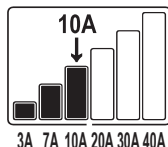

4 ДИСПЛЕЙ - ПРИМЕР



SUPPLY

5 ПОДКЛЮЧЕНИЕ ЗАЖИМОВ К КАБЕЛЯМ АККУМУЛЯТОРА ТРАНСПОРТНОГО СРЕДСТВА

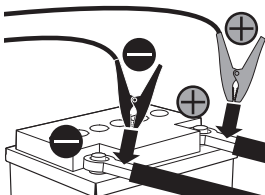

6 ПИТАНИЕ ТРАНСПОРТНОГО СРЕДСТВА ВКЛЮЧЕНО



ИЗВЛЕЧЕНИЕ АККУМУЛЯТОРА



ЗАМЕНА АККУМУЛЯТОРА

7 ВЫХОД ИЗ РАСШИРЕННОГО МЕНЮ

FUNCTION



3"

БЕЕЕЕ

БЛОКИРОВКА/РАЗБЛОКИРОВКА КЛАВИАТУРЫ

БЛОКИРОВКА

VOLT



MODE



ДИСПЛЕЙ



РАЗБЛОКИРОВКА

VOLT



MODE



ДИСПЛЕЙ



3"

E ЗАПУСК

START

12V

1 ВЫБОР ФУНКЦИИ

MODE



ДИСПЛЕЙ

START

2 ВЫБОР НАПРЯЖЕНИЯ

VOLT



ДИСПЛЕЙ

12V 24V



3 ПОДКЛЮЧЕНИЕ ЗАЖИМОВ К АККУМУЛЯТОРУ



ДИСПЛЕЙ

00

4 ЗАПУСК АВТОМОБИЛЯ



5 30-СЕКУНДНЫЙ ТАЙМЕР ДО СЛЕДУЮЩЕГО ЗАПУСКА

ДИСПЛЕЙ

30
29
28

6 ВЫХОД ИЗ ФУНКЦИИ

MODE



ИНФОРМАЦИЯ О СИГНАЛАХ ТРЕВОГИ



Info Alarm

AL 1

КОРОТКОЕ ЗАМЫКАНИЕ

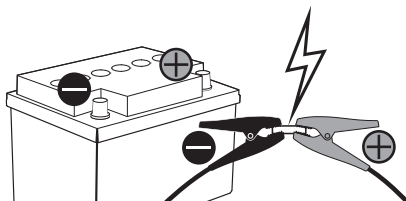

НЕСОБЛЮЖДЕНИЕ ПОЛЯРНОСТИ

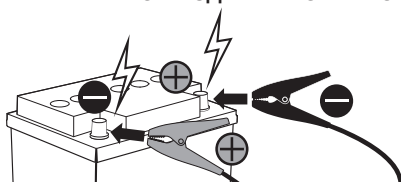

AL 2

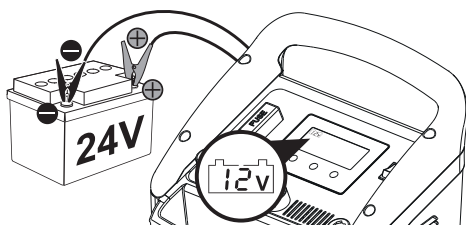

AL 4

AL 5

AL 6

AL 7

AL 8

Pulse *mm* Tronic



AL 9

КОРОТКОЕ ЗАМЫКАНИЕ

EQUALIZATION

DIAGNOSTIC

SUPPLY

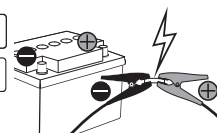

ОТОБРАЖЕНИЕ СИГНАЛОВ ПЕРЕГРЕВ Автоматическое возобновление работы

000



ТРЕВОГА ТЕРМОЗАЩИТА

00



ECRÃ LCD (pag. 2)

1. Tensão da bateria configurada.
2. Ecrã principal: tensão -corrente medida de bateria, Ah de seleção, valor de tensão selecionado para os programas Supply / Equalization, mensagens de interface na direção do operador, códigos de alarme.
3. Alarme para inversão de polaridade, curto-circuito, bateria consumida ou avariada.
4. Corrente e tensão configurada. Códigos de alarme "AL1 - AL9".
5. Nível de carga da bateria.
6. Escolha da corrente de carga PULSE-TRONIC: AUTO, BOOST, Personalizada (configuração Ah).
7. Funcionamento em baixas temperaturas.
9. Modalidade EQUALIZATION.
10. Modalidade DESULFATION.
11. Escolha da tipologia de bateria:
WET: baterias de chumbo, eletrolítica líquido;
GEL: baterias de chumbo, lacradas, eletrolítica sólido;
AGM: baterias de chumbo, lacradas, eletrolítica sobre material absorvente;
+ (CA): baterias de chumbo cálcio.
12. Modalidade SUPPLY.
14. Fases de carga PULSE-TRONIC.
15. Modalidade START.
16. Modalidade de carga automática.
17. Carga em PULSE-TRONIC.
18. Teste de funcionamento do circuito de recarga (alternador).
19. Teste de capacidade de arranque da bateria - CCA.
20. Teste estado de carga da bateria.
21. VOLT – Botão configuração:
 - tensão da bateria 12/24V;
 - regulação da voltagem/Ah.
22. FUNCTION – Botão de configuração:
 - CARGA PULSE -TRONIC (AUTO, AUTO * , WET, EFB, GEL, AGM +, Li);
 - TEST (estado bateria, alternador veículo, capacidade de arranque da bateria);
 - Programas Avançados (DESULFATION, EQUALIZATION, SUPPLY);
 - regulação da voltagem/Ah.
23. MODE – Botão configuração:
 - corrente de saída (AUTO, BOOST, personalizada);
 - Modalidade START.

FUNÇÕES

- A. CARGA PULSE TRONIC
- B. TESTE
 - TESTE ESTADO DE CARGA
 - TESTE CAPACIDADE DE ARRANQUE DA BATERIA (CCA)
 - TESTE ALTERNADOR
- C. MANUTENÇÃO DAS BATERIAS
 - EQUALIZAÇÃO
 - DESSULFATAÇÃO
- D. ALIMENTAÇÃO
 - ALIMENTAÇÃO
- E. ARRANQUE - START

INFO ALARMES

LIGAÇÃO

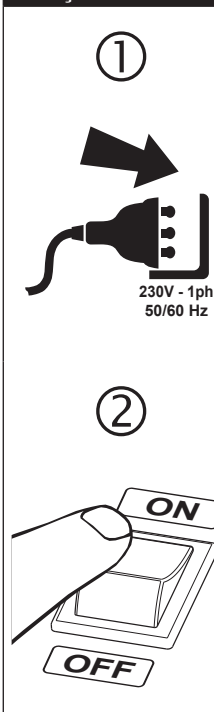

DESLIGAMENTO

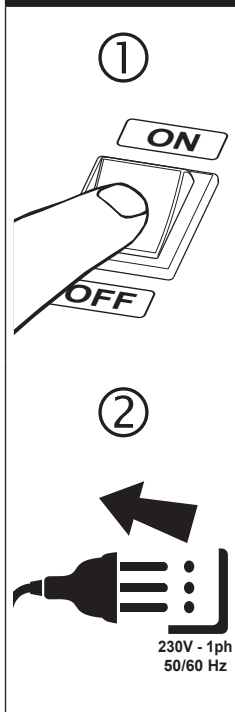

A CARGA/CONSERVAÇÃO

TECNOLOGIA PULSE-TRONIC

Pulse^{TRONIC}



1 SELEÇÃO DE TIPOLOGIA DA BATERIA

FUNCTION



5 CONEXÃO PINÇAS

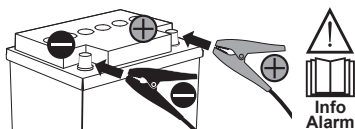

ARRANQUE DEPOIS DE 5''

2 SELEZIONE TIPOLOGIA BATTERIA

FUNCTION



6 GRÁFICO PULSE-TRONIC

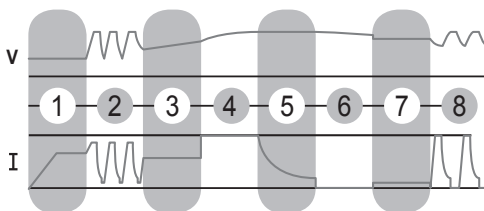

- 1 Teste da bateria
- 2 Recuperação de baterias sulfatadas/muito descarregadas
- 3 Controlo da integridade
- 4 Carga até 80%
- 5 Carga até 100%
- 6 Monitor de retenção carga
- 7 Conservação carga
- 8 Restauração carga por pulsos

3 SELEÇÃO CORRENTE

MODE

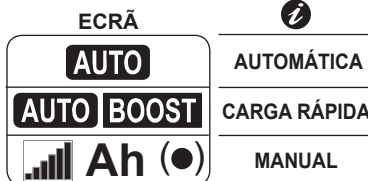

3A (●) CONFIGURAÇÃO Ah - EXEMPLO

MODE

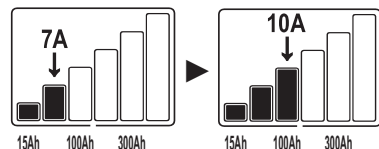

VOLT



80Ah
75Ah
70Ah

FUNCTION



100Ah
95Ah
90Ah

7 FIM DA CARGA - EXEMPLO



4 SELEÇÃO TENSÃO

VOLT

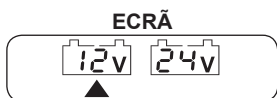

B TESTE

ESTADO DA CARGA



1 SELEÇÃO TESTE

FUNCTION



ECRÃ
TEST



2 SELEÇÃO DE TIPOLOGIA DA BATERIA

FUNCTION



ECRÃ
WET EFB GEL AGM + Li



3 CONEXÃO PINÇAS

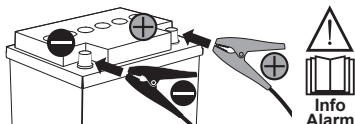

4 SELEÇÃO TENSÃO

VOLT

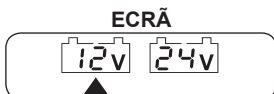

5 FIM TESTE - EXEMPLO



LEGENDA ECRÃ



B TESTE

CAPACIDADE ARRANQUE BATERIA



1 SELEÇÃO TESTE

FUNCTION



ECRÃ
TEST



2 CONEXÃO PINÇAS

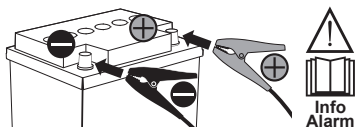

3 SELEÇÃO TENSÃO

VOLT

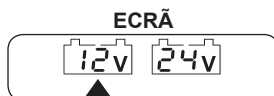

ECRÃ



4 ARRANQUE VEÍCULO



5 FIM TESTE - EXEMPLO



LEGENDA ECRÃ



B TESTE

ALTERNADOR



1 SELEÇÃO TESTE

FUNCTION



2 CONEXÃO PINÇAS

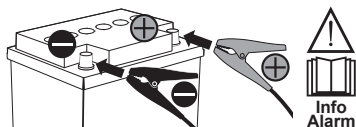

3 SELEÇÃO TENSÃO

VOLT

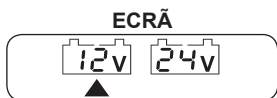

4 ARRANQUE VEÍCULO



5 FIM TESTE - EXEMPLO



LEGENDA ECRÃ

OK funciona	SUF suficiente	bAd insuficiente
-----------------------	--------------------------	----------------------------

C MANUTENÇÃO

DESSULFATAÇÃO

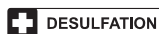

1 SELEÇÃO MENU AVANÇADO

FUNCTION



2 SELEÇÃO FUNÇÃO

FUNCTION

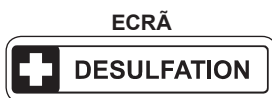

3 SELEÇÃO DE TENSÃO

VOLT

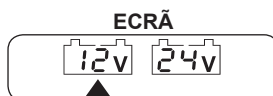

4 CONEXÃO PINÇAS

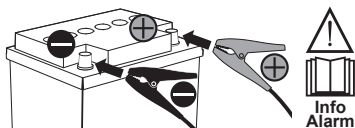

ARRANQUE DEPOIS DE 5''

5 FIM DO PROCESSO - EXEMPLO

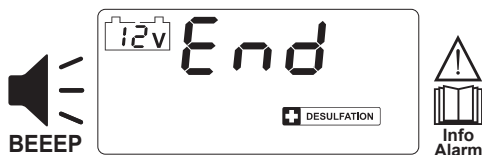

6 SAÍDA MENU AVANÇADO

FUNCTION



C MANUTENÇÃO

EQUALIZAÇÃO

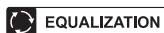

1 SELEÇÃO MENU AVANÇADO

FUNCTION



2 SELEÇÃO FUNÇÃO

FUNCTION



3 SELEÇÃO DE TENSÃO

VOLT

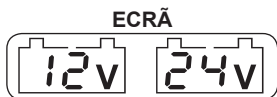

3A PERSONALIZAÇÃO TENSÃO - EXEMPLO



VERIFICAR O TIPO DE BATERIA (WET, EFB, GEL, AGM +, Li) E A MAX. TENSÃO ADMITIDA.

VOLT



FUNCTION

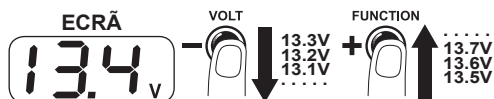

4 CONEXÃO PINÇAS

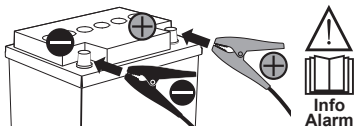

ARRANQUE DEPOIS DE 5''

5 FIM DO PROCESSO - EXEMPLO

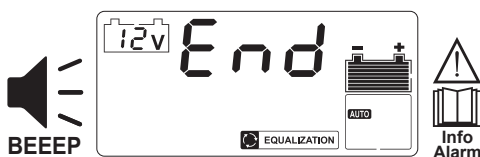

6 SAÍDA MENU AVANÇADO

FUNCTION



BLOQUEIO / DESBLOQUEIO TECLADO

BLOQUEIO

VOLT



MODE



ECRÃ

Lok on

DESBLOQUEIO

VOLT



MODE



ECRÃ

Lok off

D ALIMENTAÇÃO

ALIMENTADOR

SUPPLY

SUBSTITUIÇÃO
DA BATERIA

1 SELEÇÃO MENU AVANÇADO

FUNCTION



3"



BEEEP



2 SELEÇÃO FUNÇÃO

FUNCTION



ECRÃ



PRESENÇA DE TENSÃO ENTRE AS PINÇAS (MAX 27V).

3 SELEÇÃO DE TENSÃO

VOLT



ECRÃ



Info Alarm

3A PERSONALIZAÇÃO TENSÃO - EXEMPLO



VERIFICAR NAS ESPECIFICAÇÕES DO FABRICANTE DO VEÍCULO A MAX. TENSÃO ADMITIDA.

VOLT



3"

FUNCTION



BEEEP

ECRÃ



VOLT



FUNCTION

13.3V
13.2V
13.1V

13.7V
13.6V
13.5V

3B PERSONALIZAÇÃO CORRENTE - EXEMPLO

MODE

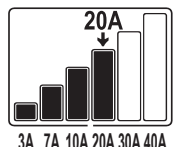
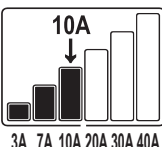

4 ECRÃ - EXEMPLO



SUPPLY

5 CONEXÃO DAS PINÇAS NOS CABOS DA BATERIA DO VEÍCULO

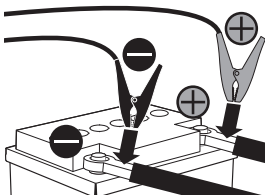

6



REMOÇÃO
DA BATERIA



SUBSTITUIÇÃO
DA BATERIA

7 SAÍDA MENU AVANÇADO

FUNCTION



3"



BEEEP

BLOQUEIO / DESBLOQUEIO TECLADO

BLOQUEIO

VOLT



MODE



ECRÃ

Lok on

DESBLOQUEIO

VOLT



MODE



ECRÃ

Lok off

E ARRANQUE

START

12v

1 SELEÇÃO FUNÇÃO

MODE



ECRÃ

START

2 SELEÇÃO TENSÃO

VOLT



ECRÃ

12v 24v



Info Alarm

3 CONEXÃO DAS PINÇAS NA BATERIA

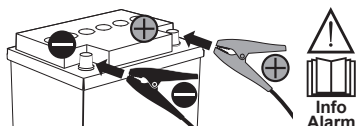

ECRÃ

Go

4 ARRANQUE VEÍCULO



5 TEMPORIZADOR 30" PARA ARRANQUE POSTERIOR

ECRÃ

30
29
28

6 SAÍDA DE FUNÇÃO

MODE



INFO ALARMES



Info Alarm

AL 1

CURTO-CIRCUITO

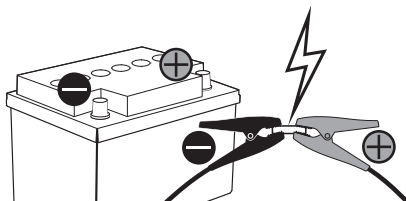

INVERSÃO POLARIDADE

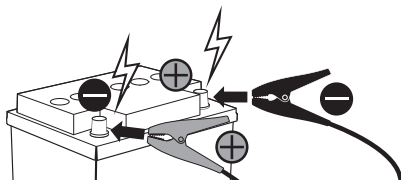

AL 2

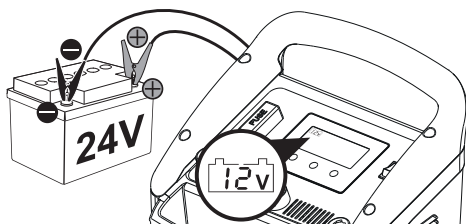

AL 4

AL 5

AL 6

AL 7

AL 8

Pulse *mm*
Tronic



AL 9

CURTO-CIRCUITO

EQUALIZATION

DIAGNOSTIC

SUPPLY

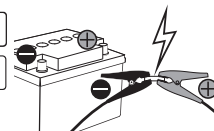

AVISO
SOBREAQUECIMENTO
Reposição automática

000



ALARME
TÉRMICO

00



ΟΘΟΝΗ LCD (σελ. 2)

1. Προσδιορισμένη τάση μπαταρίας.
2. Κύρια οθόνη: μετρημένη τάση-ρεύμα μπαταρίας, Ah επιλογής, τιμή τάσης επιλεγμένη για τα προγράμματα Supply / Equalization, μηνύματα διεπαφής προς χειριστή, κωδικοί συναγερωμών.
3. Συναγερωμός για αντιστροφή πολικότητας, βραχυκύκλωμα, μπαταρία φθαρμένη ή με βλάβη.
4. Προσδιορισμένη τάση και ρεύμα. Κωδικοί συναγερωμών "AL1 - AL9".
5. Στάθμη φορτίου μπαταρίας.
6. Επιλογή ρεύματος φόρτισης PULSE-TRONIC: AUTO, BOOST, Εξατομικευμένη (ρύθμιση Ah).
7. Λειτουργία σε χαμηλές θερμοκρασίες.
9. Τρόπος EQUALIZATION.
10. Τρόπος DESULFATION.
11. ΕΕπιλογή τύπου μπαταρίας:
WET: μπαταρίες μολύβδου, υγρός ηλεκτρολύτης,
GEL: μπαταρίες μολύβδου, σφραγισμένες, στερεός ηλεκτρολύτης,
AGM: μπαταρίες μολύβδου, σφραγισμένες, ηλεκτρολύτης σε απορροφητικό υλικό,
+ (CA): μπαταρίες μολύβδου ασβεστίου.
12. Τρόπος SUPPLY.
14. Φάσεις φόρτισης PULSE-TRONIC.
15. Τρόπος START.
16. Τρόπος αυτόματης φόρτισης.
17. Φόρτιση σε PULSE-TRONIC.
18. Τεστ λειτουργίας κυκλώματος επαναφόρτισης (εναλλακτήρας).
19. Τεστ ικανότητας εκκίνησης μπαταρίας - CCA.
20. Τεστ κατάστασης φορτίου μπαταρίας.
21. VOLT - Πλήκτρο ρύθμισης:
- τάση μπαταρίας 12/24V,
- ρύθμιση τάσης/Ah.
22. FUNCTION - Πλήκτρο ρύθμισης:
- ΦΟΡΤΙΣΗ PULSE -TRONIC (AUTO, AUTO * , WET, EFB, GEL, AGM +, Li);
- TEST (κατάσταση μπαταρίας, εναλλακτήρας οχήματος, ικανότητα εκκίνησης μπαταρίας),
- Προχωρημένα Προγράμματα (DESULFATION, EQUALIZATION, SUPPLY);
- ρύθμιση τάσης/Ah.
23. MODE - Πλήκτρο ρύθμισης:
- ρεύμα εξόδου (AUTO, BOOST, εξατομικευμένο),
- Τρόπος START.

ΛΕΙΤΟΥΡΓΙΕΣ

- A. ΦΟΡΤΙΣΗ PULSE TRONIC
- B. ΤΕΣΤ
 - ΤΕΣΤ ΚΑΤΑΣΤΑΣΗΣ ΦΟΡΤΙΟΥ
 - ΤΕΣΤ ΙΚΑΝΟΤΗΤΑΣ ΕΚΚΙΝΗΣΗΣ ΜΠΑΤΑΡΙΑΣ (CCA)
 - ΤΕΣΤ ΕΝΑΛΛΑΚΤΗΡΑ
- C. ΣΥΝΤΗΡΗΣΗΣ ΜΠΑΤΑΡΙΩΝ
 - ΙΣΟΣΤΑΘΜΙΣΗ
 - ΑΠΟΘΕΙΩΣΗ
- D. ΤΡΟΦΟΔΟΤΗΣΗ ΙΣΧΥΟΣ
 - ΤΡΟΦΟΔΟΣΙΑ
- E. ΕΚΚΙΝΗΣΗ - START

ΠΛΗΡΟΦΟΡΙΕΣ ΣΥΝΑΓΕΡΜΩΝ

ΕΝΕΡΓΟΠΟΙΗΣΗ

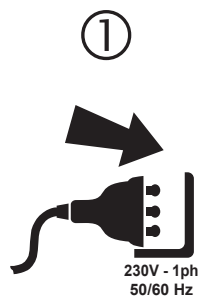

②

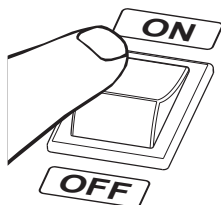

ΣΒΗΣΙΜΟ

①

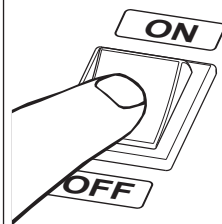

②

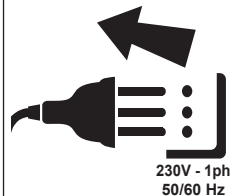

A ΦΟΡΤΙΣΗ/ΔΙΑΤΗΡΗΣΗ

ΤΕΧΝΟΛΟΓΙΑ PULSE-TRONIC

Pulse TRONIC



1 ΕΠΙΛΟΓΗ PULSE-TRONIC

FUNCTION



ΟΘΟΝΗ

Pulse TRONIC

2 ΕΠΙΛΟΓΗ ΤΥΠΟΥ ΜΠΑΤΑΡΙΑΣ

FUNCTION



ΟΘΟΝΗ



ΑΥΤΟΜΑΤΟ

ΑΥΤΟΜΑΤΟ
ΧΕΙΜΩΝΑΣ T<0°C
ΧΕΙΡΟΚΙΝΗΤΟ

3 ΕΠΙΛΟΓΗ ΡΕΥΜΑΤΟΣ

MODE



ΟΘΟΝΗ



ΑΥΤΟΜΑΤΟ

ΓΡΗΓΟΡΗ
ΦΟΡΤΙΣΗ

ΧΕΙΡΟΚΙΝΗΤΟ

3A (●) ΡΥΘΜΙΣΗ Ah - ΠΑΡΑΔΕΙΓΜΑ

MODE

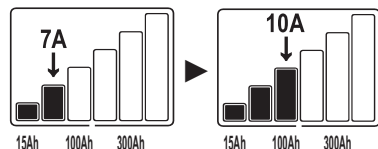

ΟΘΟΝΗ

85 Ah

VOLT



80Ah
75Ah
70Ah

FUNCTION



100Ah
95Ah
90Ah

4 ΕΠΙΛΟΓΗ ΤΑΣΗΣ

VOLT



ΟΘΟΝΗ



5 ΣΥΝΔΕΣΗ ΛΑΒΙΔΩΝ

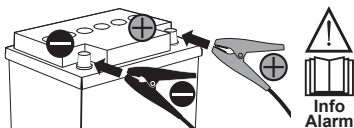

Info Alarm

ΕΚΚΙΝΗΣΗ ΜΕΤΑ 5"

6 ΔΙΑΓΡΑΜΜΑ PULSE-TRONIC

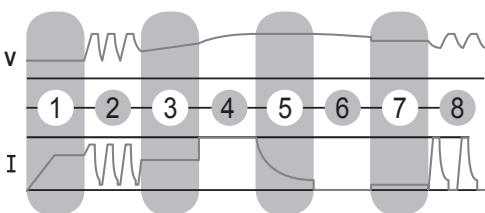

- 1 Τεστ μπαταρίας
- 2 Ανάκτηση σουλφονικών/πολύ εκφορτισμένων μπαταριών
- 3 Έλεγχος ακεραιότητας
- 4 Φόρτιση μέχρι 80%
- 5 Φόρτιση μέχρι 100%
- 6 Παρακολούθηση συγκράτησης φορτίου
- 7 Διατήρηση φορτίου
- 8 Αποκατάσταση φορτίου με παλμούς

7 ΤΕΛΟΣ ΦΟΡΤΙΣΗΣ - ΠΑΡΑΔΕΙΓΜΑ



B ΤΕΣΤ

ΚΑΤΑΣΤΑΣΗ ΦΟΡΤΙΟΥ



1 ΕΠΙΛΟΓΗ ΤΕΣΤ

FUNCTION



ΟΘΟΝΗ
TEST



2 ΕΠΙΛΟΓΗ ΤΥΠΟΥ ΜΠΑΤΑΡΙΑΣ

FUNCTION



ΟΘΟΝΗ
WET EFB GEL AGM + Li



3 ΣΥΝΔΕΣΗ ΛΑΒΙΔΩΝ

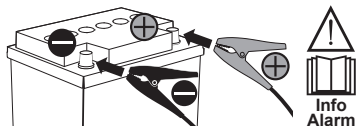

4 ΕΠΙΛΟΓΗ ΤΑΣΗΣ

VOLT



ΟΘΟΝΗ
12V 24V



5 ΤΕΛΟΣ ΤΕΣΤ - ΠΑΡΑΔΕΙΓΜΑ



ΛΕΖΑΝΤΑ ΟΘΟΝΗΣ



B ΤΕΣΤ

ΙΚΑΝΟΤΗΤΑ ΕΚΚΙΝΗΣΗΣ ΜΠΑΤΑΡΙΑΣ



1 ΕΠΙΛΟΓΗ ΤΕΣΤ

FUNCTION



ΟΘΟΝΗ
TEST



2 ΣΥΝΔΕΣΗ ΛΑΒΙΔΩΝ

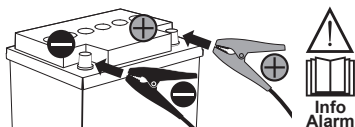

3 ΕΠΙΛΟΓΗ ΤΑΣΗΣ

VOLT



ΟΘΟΝΗ
12V 24V



ΟΘΟΝΗ

60

4 ΕΚΚΙΝΗΣΗ ΟΧΗΜΑΤΟΣ



5 ΤΕΛΟΣ ΤΕΣΤ - ΠΑΡΑΔΕΙΓΜΑ



ΛΕΖΑΝΤΑ ΟΘΟΝΗΣ



B ΤΕΣΤ

ΕΝΑΛΛΑΚΤΗΡΑΣ



1 ΕΠΙΛΟΓΗ ΤΕΣΤ

FUNCTION

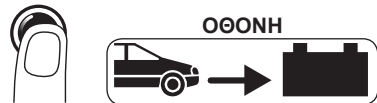

2 ΣΥΝΔΕΣΗ ΛΑΒΙΔΩΝ

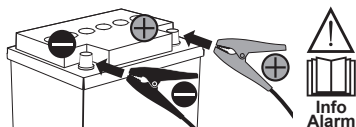

3 ΕΠΙΛΟΓΗ ΤΑΣΗΣ

VOLT

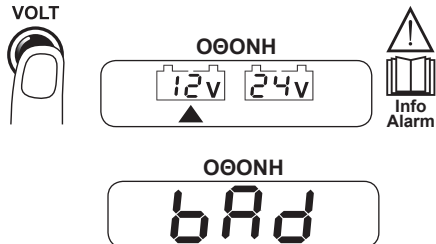

4 ΕΚΚΙΝΗΣΗ ΟΧΗΜΑΤΟΣ



5 ΤΕΛΟΣ ΤΕΣΤ - ΠΑΡΑΔΕΙΓΜΑ



ΛΕΖΑΝΤΑ ΟΘΟΝΗΣ

OK	SUF	bAd
λειτουργεί	επαρκές	ανεπαρκές

C ΣΥΝΤΗΡΗΣΗ

ΑΠΟΘΕΙΩΣΗ

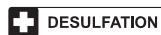

1 ΕΠΙΛΟΓΗ ΠΡΟΧΩΡΗΜΕΝΟΥ ΜΕΝΟΥ

FUNCTION



2 ΕΠΙΛΟΓΗ ΛΕΙΤΟΥΡΓΙΑΣ

FUNCTION



3 ΕΠΙΛΟΓΗ ΤΑΣΗΣ

VOLT

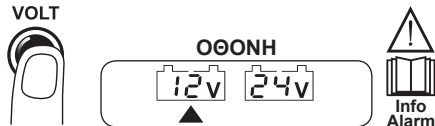

4 ΣΥΝΔΕΣΗ ΛΑΒΙΔΩΝ

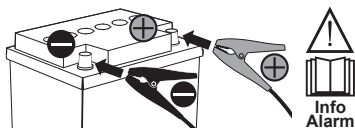

ΕΝΑΡΞΗ ΜΕΤΑ 5''

5 ΤΕΛΟΣ ΔΙΑΔΙΚΑΣΙΑΣ - ΠΑΡΑΔΕΙΓΜΑ

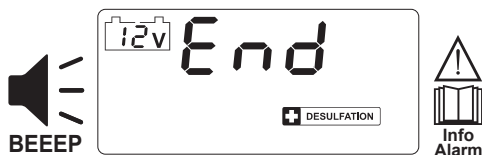

6 ΕΞΟΔΟΣ ΑΠΟ ΠΡΟΧΩΡΗΜΕΝΟ ΜΕΝΟΥ

FUNCTION



C ΣΥΝΤΗΡΗΣΗ

ΙΣΟΣΤΑΘΜΙΣΗ

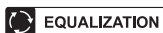

1 ΕΠΙΛΟΓΗ ΠΡΟΧΩΡΗΜΕΝΟΥ ΜΕΝΟΥ

FUNCTION

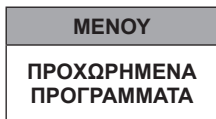

4 ΣΥΝΔΕΣΗ ΛΑΒΙΔΩΝ

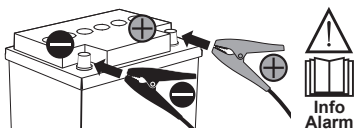

ΕΝΑΡΞΗ ΜΕΤΑ 5"

2 ΕΠΙΛΟΓΗ ΛΕΙΤΟΥΡΓΙΑΣ

FUNCTION

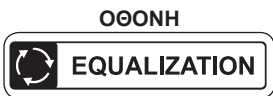

5 ΤΕΛΟΣ ΔΙΑΔΙΚΑΣΙΑΣ - ΠΑΡΑΔΕΙΓΜΑ

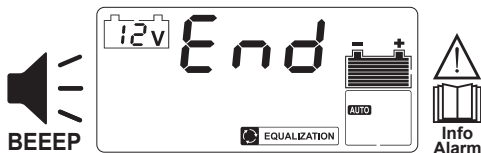

3 ΕΠΙΛΟΓΗ ΤΑΣΗΣ

VOLT

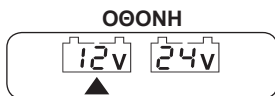

6 ΕΞΟΔΟΣ ΑΠΟ ΠΡΟΧΩΡΗΜΕΝΟ ΜΕΝΟΥ

FUNCTION



3A ΕΞΑΤΟΜΙΚΕΥΣΗ ΤΑΣΗΣ - ΠΑΡΑΔΕΙΓΜΑ



ΕΠΑΛΗΘΕΥΣΤΕ ΤΟΝ ΤΥΠΟ ΜΠΑΤΑΡΙΑΣ (WET, EFB, GEL, AGM +, Li) ΚΑΙ ΤΗ ΜΕΓΙΣΤΗ ΑΠΟΔΕΚΤΗ ΤΑΣΗ.

VOLT



FUNCTION

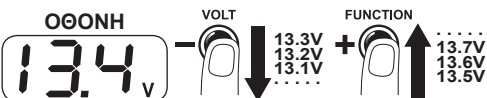

ΦΡΑΓΗ / ΑΠΟΦΡΑΓΗ ΠΛΗΚΤΡΟΛΟΓΙΟΥ

ΦΡΑΓΗ

VOLT



MODE



ΟΘΟΝΗ

Lok on

ΑΠΟΦΡΑΓΗ

VOLT



MODE



ΟΘΟΝΗ

Lok off

D ΤΡΟΦΟΔΟΣΙΑ

ΤΡΟΦΟΔΟΤΗΣ

SUPPLY

ΑΛΛΑΓΗ ΜΠΑΤΑΡΙΑΣ

1 ΕΠΙΛΟΓΗ ΠΡΟΧΩΡΗΜΕΝΟΥ ΜΕΝΟΥ

FUNCTION



3"



ΒΕΕΕΡ

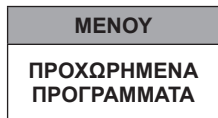

2 ΕΠΙΛΟΓΗ ΛΕΙΤΟΥΡΓΙΑΣ

FUNCTION



ΟΘΟΝΗ

SUPPLY



ΠΑΡΟΥΣΙΑ ΤΑΣΗΣ ΑΝΑΜΕΣΑ ΣΤΙΣ ΛΑΒΙΔΕΣ (MAX 27V).

3 ΕΠΙΛΟΓΗ ΤΑΣΗΣ

VOLT



ΟΘΟΝΗ



Info Alarm

3A ΕΞΑΤΟΜΙΚΕΥΣΗ ΤΑΣΗΣ - ΠΑΡΑΔΕΙΓΜΑ



ΕΠΑΛΗΘΕΥΣΤΕ ΑΠΟ ΤΙΣ ΟΔΗΓΙΕΣ ΤΟΥ ΚΑΤΑΣΚΕΥΑΣΤΗ ΟΧΗΜΑΤΟΣ ΤΗ ΜΕΓΙΣΤΗ ΑΠΟΔΕΚΤΗ ΤΑΣΗ.

VOLT



3"

FUNCTION



ΒΕΕΕΡ

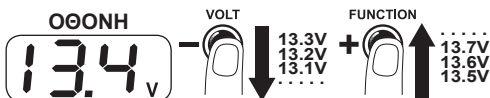

3B ΕΞΑΤΟΜΙΚΕΥΣΗ ΡΕΥΜΑΤΟΣ - ΠΑΡΑΔΕΙΓΜΑ

MODE

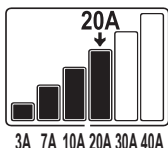
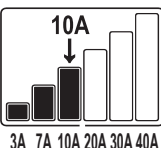

4 ΟΘΟΝΗ - ΠΑΡΑΔΕΙΓΜΑ



SUPPLY

5 ΣΥΝΔΕΣΗ ΛΑΒΙΔΩΝ ΣΕ ΚΑΛΩΔΙΑ ΜΠΑΤΑΡΙΑΣ ΟΧΗΜΑΤΟΣ

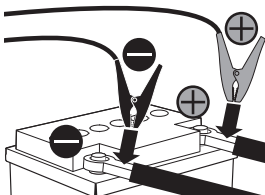

6



ΑΦΑΙΡΕΣΗ ΜΠΑΤΑΡΙΑΣ



ΑΝΤΙΚΑΤΑΣΤΑΣΗ ΜΠΑΤΑΡΙΑΣ

7 ΕΞΟΔΟΣ ΑΠΟ ΠΡΟΧΩΡΗΜΕΝΟ ΜΕΝΟΥ

FUNCTION



3"



ΒΕΕΕΡ

ΦΡΑΓΗ / ΑΠΟΦΡΑΓΗ ΠΛΗΚΤΡΟΛΟΓΙΟΥ

ΦΡΑΓΗ

VOLT



MODE



3"

ΟΘΟΝΗ

Lok on

ΑΠΟΦΡΑΓΗ

VOLT



MODE



3"

ΟΘΟΝΗ

Lok off

E ΕΚΚΙΝΗΣΗ

START

12V

1 ΕΠΙΛΟΓΗ ΛΕΙΤΟΥΡΓΙΑΣ

MODE



ΟΘΟΝΗ

START

2 ΕΠΙΛΟΓΗ ΤΑΣΗΣ

VOLT



ΟΘΟΝΗ

12V 24V



3 ΣΥΝΔΕΣΗ ΛΑΒΙΔΩΝ ΣΤΗΝ ΜΠΑΤΑΡΙΑ

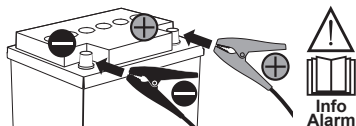

ΟΘΟΝΗ

Go

4 ΕΚΚΙΝΗΣΗ ΟΧΗΜΑΤΟΣ



5 ΧΡΟΝΟΔΙΑΚΟΠΤΗΣ 30" ΓΙΑ ΚΑΘΥΣΤΕΡΗΜΕΝΗ ΕΚΚΙΝΗΣΗ

ΟΘΟΝΗ

30
29
28

6 ΕΞΟΔΟΣ ΑΠΟ ΛΕΙΤΟΥΡΓΙΑ

MODE



ΠΛΗΡΟΦΟΡΙΕΣ ΣΥΝΑΓΕΡΜΩΝ



Info Alarm

RL 1

ΒΡΑΧΥΚΥΚΛΩΜΑ

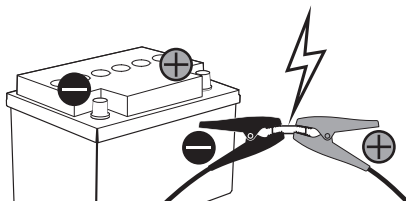

ΑΝΤΙΣΤΡΟΦΗ ΠΟΛΙΚΟΤΗΤΑΣ

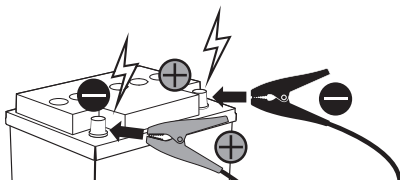

RL 2

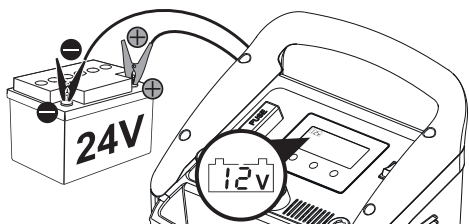

RL 4

RL 5

RL 6

RL 7

RL 8

Pulse Tronic



RL 9

ΒΡΑΧΥΚΥΚΛΩΜΑ

EQUALIZATION

DIAGNOSTIC

SUPPLY

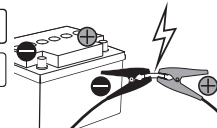

ΣΗΜΑΝΣΗ ΥΠΕΡΘΕΡΜΑΝΣΗ
Αυτόματη αποκατάσταση

000



ΣΥΝΑΓΕΡΜΟΣ ΘΕΡΜΙΚΟΣ

00



LCD-DISPLAY (pag. 2)

1. Ingestelde accu spanning.
2. Hoofddisplay: gemeten accu spanningstroom, geselecteerde Ah, geselecteerde spanningswaarde voor de programma's Supply / Equalization, berichten voor de bediener, alarmcodes.
3. Alarm voor omgekeerde polariteit, kortsluiting, versleten of defecte accu.
4. Ingestelde stroom en spanning. Alarmcodes "AL1 - AL9".
5. Opladingsniveau van de accu.
6. Keuze laadstroom PULSE-TRONIC: AUTO, BOOST, persoonlijke instelling (instelling Ah).
7. Werking bij lage temperaturen.
9. Modus EQUALIZATION.
10. Modus DESULFATION.
11. Type accu kiezen:
WET: loodaccu's, vloeibare elektrolyt;
GEL: loodaccu's, verzegeld, vaste elektrolyt;
AGM: loodaccu's, verzegeld, elektrolyt op absorberend materiaal;
+ (CA): lood-calciumaccu's.
12. Modus SUPPLY.
14. Laadfasen PULSE-TRONIC.
15. Modus START.
16. Automatische laadmodus.
17. Laden in PULSE-TRONIC.
18. Test werking van het laadsysteem (alternator).
19. Test koudstartstroom van de accu - CCA.
20. Test opladingsniveau accu.
21. VOLT - Instellingstoets:
- accu spanning 12/24V;
- regeling spanning/Ah.
22. FUNCTION - Instellingstoets:
- LADEN PULSE -TRONIC (AUTO, AUTO ✱, WET, EFB, GEL, AGM +, Li);
- TEST (status accu, alternator voertuig, koudstartstroom accu);
- Geavanceerde programma's (DESULFATION, EQUALIZATION, SUPPLY);
- regeling spanning/Ah.
23. MODE - Instellingstoets:
- uitgangsstroom (AUTO, BOOST, persoonlijke instelling);
- Modus START.

FUNCTIES

- A. PULSE TRONIC LADEN
- B. TEST
- TEST OPLADINGSNIVEAU
- TEST KOUDSTARTSTROOM VAN DE ACCU (CCA)
- TEST ALTERNATOR
- C. ONDERHOUD ACCU'S
- GELIJKRICHTEN
- DESULFATEREN
- D. VOORZIENING
- VOEDING
- E. STARTEN - START

INFO ALARMEN

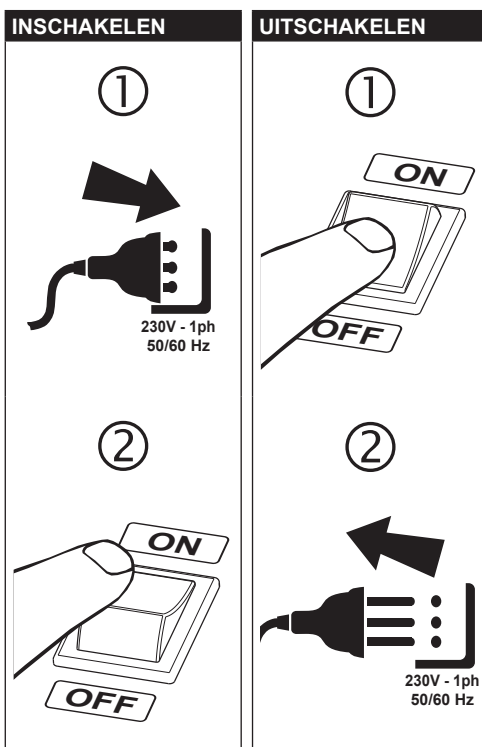

A LADING/BEHOUD

PULSE-TRONIC TECHNOLOGIE

Pulse^{TRONIC}



1 PULSE-TRONIC SELECTEREN

FUNCTION



2 TYPE ACCU SELECTEREN

FUNCTION



i
AUTOMATISCH
AUTOMATISCH WINTER T<0°C
HANDMATIG

3 STROOM SELECTEREN

MODE

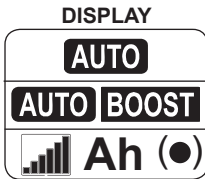

i
AUTOMATISCH
SNEL LADEN
HANDMATIG

3A (●) INSTELLING Ah - VOORBEELD

MODE

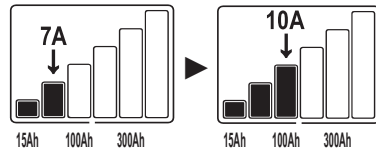

VOLT



80Ah
75Ah
70Ah

FUNCTION



100Ah
95Ah
90Ah

4 SPANNING SELECTEREN

VOLT

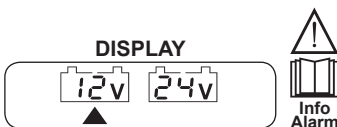

5 KLEMMEN AANSLUITEN

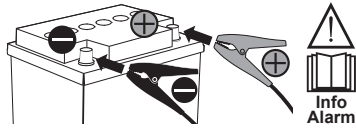

START NA 5 SEC.

6 GRAFIEK PULSE-TRONIC

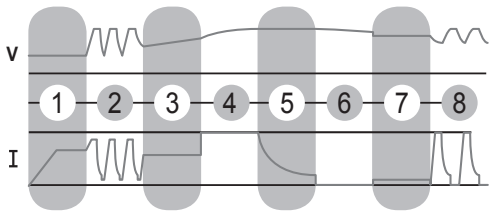

- 1 Test van de accu
- 2 Herstel gesulfateerde/bijna lege accu's
- 3 Controle van de integriteit
- 4 Lading tot 80%
- 5 Lading tot 100%
- 6 Bewaking behoud van de lading
- 7 Behoud lading
- 8 Herstel lading met pulsen

7 EINDE LADING - VOORBEELD



B TEST

OPLADINGSNIVEAU

1 TEST SELECTEREN

FUNCTION



DISPLAY
TEST 



2 TYPE ACCU SELECTEREN

FUNCTION



DISPLAY
WET EFB GEL AGM + Li
▲



3 KLEMMEN AANSLUITEN

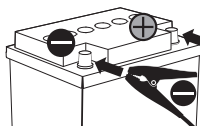

4 SPANNING SELECTEREN

VOLT

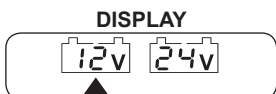

5 EINDE TEST - VOORBEELD



LEGENDA DISPLAY



B TEST

KOUDSTARTSTROOM VAN DE ACCU

1 TEST SELECTEREN

FUNCTION



DISPLAY
TEST  



2 KLEMMEN AANSLUITEN

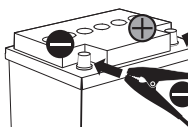

3 SPANNING SELECTEREN

VOLT

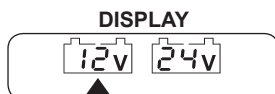

4 VOERTUIG STARTEN



5 EINDE TEST - VOORBEELD



LEGENDA DISPLAY



B TEST

ALTERNATOR



1 TEST SELECTEREN

FUNCTION



DISPLAY



2 KLEMMEN AANSLUITEN

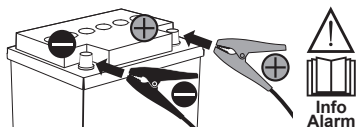

3 SPANNING SELECTEREN

VOLT



DISPLAY

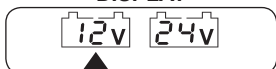

DISPLAY



4 VOERTUIG STARTEN



5 EINDE TEST - VOORBEELD



LEGENDA DISPLAY

OK	SUF	bAd
werkt goed	voldoende	onvoldoende

C ONDERHOUD

DESULFATEREN

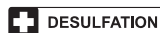

1 GEAVANCEERD MENU SELECTEREN

FUNCTION



MENU

GEAVANCEERDE
PROGRAMMA'S

2 FUNCTIE SELECTEREN

FUNCTION



DISPLAY

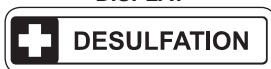

3 SPANNING SELECTEREN

VOLT



DISPLAY



4 KLEMMEN AANSLUITEN

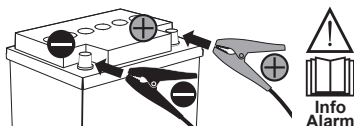

START NA 5 SEC.

5 EINDE PROCES - VOORBEELD



6 GEAVANCEERD MENU AFSLUITEN

FUNCTION



C ONDERHOUD

GELIJKRICHTEN

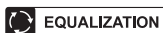

1 GEAVANCEERD MENU SELECTEREN

FUNCTION

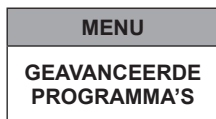

4 KLEMMEN AANSLUITEN

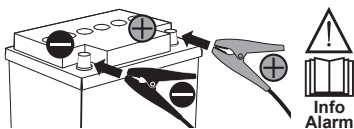

START NA 5 SEC.

2 FUNCTIE SELECTEREN

FUNCTION



DISPLAY



5 EINDE PROCES - VOORBEELD

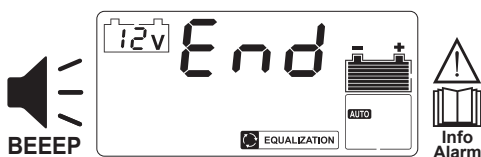

3 SPANNING SELECTEREN

VOLT



DISPLAY

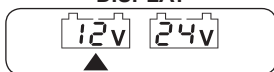

6 GEAVANCEERD MENU AFSLUITEN

FUNCTION



3A SPANNING AANPASSEN - VOORBEELD



HET TYPE ACCU (WET, EFB, GEL, AGM +, Li) EN DE MAX. TOEGELATEN SPANNING CONTROLEREN.

VOLT



FUNCTION



TOETSENBORD BLOKKEREN/DEBLOKKEREN

BLOKKEREN

VOLT



MODE



DISPLAY



DEBLOKKEREN

VOLT



MODE



DISPLAY

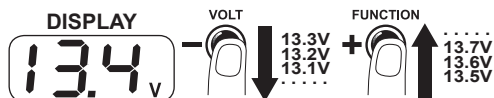

D VOEDING

LADER

SUPPLY

ACCU
VERVANGEN

1 GEAVANCEERD MENU SELECTEREN

FUNCTION

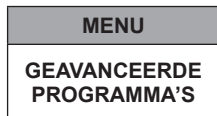

2 FUNCTIE SELECTEREN

FUNCTION



DISPLAY



SPANNING AANWEZIG TUSSEN DE
KLEMMEN (MAX 27V).

3 SPANNING SELECTEREN

VOLT



DISPLAY



3A SPANNING AANPASSEN - VOORBEELD



IN DESPECIFICATIESVAN DECONSTRUCTEUR
VAN HET VOERTUIG DE MAX. TOEGELATEN
SPANNING CONTROLEREN.

VOLT



FUNCTION



DISPLAY



VOLT



13.3V
13.2V
13.1V
.....

FUNCTION



13.7V
13.6V
13.5V
.....

3B STROOM AANPASSEN - VOORBEELD

MODE

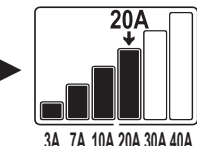
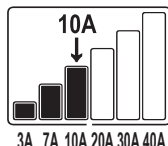

4 DISPLAY - VOORBEELD



SUPPLY

5 KLEMMEN AANSLUITEN OP ACCUKABELS VOERTUIG

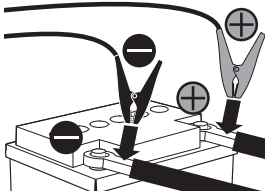

6



ACCU
VERWIJDEREN



ACCU
VERVANGEN

7 GEAVANCEERD MENU AFSLUITEN

FUNCTION



TOETSENBOORD BLOKKEREN/DEBLOKKEREN

BLOKKEREN

VOLT



MODE



DISPLAY

Lok on

DEBLOKKEREN

VOLT



MODE



DISPLAY

Lok off

E STARTHULP

STARTEN

12V

1 FUNCTIE SELECTEREN

MODE



DISPLAY

START

2 SPANNING SELECTEREN

VOLT



DISPLAY

12V 24V



Info Alarm

3 KLEMMEN AANSLUITEN OP DE ACCU

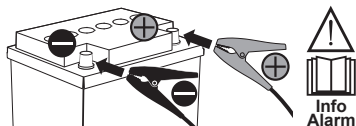

Info Alarm

DISPLAY

Go

4 VOERTUIG STARTEN



5 TIMER 30 SEC- VOOR VOLGENDE START

DISPLAY

30
29
28

6 FUNCTIE AFSLUITEN

MODE



INFO ALARMEN



Info Alarm

AL 1

KORTSLUITING

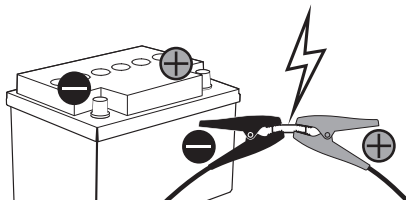

OMKERING VAN DE POLARITEIT

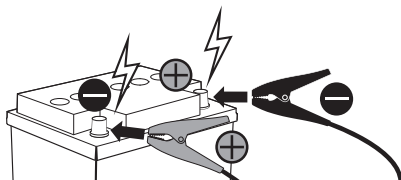

AL 2

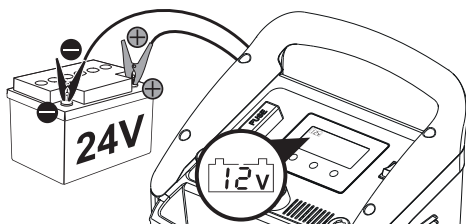

AL 4

AL 5

AL 6

AL 7

AL 8

Pulse Tronic



AL 9

KORTSLUITING

EQUALIZATION

DIAGNOSTIC

SUPPLY

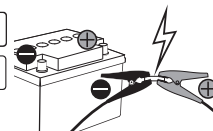

SIGNALERING
OVERVERHITTING
Automatische reset

000



THERMISCH
ALARM

0C



LCD KIJELZŐ (2. old.)

1. Beállított akkumulátor-feszültség.
2. Fő kijelző: mért akkumulátor feszültség-áram, kiválasztott Ah, a Supply / Equalization programokhoz kiválasztott feszültségérték, interfész üzenetek a kezelő felé, riasztási kódok.
3. Polaritás felcserélés, rövidzárlat, elhasználódott vagy meghibásodott akkumulátor miatti riasztás.
4. Beállított áram és feszültség.
Riasztási kódok "AL1 - AL9".
5. Az akkumulátor töltöttségi szintje.
6. PULSE-TRONIC:kiválasztása: AUTO, BOOST, Személyreszabott (beállítása Ah).
7. Alacsony hőmérsékleteken történő működés.
9. EQUALIZATION üzemmód.
10. DESULFATION üzemmód.
11. Akkumulátor típus választéka:
WET: folyékony elektrolitos ólomakkumulátorok;
GEL: szilárd elektrolitos, hermetikusan zárt ólomakkumulátorok;
AGM: abszorbens anyagú elektrolitos, hermetikusan zárt ólomakkumulátorok;
+ (CA): kalciumos ólomakkumulátorok.
12. SUPPLY üzemmód.
14. Töltési fázisok PULSE-TRONIC.
15. START üzemmód.
16. Automatikus töltési üzemmód.
17. Töltés PULSE-TRONIC-ban.
18. Feltöltő áramkör működési teszt (generátor).
19. Akkumulátor indítóképességi teszt - CCA.
20. Akkumulátor töltöttség állapotmérő teszt
21. VOLT - Beállítási gomb:
 - akkumulátor feszültség 12/24V;
 - feszültség szabályozása/Ah.
22. FUNKCIÓ - Beállítási gomb:
 - PULSE -TRONIC TÖLTÉS (AUTO, AUTO ✱, WET, EFB, GEL, AGM +, Li);
 - TESZT (akkumulátor állapota, jármű generátor, akkumulátor indítóképessége);
 - Haladó Programok (DESULFATION, EQUALIZATION, SUPPLY);
 - feszültség szabályozása/Ah.
23. MÓD - Beállítási gomb:
 - kimeneti áram (AUTO, BOOST, személyreszabott);
 - START üzemmód.

FUNKCIÓK

- A. PULSE TRONIC TÖLTÉS
- B. TESZT
 - TÖLTÉSI ÁLLAPOT TESZT
 - AKKUMULÁTOR INDÍTÓKÉPESSÉGI TESZT (CCA)
 - GENERÁTOR TESZT
- C. AKKUMULÁTOROK KARBANTARTÁSA
 - KIEGYENLÍTÉS
 - SZULFÁTLANÍTÁS
- D. ENERGIAELLÁTÁS
 - TÁPELLÁTÁS
- E. BEINDÍTÁS - START

RIASZTÁS INFÓ

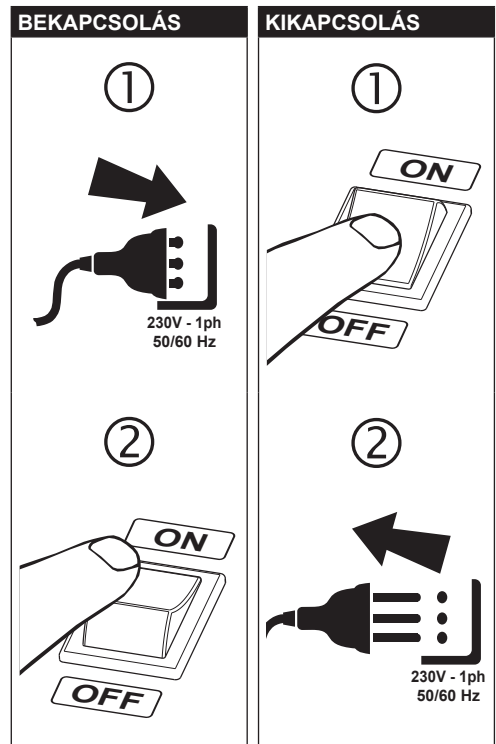

A TÖLTÉS/MEGTARTÁS

PULSE-TRONIC TECHNOLOGIA

Pulse nnn
Tronic



1 PULSE-TRONIC KIVÁLASZTÁSA

FUNCTION



KIJELZŐ

Pulse nnn
Tronic

2 AKKUMULÁTOR TÍPUS KIVÁLASZTÁSA

FUNCTION



KIJELZŐ

AUTO

AUTO ❄️

WET EFB GEL AGM + Li



AUTOMATIKA

AUTOMATIKA
TÉL H<0°C

KÉZI

3 ÁRAM KIVÁLASZTÁSA

MODE



KIJELZŐ

AUTO

AUTO BOOST

Ah (●)



AUTOMATIKA

GYORSTÖLTÉS

KÉZI

3A (●) Ah BEÁLLÍTÁSA - PÉLDA

MODE

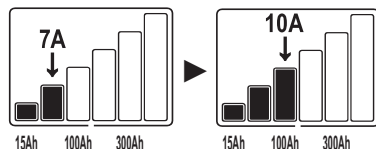

KIJELZŐ

85 Ah

VOLT



80Ah
75Ah
70Ah

FUNCTION



100Ah
95Ah
90Ah

4 FESZÜLTÉG KIVÁLASZTÁSA

VOLT



KIJELZŐ

12v 24v



5 CSIPESZEK CSATLAKOZTATÁSA

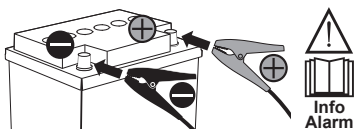

INDÍTÁS 5" UTÁN

6 PULSE-TRONIC GRAFIKON

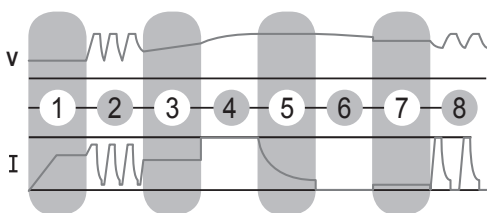

- 1 Akkumulátor teszt
- 2 Elszulfátosodott/nagyon lemerült akkumulátorok helyrehozatala
- 3 Épség ellenőrzése
- 4 Feltöltés 80%-ig
- 5 Feltöltés 100%-ig
- 6 Töltés megtartás monitor
- 7 Töltés megtartása
- 8 Impulzustöltés visszaállítása

7 TÖLTÉS VÉGE - PÉLDA



B TESZT

TÖLTÖTTSGI ÁLLAPOT



1 TESZT KIVÁLASZTÁSA

FUNCTION



KIJELZŐ
TEST



2 AKKUMULÁTOR TÍPUS KIVÁLASZTÁSA

FUNCTION



KIJELZŐ
WET EFB GEL AGM + Li



3 CSIPESZEK CSATLAKOZTATÁSA

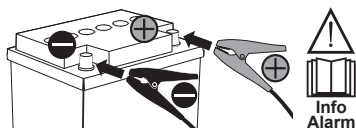

4 FESZÜLTÉG KIVÁLASZTÁSA

VOLT



KIJELZŐ

12V 24V



5 TESZT VÉGE - PÉLDA



KIJELZŐ JELMAGYARÁZAT



B TESZT

AKKUMULÁTOR INDÍTÓKÉPESSÉG



1 TESZT KIVÁLASZTÁSA

FUNCTION



KIJELZŐ
TEST



2 CSIPESZEK CSATLAKOZTATÁSA

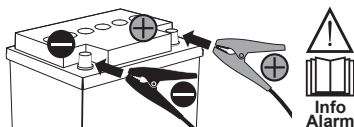

3 FESZÜLTÉG KIVÁLASZTÁSA

VOLT



KIJELZŐ

12V 24V



KIJELZŐ

00

4 JÁRMŰ BEINDÍTÁSA



5 TESZT VÉGE - PÉLDA



KIJELZŐ JELMAGYARÁZAT



B TESZT

GENERÁTOR



1 TESZT KIVÁLASZTÁSA

FUNCTION



KIJELZŐ



2 CSIPESZEK CSATLAKOZTATÁSA

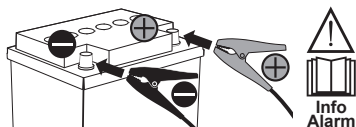

3 FESZÜLTÉG KIVÁLASZTÁSA

VOLT



KIJELZŐ

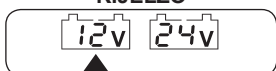

KIJELZŐ



4 JÁRMŰ BEINDÍTÁSA



5 TESZT VÉGE - PÉLDA



KIJELZŐ JELMAGYARÁZAT

OK

működő

SUF

kielégítő

bAd

elégtelen

C KARBANTARTÁS

SZULFÁTLANÍTÁS

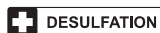

1 HALADÓ MENÜ KIVÁLASZTÁSA

FUNCTION



3"

BEEEP

MENÜ

HALADÓ
PROGRAMOK

2 FUNKCIÓ KIVÁLASZTÁSA

FUNCTION



KIJELZŐ

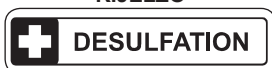

3 FESZÜLTÉG KIVÁLASZTÁSA

VOLT



KIJELZŐ



4 CSIPESZEK CSATLAKOZTATÁSA

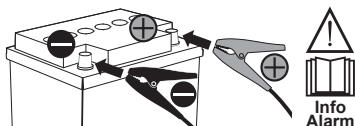

INDÍTÁS 5" UTÁN

5 FOLYAMAT VÉGE - PÉLDA

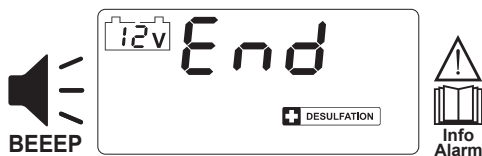

BEEEP



6 KILÉPÉS A HALADÓ MENÜBŐL

FUNCTION



3"

BEEEP

C KARBANTARTÁS

KIEGYENLÍTÉS

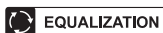

1 HALADÓ MENÜ KIVÁLASZTÁSA

FUNCTION



2 FUNKCIÓ KIVÁLASZTÁSA

FUNCTION



3 FESZÜLTÉG KIVÁLASZTÁSA

VOLT



3A FESZÜLTÉG SZEMÉLYRESZABÁS - PÉLDA



VIZSGÁLJA MEG AZ AKKUMULÁTOR TÍPUSÁT (WET, EFB, GEL, AGM +, Li) ÉS A MAX. ENGEDÉLYEZETT FESZÜLTÉSEGET.

VOLT



FUNCTION

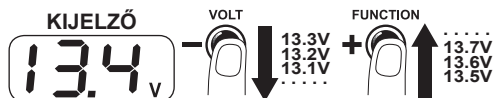

4 CSIPESZEK CSATLAKOZTATÁSA

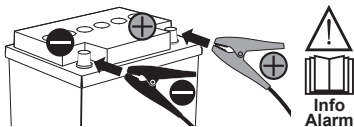

INDÍTÁS 5" UTÁN

5 FOLYAMAT VÉGE - PÉLDA

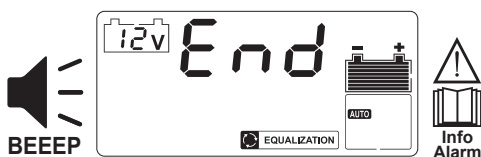

6 KILÉPÉS A HALADÓ MENÜBŐL

FUNCTION



BILLENTYŰZET BLOKKOLÁSA / KIOLDÁSA

BLOKKOLÁS

VOLT



MODE



KIJELZŐ

Lok on

KIOLDÁS

VOLT



MODE



KIJELZŐ

Lok off

D TÁPELLÁTÁS

TÁPEGYSÉG

SUPPLY

AKKUMULÁTORCSERE

1 HALADÓ MENÜ KIVÁLASZTÁSA

FUNCTION



2 FUNKCIÓ KIVÁLASZTÁSA

FUNCTION



KIJELZŐ

SUPPLY



FESZÜLTÉG JELENLÉTE A CSIPESZEK KÖZÖTT (MAX 27V).

3 FESZÜLTÉG KIVÁLASZTÁSA

VOLT



KIJELZŐ

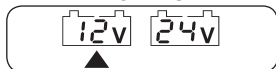

3A FESZÜLTÉG SZEMÉLYRESZABÁS - PÉLDA



VIZSGÁLJA MEG A JÁRMŰ GYÁRTÓJÁNAK SPECIFIKÁCIÓJÁBAN A MAX. ENGEDÉLYEZETT FESZÜLTSEGET.

VOLT



FUNCTION



3"

DISPLAY



13.3V
13.2V
13.1V

FUNCTION



13.7V
13.6V
13.5V

3B ÁRAM SZEMÉLYRESZABÁS - PÉLDA

MODE

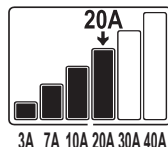
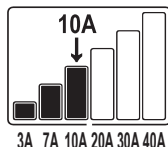

4 KIJELZŐ - PÉLDA



5 CSIPESZEK CSATLAKOZTATÁSA A JÁRMŰ AKKUMULÁTORÁNAK KÁBELEIHEZ

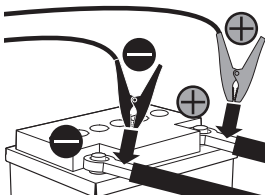

6



AKKUMULÁTOR ELTÁVOLÍTÁSA



AKKUMULÁTORCSERE

7 KILÉPÉS A HALADÓ MENÜBŐL

FUNCTION



3"

BILLENTYŰZET BLOKKOLÁSA / KIOLDÁSA

BLOKKOLÁS

VOLT



MODE



KIJELZŐ

Lok on

KIOLDÁS

VOLT



MODE



KIJELZŐ

Lok off

E BEINDÍTÁS

START

12V

1 FUNKCIÓ KIVÁLASZTÁSA

MODE



KIJELZŐ

START

2 FESZÜLTÉG KIVÁLASZTÁSA

VOLT



KIJELZŐ

12V 24V



Info Alarm

3 CSIPESZEK CSATLAKOZTATÁSA AZ AKKUMULÁTORHOZ

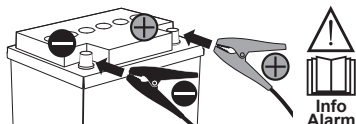

Info Alarm

KIJELZŐ

00

4 JÁRMŰ BEINDÍTÁSA



5 IDŐKAPCSOLÓ 30" KÉSŐBBI BEINDÍTÁSHOZ

KIJELZŐ

30
29
28

6 KILÉPÉS A FUNKCIÓBÓL

MODE



RIASZTÁS INFÓ



Info Alarm

AL 1

RÖVIDZÁRLAT

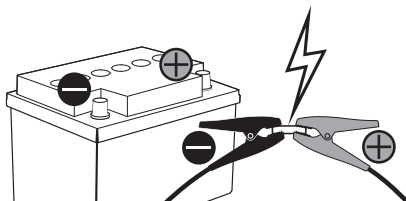

POLARITÁS FELCSERÉLÉSE

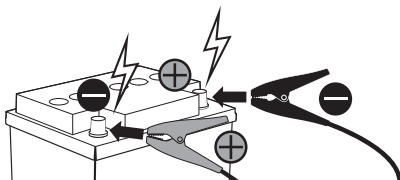

AL 2

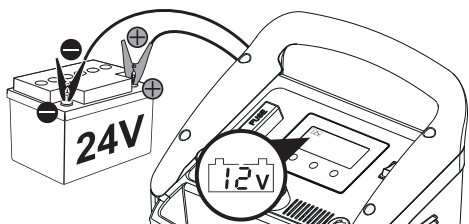

AL 4

AL 5

AL 6

AL 7

AL 8

Pulse *mm*
Tronic



AL 9

RÖVIDZÁRLAT

EQUALIZATION

DIAGNOSTIC

SUPPLY

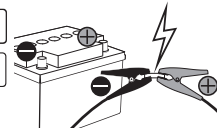

JELZÉS
TÚLMELEGEDÉS
Automatikus visszaállítás

000



RIASZTÁS
TERMIKUS

00



DISPLAY LCD (pag. 2)

1. Tensiune baterie setată.
2. Display principal: tensiune-curent măsurat al bateriei, Ah selectat, valoarea tensiunii selectate pentru programele Supply / Equalization, mesaje de interfață către operator, coduri de alarmă.
3. Alarmă pentru inversare polaritate, scurt circuit, baterie uzată sau defectă.
4. Curent și tensiune setată.
Coduri de alarmă "AL1 - AL9".
5. Nivel de încărcare a bateriei.
6. Alegere curent de încărcare PULSE-TRONIC: AUTO, BOOST, Personalizat (setare Ah).
7. Funcționare la temperaturi joase.
9. Modalitate EQUALIZATION.
10. Modalitate DESULFATION.
11. Alegere tip baterie:
WET: baterii cu plumb, electrolit lichid;
GEL: baterii cu plumb, electrolit solid;
AGM: baterii cu plumb, sigilate, electrolit pe material absorbant;
+ (CA): baterii cu plumb calciu.
12. Modalitate SUPPLY.
14. Faze încărcare PULSE-TRONIC.
15. Modalitate START.
16. Modalitate de încărcare automată.
17. Încărcare în PULSE-TRONIC.
18. Test funcționare circuit de reîncărcare (alternator).
19. Test capacitate pornire baterie - CCA.
20. Test starea încărcării bateriei.
21. VOLT - Buton setare:
- tensiunea bateriei 12/24V;
- reglare voltaj/Ah.
22. FUNCTION - Buton setare:
- ÎNCĂRCARE PULSE -TRONIC (AUTO, AUTO \star , WET, EFB, GEL, AGM +, Li);
- TEST (starea bateriei, alternator vehicul, capacitate pornire baterie);
- Programe Avansate (DESULFATION, EQUALIZATION, SUPPLY);
- reglare voltaj/Ah.
23. MODE - Buton setare:
- curent de ieșirea (AUTO, BOOST, personalizat);
- Modalitate START.

FUNȚII

- A. ÎNCĂRCARE PULSE TRONIC
- B. TEST
 - TEST STAREA ÎNCĂRCĂRII
 - TEST CAPACITATE PORNIRE BATERIE (CCA)
 - TEST ALTERNATOR
- C. ÎNTREȚINERE BATERIE
 - EGALIZARE
 - DESULFATARE
- D. ALIMENTARE
 - ALIMENTARE
- E. PORNIRE - START

INFO ALARME

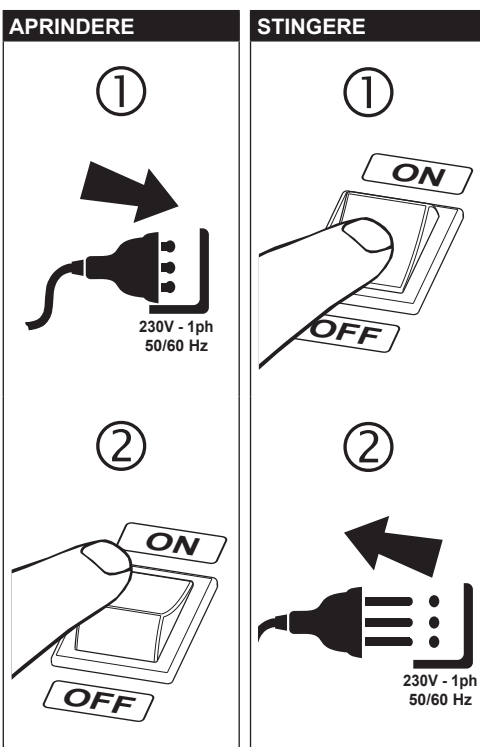

A ÎNCĂRCARE/MENȚINERE

TEHNOLOGIA PULSE-TRONIC

Pulse^{TRONIC}



1 SELECTARE PULSE-TRONIC

FUNCTION



DISPLAY

Pulse^{TRONIC}

2 SELECTARE TIP BATERIE

FUNCTION



DISPLAY

AUTO

AUTO ❄️

WET EFB GEL AGM + Li



AUTOMATĂ

AUTOMATĂ IARNĂ T<0°C

MANUALĂ

3 SELECTARE CURENTĂ

MODE



DISPLAY

AUTO

AUTO BOOST

Ah (●)



AUTOMATĂ

ÎNCĂRCARE RAPIDĂ

MANUALĂ

3A (●) SETARE Ah - EXEMPLU

MODE

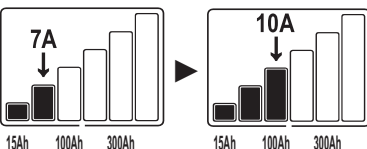

DISPLAY

85 Ah

VOLT



80Ah
75Ah
70Ah

FUNCTION



100Ah
95Ah
90Ah

4 SELECTARE TENSIUNE

VOLT



DISPLAY

12v 24v



5 CONECTARE CLEȘTI

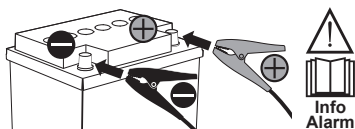

PORNIRE DUPĂ 5"

6 GRAFIC PULSE-TRONIC

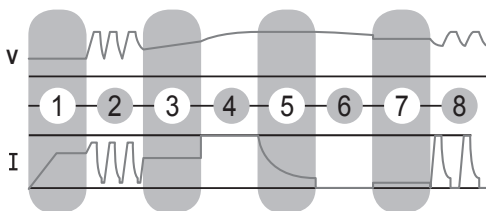

- 1 Test baterie
- 2 Recuperare baterii sulfatate/foarte descărcate
- 3 Control integritate
- 4 Încărcare până la 80%
- 5 Încărcare până la 100%
- 6 Monitorizare menținere încărcare
- 7 Menținere încărcare
- 8 Restabilire încărcare cu impulsuri

7 SFÂRȘIT ÎNCĂRCARE - EXEMPLU



B TEST

STAREA ÎNCĂRCĂRII



1 SELECTARE TEST

FUNCTION



DISPLAY
TEST



2 SELECTARE TIP BATERIE

FUNCTION



DISPLAY
WET EFB GEL AGM + Li



3 CONECTARE CLEȘTI

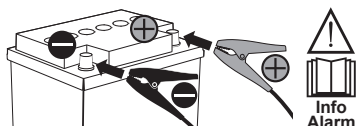

4 SELECTARE TENSIUNE

VOLT



DISPLAY

12V 24V



5 SFÂRȘIT TEST - EXEMPLU

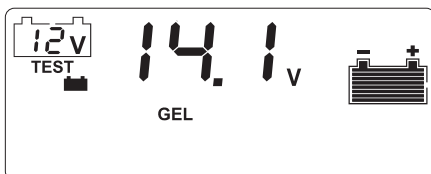

LEGENDĂ DISPLAY



B TEST

CAPACITATE PORNIRE BATERIE



1 SELECTARE TEST

FUNCTION



DISPLAY
TEST



2 CONECTARE CLEȘTI

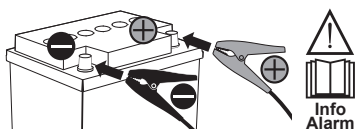

3 SELECTARE TENSIUNE

VOLT



DISPLAY

12V 24V



DISPLAY

Go

4 PORNIRE VEHICUL



5 SFÂRȘIT TEST - EXEMPLU



LEGENDĂ DISPLAY



B TEST

ALTERNATOR



1 SELECTARE TEST

FUNCTION

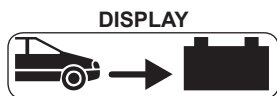

2 CONECTARE CLEȘTI

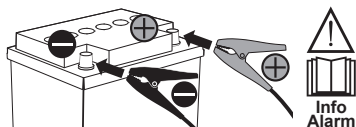

3 SELECTARE TENSIUNE

VOLT

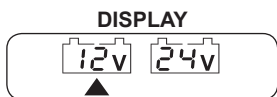

4 PORNIRE VEHICUL



5 SFÂRȘIT TEST - EXEMPLU



LEGENDĂ DISPLAY

OK	SUF	bAd
funcționează	suficient	insuficient

C ÎNTREȚINERE

DESULFATARE

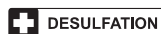

1 SELECTARE MENU AVANSAT

FUNCTION



2 SELECTARE FUNCȚIE

FUNCTION



DISPLAY



3 SELECTARE TENSIUNE

VOLT

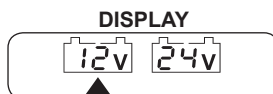

4 CONECTARE CLEȘTI

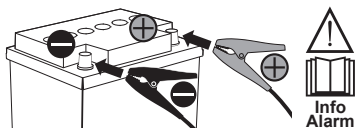

PORNIRE DUPĂ 5"

5 SFÂRȘIT PROCES - EXEMPLU

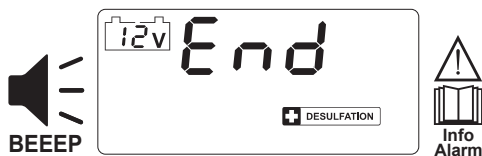

6 IEȘIRE MENU AVANSAT

FUNCTION



C ÎNTREȚINERE

EGALIZARE

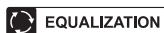

1 SELECTARE MENU AVANSAT

FUNCTION



2 SELECTARE FUNCȚIE

FUNCTION



3 SELECTARE TENSIUNE

VOLT

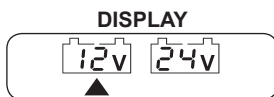

3A PERSONALIZARE TENSIUNE - EXEMPLU



VERIFICAȚI TIPUL DE BATERIE (WET, EFB, GEL, AGM +, Li) ȘI TENSIUNEA MAX. ADMISĂ.

VOLT



FUNCTION

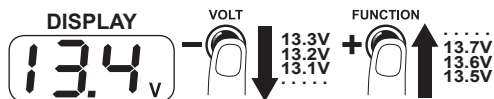

4 CONECTARE CLEȘTI

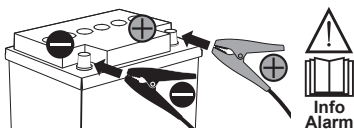

PORNIRE DUPĂ 5"

5 SFÂRȘIT PROCES - EXEMPLU

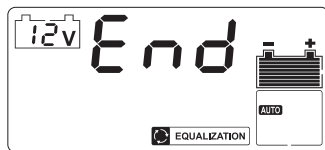

6 IEȘIRE MENU AVANSAT

FUNCTION



BLOCARE / DEBLOCARE TASTATURĂ

BLOCARE

VOLT



MODE



DISPLAY



DEBLOCARE

VOLT



MODE



DISPLAY



D ALIMENTARE

ALIMENTATOR

SUPPLY

**SCHIMBARE
BATERIE**

1 SELECTARE MENU AVANSAT

FUNCTION



2 SELECTARE FUNCȚIE

FUNCTION



DISPLAY



PREZENȚĂ TENSIUNE ÎNTRE CLEȘTI (MAX 27V).

3 SELECTARE TENSIUNE

VOLT



DISPLAY



3A PERSONALIZARE TENSIUNE - EXEMPLU



VERIFICAȚI DIN SPECIFICAȚIILE FABRICANTULUI VEICULULUI TENSIUNEA MAX. ADMISĂ.

VOLT



FUNCTION



3"

DISPLAY



VOLT



13.3V
13.2V
13.1V
.....

FUNCTION



13.7V
13.6V
13.5V

3B PERSONALIZARE CURENȚ - EXEMPLU

MODE

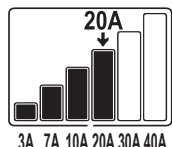
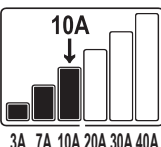

4 DISPLAY - EXEMPLU



5 CONECTARE CEȘTI LA CABLURI BATERIE VEICUL

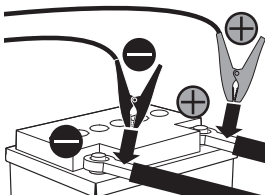

6



SCOATERE
BATERIE



ÎNLOCUIRE
BATERIE

7 IEȘIRE MENU AVANSAT

FUNCTION



3"

BLOCARE / DEBLOCARE TASTATURĂ

BLOCARE

VOLT



MODE



DISPLAY

Lok on

3"

DEBLOCARE

VOLT



MODE



DISPLAY

Lok off

3"

E PORNIRE

START

12v

1 SELECTARE FUNCȚIE

MODE



DISPLAY

START

2 SELECTARE TENSIUNE

VOLT



DISPLAY

12v 24v



Info Alarm

3 CONECTARE CLEȘTI LA BATERIE

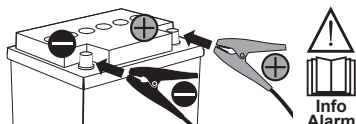

Info Alarm

DISPLAY

00

4 PORNIRE VEHICUL



5 TIMER 30" PENTRU PORNIREA SUCCESIVĂ

DISPLAY

30
29
28

6 IEȘIRE DIN FUNCȚIE

MODE



INFO ALARME



Info Alarm

AL 1

SCURT CIRCUIT

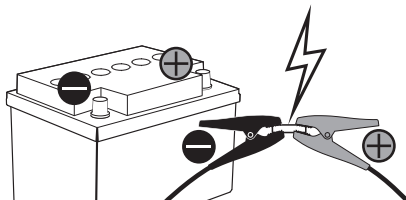

INVERSARE POLARITATE

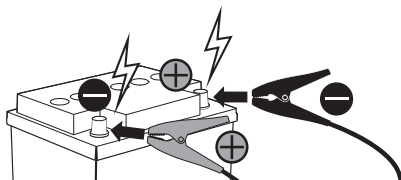

AL 2

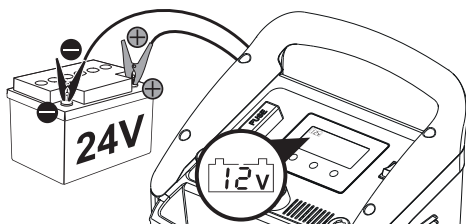

AL 4

AL 5

AL 6

AL 7

AL 8

Pulse *mm*
Tronic



AL 9

SCURT CIRCUIT

EQUALIZATION

DIAGNOSTIC

SUPPLY

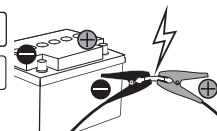

SEMNALIZARE
SUPRĂÎNCĂLZIRE
Restabilire automată

000



ALARMĂ
TERMICĂ

00



LCD-DISPLAY (sida 2)

1. Inställd batterispänning.
2. Huvuddisplay: spänning/ström som mäts för batteriet, Ah för val, vald spänning för programmen Supply / Equalization, meddelanden för gränssnitt mot operatören, larmkoder.
3. Larm för omvända poler, kortslutning, slitet eller trasigt batteri.
4. Inställd ström och spänning. Larmkoder "AL1 - AL9".
5. Batteriets laddningsnivå.
6. Val av laddningsström PULSE-TRONIC: AUTO, BOOST, Personanpassad (inställning Ah).
7. Funktion på låga temperaturer.
9. Läge EQUALIZATION.
10. Läge DESULFATION.
11. Val av batterityp:
 - WET: blybatterier, flytande elektrolyt;
 - GEL: blybatterier, sigillerade, solid elektrolyt;
 - AGM: blybatterier, sigillerade, elektrolyt på absorberande material;
 - + (CA): kalciumblybatterier.
12. Läge SUPPLY.
14. Laddningsfaser PULSE-TRONIC.
15. Läge START.
16. Automatiskt laddningsläge.
17. Laddning i PULSE-TRONIC.
18. Återladdningens funktionstest (generator).
19. Test av batteriets laddningskapacitet - CCA.
20. Batteriets laddningsstatus.
21. VOLT - Inställningsström:
 - batterispänning 12/24V;
 - spänningsreglering/Ah.
22. FUNCTION - Inställningsknapp:
 - LADDNING PULSE -TRONIC (AUTO, AUTO *, WET, EFB, GEL, AGM +, Li);
 - TEST (batteristatus, fordonets generator, batteriets laddningsförmåga);
 - Avancerade program (DESULFATION, EQUALIZATION, SUPPLY);
 - spänningsreglering/Ah.
23. MODE - Inställningsknapp:
 - utgångsström (AUTO, BOOST, personligt anpassad);
 - läge START.

FUNKTIONER

- A. LADDNING PULSE TRONIC
- B. TEST
 - TEST AV LADNINGSSTATUS
 - TEST AV BATTERIETS LADNINGSKAPACITET (CCA)
 - GENERATORTEST
- C. BATTERIUNDERHÅLL
 - UTJÄMNING
 - AVSULFATISERING
- D. EFFEKTMATNING
 - MATNING
- E. START

LARMINFORMATION

PÅSÄTTNING

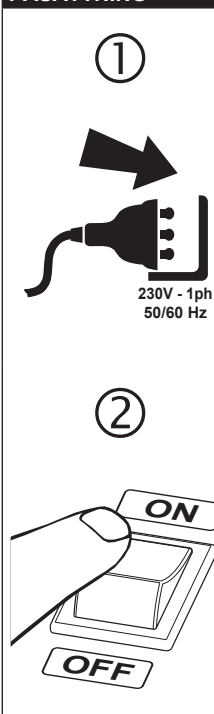

AVSTÄNGNING

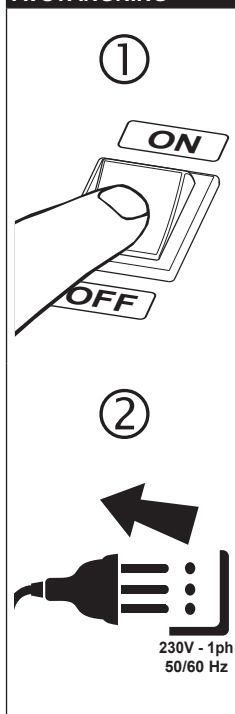

A LADDNING/UNDERHÅLL

TEKNIK PULSE-TRONIC

Pulse^{TRONIC}



1 VAL PULSE-TRONIC

FUNCTION



DISPLAY

Pulse^{TRONIC}

2 VAL AV BATTERITYP

FUNCTION



DISPLAY



AUTOMATISKT

AUTOMATISKT
VINTER T<0° C

MANUELL

3 VAL AV STRÖM

MODE



DISPLAY

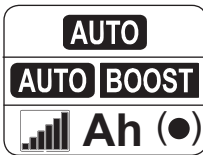

AUTOMATISKT

SNABBLADDNING

MANUELL

3A (●) INSTÄLLNING Ah - EXEMPEL

MODE

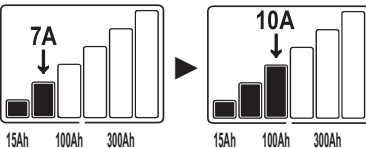

DISPLAY

85 Ah

VOLT



80Ah
75Ah
70Ah

FUNCTION



100Ah
95Ah
90Ah

4 VAL AV SPÄNNING

VOLT



DISPLAY



5 ANSLUTNING AV KLÄMMORNA

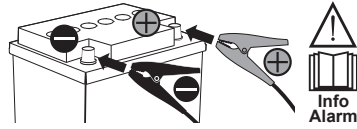

START EFTER 5 SEKUNDER

6 GRAFISK BILD PULSE-TRONIC

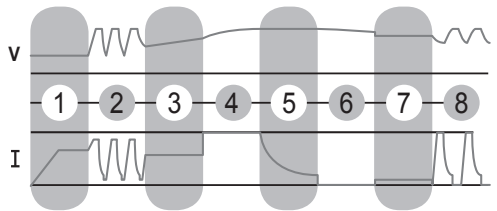

1 Batteritest

2 Återställning av sulfatbelagda/mycket urladdade batterier

3 Kontroll av helheten

4 Laddning till 80%

5 Laddning till 100%

6 Övervakning av laddningens effekt

7 Bibehållande av laddningen

8 Återställning av impulsaddningen

7 SLUT PÅ LADDNING - EXEMPEL



B TEST

LADDNINGSTATUS



1 VAL AV TEST

FUNCTION



DISPLAY
TEST



2 VAL AV BATTERITYP

FUNCTION



DISPLAY
WET EFB GEL AGM + Li



3 ANSLUTNING AV KLÄMMORNA

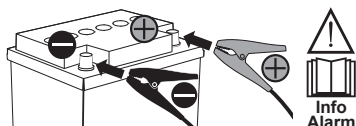

4 VAL AV SPÄNNING

VOLT

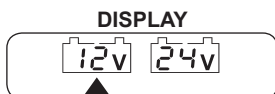

5 SLUT PÅ TEST - EXEMPEL



BILDFÖRKLARING AV DISPLAYKEN



B TEST

BATTERIETS STARTKAPACITET



1 VAL AV TEST

FUNCTION



DISPLAY
TEST



2 ANSLUTNING AV KLÄMMORNA

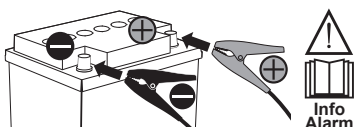

3 VAL AV SPÄNNING

VOLT

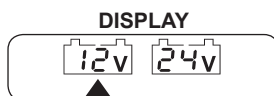

DISPLAY



4 FORDONSSTART



5 SLUT PÅ TEST - EXEMPEL



BILDFÖRKLARING AV DISPLAYKEN



B TEST

GENERATOR



1 VAL AV TEST

FUNCTION

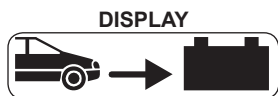

2 ANSLUTNING AV KLÄMMORNA

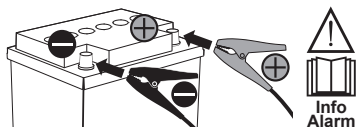

3 VAL AV SPÄNNING

VOLT

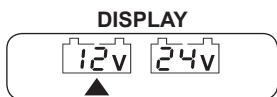

4 FORDONSSTART



5 SLUT PÅ TEST - EXEMPEL



BILDFÖRKLARING AV DISPLAYKEN

OK	SUF	bAd
fungerar	tillräcklig	otillräcklig

C UNDERHÅLL

DESULFATISERING

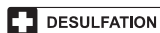

1 AVANCERATMENYVAL

FUNCTION



2 FUNKSJONSVAL

FUNCTION



3 VAL AV SPÄNNING

VOLT

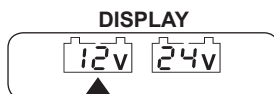

4 ANSLUTNING AV KLÄMMORNA

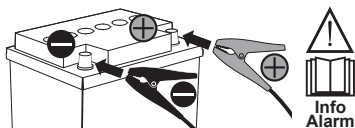

START EFTER 5 SEKUNDER

5 SLUT PÅ PROCESSEN - EXEMPEL



6 GÅ UT UR AVANCERAD MENY

FUNCTION



C UNDERHÅLL

UTJÄMNING

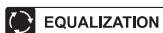

1 AVANCERATMENYVAL

FUNCTION



2 FUNKSJONSVAL

FUNCTION



3 VAL AV SPÄNNING

VOLT

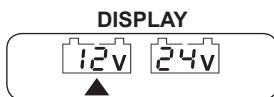

3A PERSONLIGT ANPASSAD SPÄNNING - EXEMPEL



KONTROLLERA BATTERITYPEN (WET, EFB, GEL, AGM +, Li) OCH MAX. TILLÅTEN SPÄNNING.

VOLT



FUNCTION

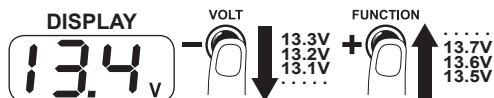

4 ANSLUTNING AV KLÄMMORNA

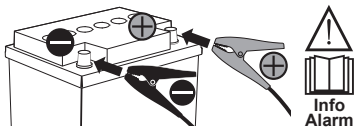

START EFTER 5 SEKUNDER

5 SLUT PÅ PROCESSEN - EXEMPEL

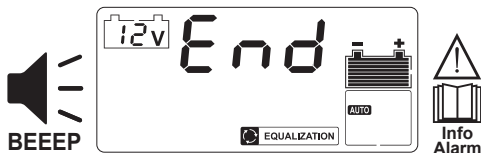

6 GÅ UT UR AVANCERAD MENY

FUNCTION



BLOCKERING/AVBLOCKERING AV TANGENTBORDET

BLOCKERING

VOLT



MODE



DISPLAY

Lok on

AVBLOCKERING

VOLT



MODE



DISPLAY

Lok off

D FÖRSÖRJNING

MATARE

SUPPLY

BATTERISPÄNNING

1 AVANCERAT MENYVAL

FUNCTION

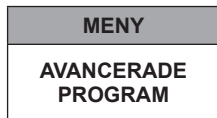

2 FUNKSJONSVAL

FUNCTION



DISPLAY



SPÄNNING FINNS MELLAN KLÄMMORNA (MAX 27V).

3 VAL AV SPÄNNING

VOLT



DISPLAY



3A PERSONLIGT ANPASSAD SPÄNNING - EXEMPEL



KONTROLLERA SPECIFIKATIONERNA FRÅN FORDONSTILLVERKARENSAMT MAX. TILLÅTEN SPÄNNING.

VOLT



FUNCTION



DISPLAY



VOLT



13.3V
13.2V
13.1V
.....

FUNCTION



13.7V
13.6V
13.5V
.....

3B PERSONLIGT ANPASSAD STRÖM - EXEMPEL

MODE

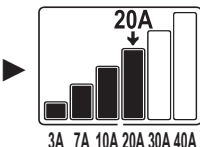
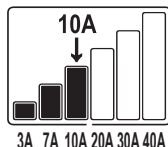

4 DISPLAY - EXEMPEL



5 ANSLUTNING AV KLÄMMORNA TILL FORDONSBATTERIETS KABLAR

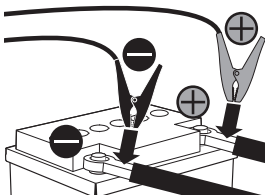

6



BORTTAGNING AV BATTERIET



BYTA BATTERIET

7 GÅ UT UR AVANCERAD MENY

FUNCTION



BLOCKERING/AVBLOCKERING AV TANGENTBORDET

BLOCKERING

VOLT



MODE



DISPLAY

Lok on

AVBLOCKERING

VOLT



MODE



DISPLAY

Lok off

E START

START

12V

1 FUNKSJONSVAL

MODE



DISPLAY

START

2 VAL AV SPÄNNING

VOLT



DISPLAY

12V 24V



Info Alarm

3 ANSLUTNING AV KLÄMMORNA TILL BATTERIET

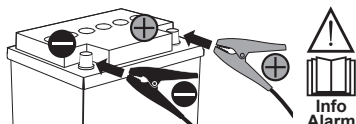

Info Alarm

DISPLAY

00

4 FORDONSSTART



5 TIMER 30 SEKUNDER FÖR NÄSTA IGÅNGSÄTTNING

DISPLAY

30
29
28

6 GÅ UT UR FUNKTIONEN

MODE



LARMINFORMATION



Info Alarm

AL 1

KORTSLUTNING

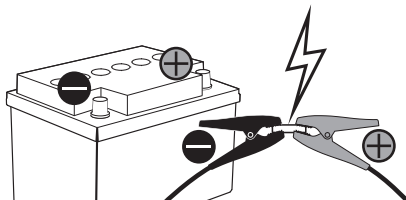

POLARITETSVÄXLING

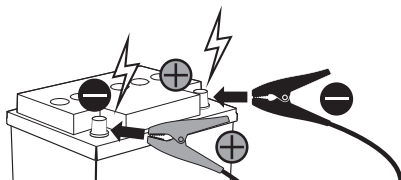

AL 2

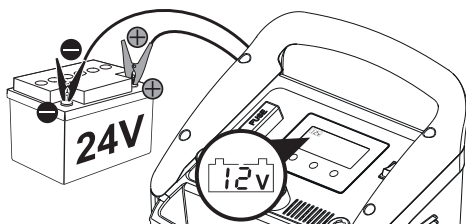

AL 4

AL 5

AL 6

AL 7

AL 8

Pulse *Tronic*



AL 9

KORTSLUTNING

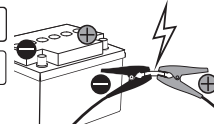

SIGNALERING
ÖVERHETTNING
Automatisk återställning

000



TERMISKT
LARM

00



LCD-DISPLAY (pag. 2)

1. Indstillet batterispænding.
2. Hoveddisplay: batteriets målte spænding-strøm, valgt Ah, spændingsværdi valgt for programmerne Supply / Equalization, interfaceddelelser til operatøren, alarmkoder.
3. Alarm for polvending, kortslutning, slidt eller defekt batteri.
4. Indstillet strøm og spænding.
Alarmkoder "AL1 - AL9".
5. Batteriets opladningsniveau.
6. Valg af ladestrøm PULSE-TRONIC: AUTO, BOOST, Brugertilpasset (indstilling Ah).
7. Funktion ved lave temperaturer.
9. Tilstand EQUALIZATION.
10. Tilstand DESULFATION.
11. Valg af batteritype:
WET: Blybatterier, flydende elektrolyt;
GEL: Blybatterier, forseglede, fast elektrolyt;
AGM: Blybatterier, forseglede, elektrolyt på absorberende materiale;
+ (CA): bly/calciumbatterier.
12. Tilstand SUPPLY.
14. Opladningsfaser PULSE-TRONIC.
15. Tilstand START.
16. Automatisk ladetilstand.
17. Opladning i PULSE-TRONIC.
18. Funktionstest for opladningskreds (generator).
19. Kapacitiv test for batteri-start - CCA.
20. Test af batteriets ladetilstand.
21. VOLT - Indstillingsknap:
 - batterispænding 12/24V;
 - regulering af spænding/Ah.
22. FUNCTION - Indstillingsknap:
 - OPLADNINGPULSE -TRONIC (AUTO, AUTO * , WET, EFB, GEL, AGM +, Li);
 - TEST (batteriets tilstand, køretøjsgenerator, batteriets startevne);
 - Avancerede programmer (DESULFATION, EQUALIZATION, SUPPLY);
 - regulering af spænding/Ah.
23. MODE - Indstillingsknap:
 - udgangsstrøm (AUTO, BOOST, brugertilpasset);
 - Tilstand START.

FUNKTIONER

- A. OPLADNING PULSE TRONIC
- B. TEST
 - TEST AF LADETILSTAND
 - TEST AF BATTERIETS STARTEVNE (CCA)
 - TEST AF GENERATOR
- C. VEDLIGEHODELSE AF BATTERIER
 - UDLIGNING
 - DESULFATERING
- D. STRØMFORSYNING
 - FORSYNING
- E. START

ALARMINFO

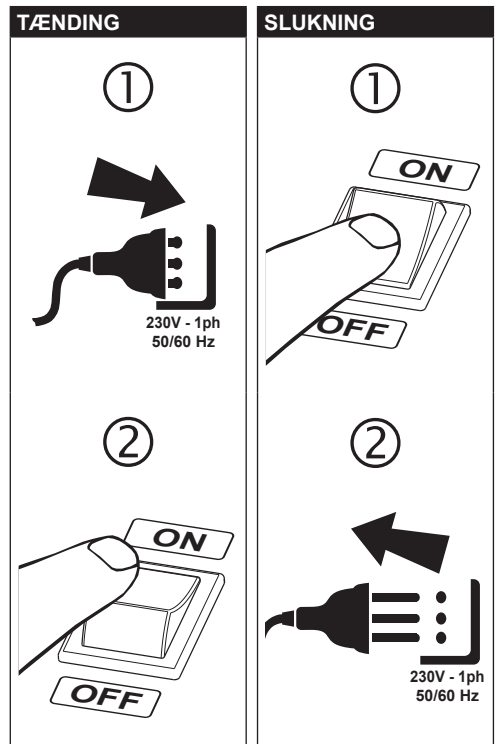

A OPLADNING/OPRETHOLDELSE

TEKNOLOGI PULSE-TRONIC

Pulse^{TRONIC}



1 VALG PULSE-TRONIC

FUNCTION



2 VALG AF BATTERITYPE

FUNCTION

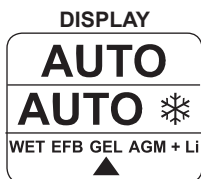

AUTOMATISK
AUTOMATISK
VINTER T<0°C
MANUEL

3 VALG AF STRØM

MODE

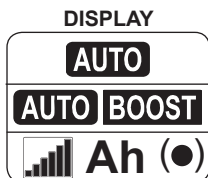

AUTOMATISK
LYNOPLADNING
MANUEL

3A (●) INDSTILLING AF Ah - EKSEMPEL

MODE

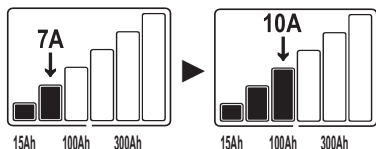

VOLT



80Ah
75Ah
70Ah

FUNCTION



100Ah
95Ah
90Ah

4 VALG AF SPÆNDING

VOLT

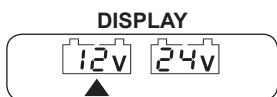

5 TILSLUTNING AF TANG

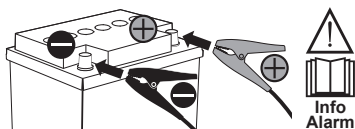

START EFTER 5"

6 GRAFIK PULSE-TRONIC

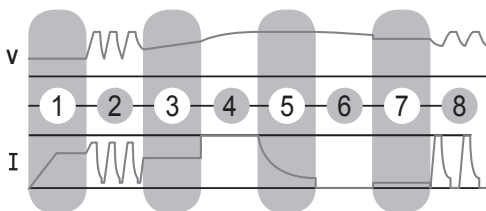

1 Test af batteri

2 Genvinding af sulfurede/næsten helt afladde batterier

3 Kontrol af intakthed

4 Opladning til 80%

5 Opladning til 100%

6 Overvågning af opretholdelse af opladningsniveau

7 Opretholdelse af opladningsniveau

8 Genopretning af opladningsniveau med impulser

7 AFSLUTNING AF OPLADNING - EKSEMPEL



B TEST

LADETILSTAND



1 VALG AF TEST

FUNCTION



DISPLAY
TEST



2 VALG AF BATTERITYPE

FUNCTION



DISPLAY
WET EFB GEL AGM + Li



3 TILSLUTNING AF TANG

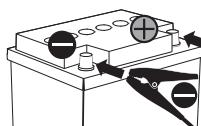

4 VALG AF SPÆNDING

VOLT



DISPLAY

12V 24V



5 AFSLUTNING AF TEST - EKSEMPEL

12V TEST

14.1 V

GEL

FORKLARINGER TIL DISPLAY



skal oplades



skal oplades



opladning

B TEST

BATTERIETS STARTEVNE



1 VALG AF TEST

FUNCTION



DISPLAY
TEST



2 TILSLUTNING AF TANG

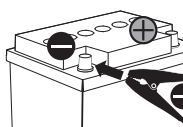

3 VALG AF SPÆNDING

VOLT



DISPLAY

12V 24V



DISPLAY

Go

4 START AF KØRETØJ



5 AFSLUTNING AF TEST - EKSEMPEL

12V TEST

OK

FORKLARINGER TIL DISPLAY

OK

fungerer

SUF

tilstrækkeligt

bAd

utilstrækkeligt

B TEST

GENERATOR



1 VALG AF TEST

FUNCTION

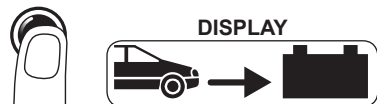

2 TILSLUTNING AF TANG

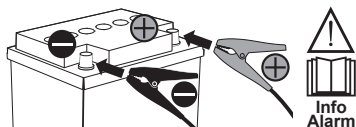

3 VALG AF SPÆNDING

VOLT

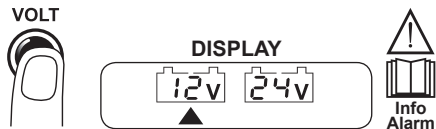

DISPLAY



4 START AF KØRETØJ



5 AFSLUTNING AF TEST - EKSEMPEL



FORKLARINGER TIL DISPLAY

OK	SUF	bAd
fungerer	tilstrækkeligt	utilstrækkeligt

C VEDLIGEHOLDELSE

DESULFATERING

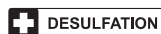

1 VALG AF AVANCERET MENU

FUNCTION



2 VALG AF FUNKTION

FUNCTION



3 VALG AF SPÆNDING

VOLT

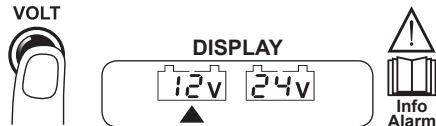

4 TILSLUTNING AF TANG

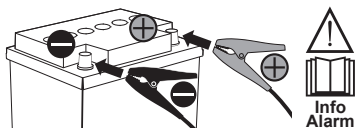

START EFTER 5"

5 AFSLUTNING AF PROCES - EKSEMPEL



6 AFSLUTNING AF AVANCERET MENU

FUNCTION



C VEDLIGEHOELSE

UDLIGNING

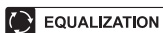

1 VALG AF AVANCERET MENU

FUNCTION



2 VALG AF FUNKTION

FUNCTION



3 VALG AF SPÆNDING

VOLT

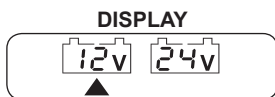

3A TIL BRUGERTILPASNING AF SPÆNDING - EKSEMPEL



KONTROLLER BATTERITYPEN (WET, EFB, GEL, AGM +, Li) OG DEN MAKS. TILLADTE SPÆNDING.

VOLT



FUNCTION

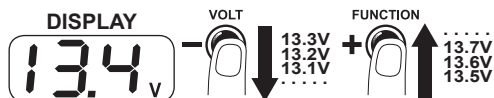

4 TILSLUTNING AF TANG

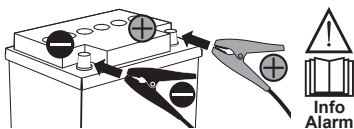

START EFTER 5"

5 AFSLUTNING AF PROCES - EKSEMPEL

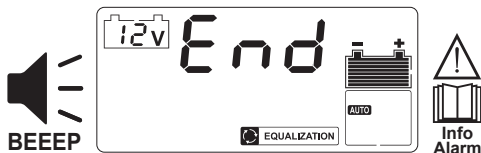

6 AFSLUTNING AF AVANCERET MENU

FUNCTION



LÅSNING / OPLÅSNING AF TASTATUR

LÅSNING

VOLT



MODE



DISPLAY

Lok on

OPLÅSNING

VOLT



MODE



DISPLAY

Lok off

D FORSYNING

FORSYNINGSENHED

SUPPLY

UDSKIFTNING
AF BATTERI

1 VALG AF AVANCERET MENU

FUNCTION

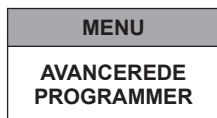

2 VALG AF FUNKTION

FUNCTION



DISPLAY



SPÆNDING TIL STEDE MELLEM TÆNGER (MAX 27V).

3 VALG AF SPÆNDING

VOLT



DISPLAY

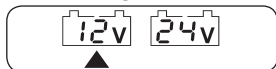

3A BRUGERTILPASNING AF SPÆNDING - EKSEMPEL



KONTROLLÉR PÅ GRUNDLAG AF KØRETØJSFABRIKANTENS SPECIFIKATIONER DEN MAKS. TILLADTE SPÆNDING.

VOLT



FUNCTION



DISPLAY



VOLT



13.3V
13.2V
13.1V

FUNCTION



13.7V
13.6V
13.5V

3B BRUGERTILPASNING AF STRØM - EKSEMPEL

MODE

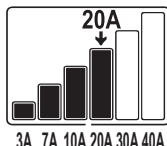
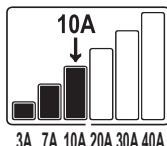

4 DISPLAY - EKSEMPEL



5 TILSLUTNING AF TÆNGER TIL KØRETØJETS BATTERIKABLER

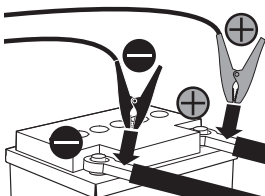

6



AFTAGNING
AF BATTERI



UDSKIFTNING
AF BATTERI

7 AFSLUTNING AF AVANCERET MENU

FUNCTION



LÅSNING / OPLÅSNING AF TASTATUR

LÅSNING

VOLT



MODE



DISPLAY

Lok on

OPLÅSNING

VOLT



MODE



DISPLAY

Lok off

E START

START

12v

1 VALG AF FUNKTION

MODE



DISPLAY

START

2 VALG AF SPÆNDING

VOLT



DISPLAY

12v 24v



Info Alarm

3 TILSLUTNING AF TÆNGERNE TIL BATTERIET

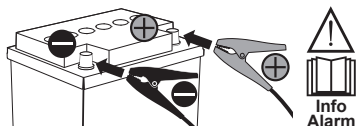

Info Alarm

DISPLAY

00

4 START AF KØRETØJ



5 TIMER 30" TIL NÆSTE START

DISPLAY

30
29
28

6 AFSLUTNING AF FUNKTION

MODE



ALARMINFO



Info Alarm

AL 1

KORTSLUTNING

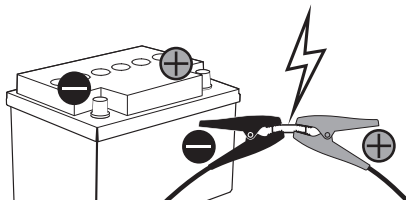

POLINVERTERING

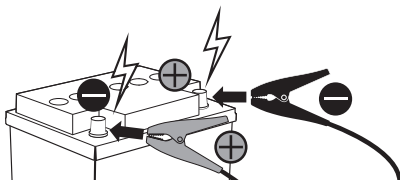

AL 2

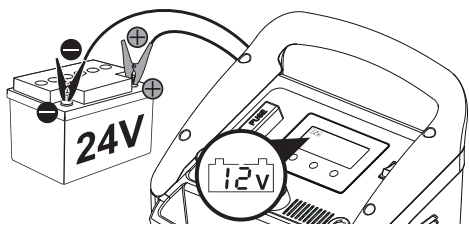

AL 4

AL 5

AL 6

AL 7

AL 8

Pulse Tronic



AL 9

KORTSLUTNING

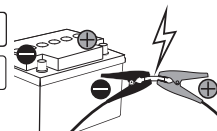

SIGNALGIVNING
OVEROPHEDNING
Automatisk genopretning

000



VARME-
ALARM

00



LCD-SKJERM (side 2)

1. Innstilt batterispenning.
2. Hovedskjerm: spenning/strøm for batteriet, Ah for valg, spenningsverdi som er valgt for programmene Supply / Equalization, meldinger om grensesnitt til operatøren, alarmkoder.
3. Alarm for omvendte poler, kortslutning, slitt eller ødelagt batteri.
4. Innstilt spenning og strøm.
Alarmkoder "AL1 - AL9".
5. Batteriets ladenivå.
6. Valg av ladestrøm PULSE-TRONIC: AUTO, BOOST, personelig tilpasning (innstilling Ah).
7. Funksjon ved lave temperaturer.
9. Modus EQUALIZATION.
10. Modus DESULFATION.
11. Valg av type batteri:
WET: blybatterier, elektrolytisk væske;
GEL: blybatterier, sigillert, solid elektrolyt;
AGM: blybatterier, sigillert, elektrolyt på absorberende materiale;
+ (CA): batterier med kalciumbly.
12. Modus SUPPLY.
14. Ladefaser PULSE-TRONIC.
15. Modus START.
16. Automatisk lademodus.
17. Lade i PULSE-TRONIC.
18. Funksjonstest av ladekretsen (generator).
19. Test av batteriets oppstartskapasitet - CCA.
20. Test av batteriets ladestatus.
21. VOLT - Innstillingsknapp:
- batterispenning 12/24V;
- spenningsregulering/Ah.
22. FUNCTION - Innstillingsknapp:
- LADING PULSE -TRONIC (AUTO, AUTO *, WET, EFB, GEL, AGM +, Li);
- TEST (batteristatus, kjøretøyets generator, batteriets ladekapasitet);
- Avanserte programmer (DESULFATION, EQUALIZATION, SUPPLY);
- spenningsregulering/Ah.
23. MODE - Innstillingsknapp:
- utgangsstrøm (AUTO, BOOST, personelig tilpasset);
- Modus START.

FUNKSJONER

- A. LADING PULSE TRONIC
- B. TEST
 - KONTROLL AV LADESTATUS
 - KONTROLL AV BATTERIETS LADEKAPASITET (CCA)
 - KONTROLL AV GENERATOREN
- C. VEDLIKEHOLD AV BATTERIENE
 - UTJEVNING
 - FJERNING AV SVOVEL
- D. TILFØRSEL
 - TILFØRSEL
- E. OPPSTART - START

INFO OM ALARMER

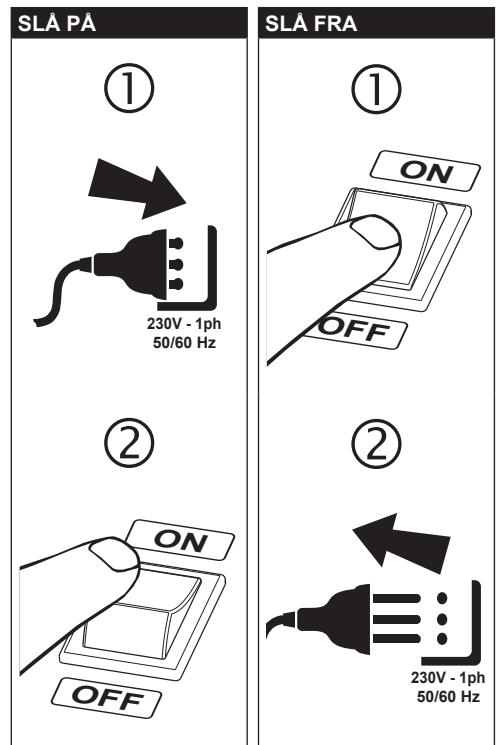

A LADING/VEDLIKEHOLD

TEKNOLOGI PULSE-TRONIC

Pulse^{TRONIC}



1 VALG AV PULSE-TRONIC

FUNCTION



SKJERM

Pulse^{TRONIC}

2 VALG AV TYPE BATTERI

FUNCTION



SKJERM



AUTOMATISK

AUTOMATISK
VINTER T<0° C

MANUELL

3 VALG AV STRØM

MODE



SKJERM



AUTOMATISK

HURTIG LADING

MANUELL

3A (●) INNSTILLING Ah - EKSEMPEL

MODE

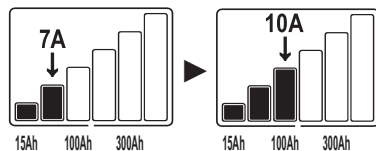

SKJERM

85 Ah

VOLT



80Ah
75Ah
70Ah

FUNCTION



100Ah
95Ah
90Ah

4 VALG AV SPENNING

VOLT



SKJERM



Info Alarm

5 KOPLING AV KLEMMER

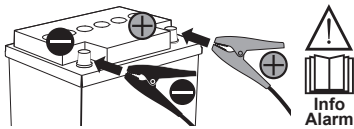

OPPSTART ETTER 5 SEKUNDER

6 GRAFISK BILDE PULSE-TRONIC

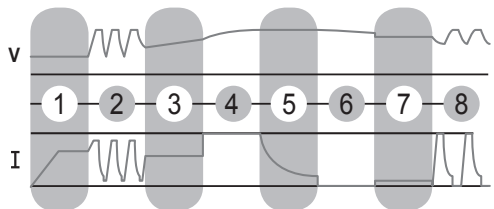

1 Batteritest

2 Gjenvinning av batterier som er sulfatbelagt/meget utladet

3 Kontroll av integriteten

4 Lading til 80%

5 Lading til 100%

6 Overvåking av at ladingen rekker

7 Ladingsvedlikehold

8 Tilbakestilling av impulsloading

7 SLUTT PÅ OPPLADING - EKSEMPEL



B TEST

LADINGSTATUS



1 VALG AV PRØVE

FUNCTION



SKJERM
TEST



2 VALG AV TYPE BATTERI

FUNCTION



SKJERM
WET EFB GEL AGM + Li



3 KOPLING AV KLEMMER

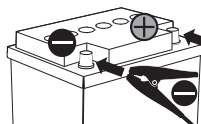

4 VALG AV SPENNING

VOLT



5 SLUTT PÅ PRØVE - EKSEMPEL



BILDEFORKLARING OM SKERJMEN



B TEST

BATTERIETS OPPSTARTKAPASITET



1 VALG AV PRØVE

FUNCTION



SKJERM
TEST



2 KOPLING AV KLEMMER

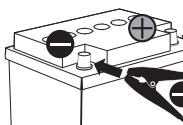

3 VALG AV SPENNING

VOLT



SKJERM



4 AVVIAMENTO STARTE FORDONET OPP



5 SLUTT PÅ PRØVE - EKSEMPEL



BILDEFORKLARING OM SKERJMEN

OK

fungerer

SUF

tilstrekkelig

bAd

ikke tilstrekkelig

B TEST

GENERATOR



1 VALG AV PRØVE

FUNCTION



SKJERM



2 KOPLING AV KLEMMER

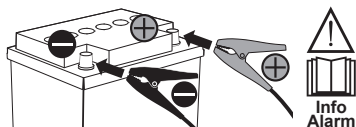

3 VALG AV SPENNING

VOLT



SKJERM



SKJERM



4 STARTE FORDONET OPP



5 SLUTT PÅ PRØVE - EKSEMPEL



BILDEFORKLARING OM SKERJMEN

OK	SUF	bAd
fungerer	tilstrekkelig	ikke tilstrekkelig

C VEDLIKEHOLD

FJERNING AV SVOVEL

DESULFATION

1 AVANSERT MENYVALG

FUNCTION



MENY

AVANSERTE
PROGRAMMER

2 VALG AV FUNKSJON

FUNCTION



SKJERM

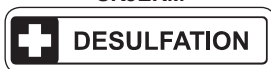

3 VALG AV SPENNING

VOLT



DISPLAY



4 KOPLING AV KLEMMER

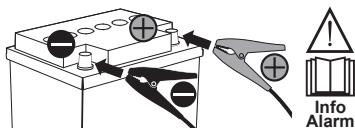

OPPSTART ETTER 5 SEKUNDER

5 SLUTT PÅ PROSESSEN - EKSEMPEL

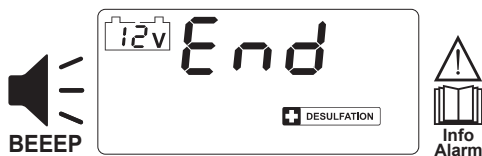

6 AVSLUTTE AVANSERT MENY

FUNCTION



3"

BEEEP

C VEDLIKEHOLD

UTJEVNING

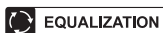

1 AVANSERT MENYVALG

FUNCTION



2 VALG AV FUNKSJON

FUNCTION

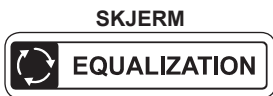

3 VALG AV SPENNING

VOLT

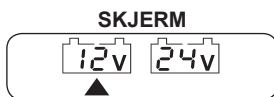

3A PERSONELIG TILPASSET SPENNING - EKSEMPEL



KONTROLLER TYPE BATERI (WET, EFB, GEL, AGM +, Li) OG MAKS. TILLATT SPENNING

VOLT



FUNCTION

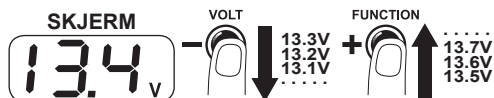

4 KOPLING AV KLEMMER

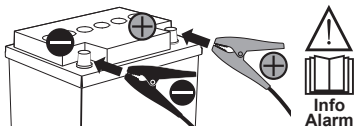

OPPSTART ETTER 5 SEKUNDER

5 SLUTT PÅ PROSESSEN - EKSEMPEL

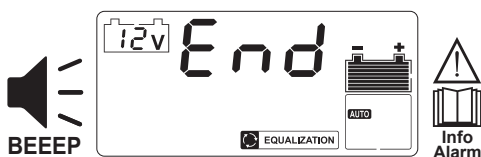

6 AVSLUTTE AVANSERT MENY

FUNCTION



BLOKKERING/AVBLOKKERING AV TASTATURET

BLOKKERING

VOLT



MODE



SKJERM

Lok on

AVBLOKKERING

VOLT



MODE



SKJERM

Lok off

D FORSYNING

FORSYNER

SUPPLY

UTSKIFTING AV BATTERI

1 AVANSERT MENYVALG

FUNCTION

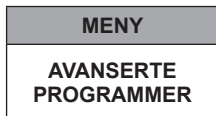

2 VALG AV FUNKSJON

FUNCTION



SKJERM



NÆRVÆR AV SPENNING MELLAN KLEMMENE (MAX 27V).

3 VALG AV SPENNING

VOLT



SKJERM



3A PERSONELIG TILPASSET SPENNING - EKSEMPEL



KONTROLLER SPESIFIKASJONENE FRA KJØRETØYETS PRODUSENT FOR Å SE MAKS. TILLATT SPENNING

VOLT



FUNCTION



SKJERM



VOLT



13.3V
13.2V
13.1V
.....

FUNCTION



13.7V
13.6V
13.5V
.....

3B PERSONELIG TILPASSET STRØM - EKSEMPEL

MODE

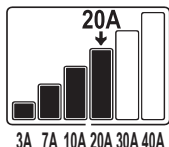
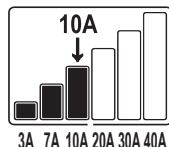

4 SKJERM - EKSEMPEL



5 KOPLING AV KLEMMENE TIL KJØRETØYETS BATTERIKABLER

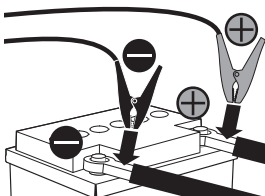

6



FJERNING AV BATTERIET



UTSKIFTING AV BATTERIET

7 AVSLUTTE AVANSERT MENY

FUNCTION



BLOKKERING/AVBLOKKERING AV TASTATURET

BLOKKERING

VOLT



MODE



SKJERM

Lok on

AVBLOKKERING

VOLT



MODE



SKJERM

Lok off

E OPPSTART

START



1 VALG AV FUNKSJON

MODE



SKJERM

START

2 VALG AV SPENNING

VOLT



SKJERM

12V 24V



Info Alarm

3 KOPLING AV KLEMMENE TIL BATTERIET

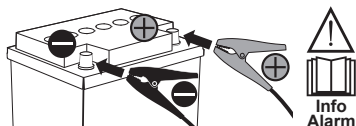

Info Alarm

SKJERM

Go

4 STARTE FORDONET OPP



5 TIMER 30 SEKUNDER TIL NESTE OPPSTART

SKJERM

30
29
28

6 GÅ UT FRA FUNKSJONEN

MODE



INFO OM ALARMER



Info Alarm

AL 1

KORTSLUTNING

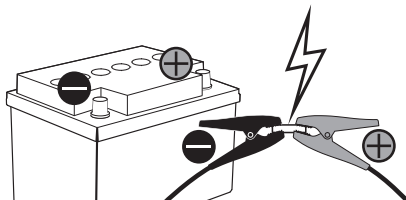

OMSTILLING POLER

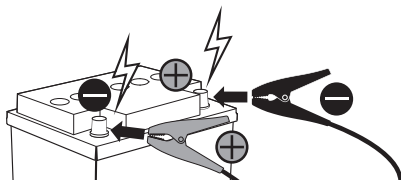

AL 2

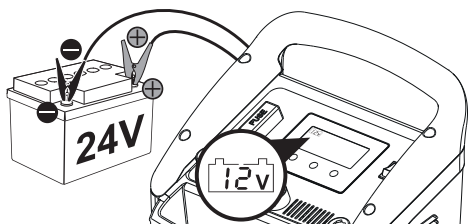

AL 4

AL 5

AL 6

AL 7

AL 8

Pulse *mm*
Tronic



AL 9

KORTSLUTNING

EQUALIZATION

DIAGNOSTIC

SUPPLY

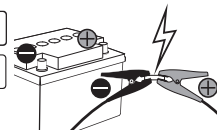

VARSLING
OVEROPPHETING
Automatisk
gjenoppretting

000 ⚠

ALARM
TERMISK

00 ⚠

NESTEKIDENÄYTTÖ (sivu 2)

1. Asetettu akun jännite.
2. Päänäyttö: akun mitattu jännite-virta, valinnan Ah, valittu jännitteen arvo ohjelmille Supply / Equalization, liitännän viestit käyttäjälle, hälytyskoodit.
3. Hälytys napaisuuden käänteisyydelle, oikosulku, kulunut tai viallinen akku.
4. Asetettu virta ja jännite.
Hälytyskoodit "AL1 - AL9".
5. Akun lataustaso.
6. Latausvirran valinta PULSE-TRONIC: AUTO, BOOST, yksilöllistetty (asetus Ah).
7. Toiminta matalilla lämpötiloilla.
9. Toimintatapa EQUALIZATION.
10. Toimintatapa DESULFATION.
11. Akkutyyppin valinta:
WET: lyijyakut, nestemäinen elektrolyytti;
GEL: lyijyakut, ilmatiiviit, kiinteä elektrolyytti;
AGM: lyijyakut, ilmatiiviit, elektrolyytti imukykyisellä materiaalilla;
+ (CA): kalsium-lyijyakut.
12. Toimintatapa SUPPLY.
14. Latausvaiheet PULSE-TRONIC.
15. Toimintatapa START.
16. Automaattisen latauksen toimintatapa.
17. Lataus toiminnossa PULSE-TRONIC.
18. Latauspiirin toimintotesti (vaihtovirtageneraattori).
19. Akun käynnistyskyvyn testi - CCA.
20. Akun lataustilan testi.
21. VOLT - Asetuspainike:
- akun jännite 12/24V;
- jännitteen säätö/Ah.
22. FUNCTION - Asetuspainike:
- LATAUS PULSE -TRONIC (AUTO, AUTO *, WET, EFB, GEL, AGM +, Li);
- TEST (akun tila, ajoneuvon vaihtovirtageneraattori, akun käynnistyskyvy);
- Edistyneet ohjelmat (DESULFATION, EQUALIZATION, SUPPLY);
- jännitteen säätö/Ah.
23. MODE - Asetuspainike:
- ulostulovirta (AUTO, BOOST, yksilöllistetty);
- Toimintatapa START.

TOIMINNOT

- A. LATAUS PULSE TRONIC
- B. TESTI
 - LATAUSTILAN TESTI
 - AKUN KÄYNNISTYSKYVYN TESTI (CCA)
 - VAIHTOVIRTAGENERAATTORIN TESTI
- C. AKKUJEN HUOLTO
 - TASAUS
 - SULFAATIN POISTO
- D. VIRRANSYÖTTÖ
 - VIRRANSYÖTTÖ
- E. KÄYNNISTYS - START

HÄLYTYSTIEDOT

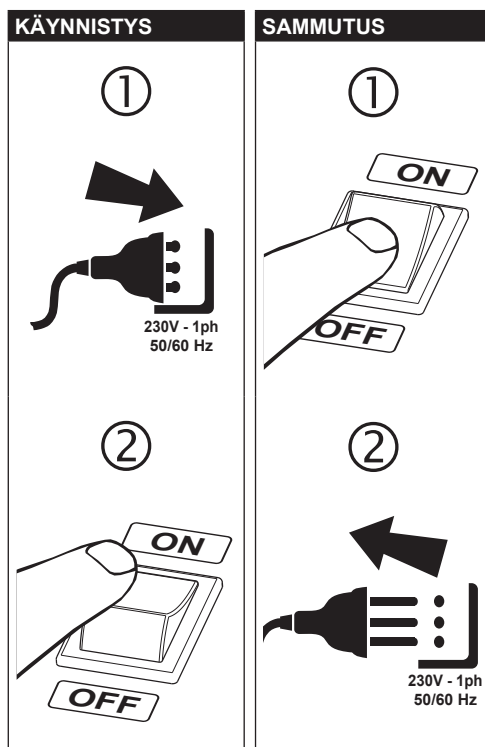

A LATAUS/YLLÄPITO

TEKNOLOGIA PULSE-TRONIC

Pulse^{TRONIC}



1 VALINTA PULSE-TRONIC

FUNCTION



NÄYTTÖ

Pulse^{TRONIC}

2 AKKUTYYPIN VALINTA

FUNCTION



NÄYTTÖ

AUTO
AUTO ❄️
WET EFB GEL AGM + Li



AUTOMAATTINEN
AUTOMAATTINEN
TALVI T<0°C
KÄSIKÄYTTÖINEN

3 VIRRAN VALINTA

MODE



NÄYTTÖ

AUTO
AUTO BOOST
Ah (●)



AUTOMAATTINEN
PIKALATAUS
KÄSIKÄYTTÖINEN

3A (●) ASETUS Ah - ESIMERKKI

MODE

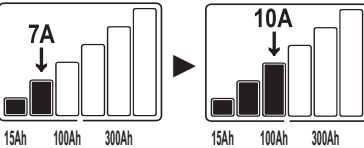

NÄYTTÖ
85 Ah

VOLT



80Ah
75Ah
70Ah

FUNCTION



100Ah
95Ah
90Ah

4 JÄNNITTEEN VALINTA

VOLT



NÄYTTÖ

12v **24v**



5 PIHTIEN LIITÄNTÄ

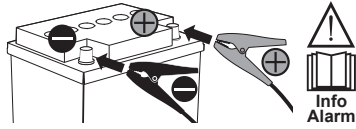

KÄYNNSTYS 5" JÄLKEEN

6 GRAAFINEN PULSE-TRONIC

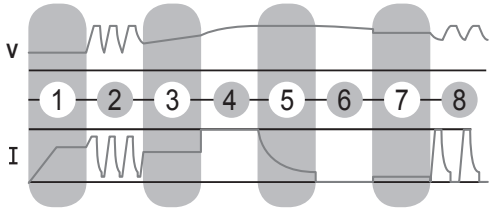

① Akun testi

② Sulfonoitujen/hyvin tyhjiä akkujen palautus

③ Eheyden tarkastus

④ Lataus 80 %:in

⑤ Lataus 100%:in

⑥ Latauksen pysyvyyden valvonta

⑦ Latauksen ylläpito

⑧ Impulssilatauksen ennalleenpalautus

7 LATAUKSEN LOPPU - ESIMERKKI



B TESTI

LATAUKSEN TILA



1 TESTIN VALINTA

FUNCTION



NÄYTTÖ
TEST



2 AKKUTYYPIN VALINTA

FUNCTION



NÄYTTÖ
WET EFB GEL AGM + Li



3 PIHTIEN LIITÄNTÄ

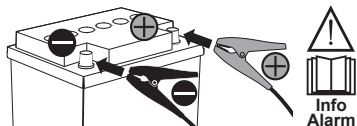

4 JÄNNITTEEN VALINTA

VOLT



NÄYTTÖ

12V 24V



5 TESTIN LOPPU - ESIMERKKI



NÄYTÖN SELITYKSET



B TESTI

AKUN KÄYNNISTYSKYKY



1 TESTIN VALINTA

FUNCTION



NÄYTTÖ
TEST



2 PIHTIEN LIITÄNTÄ

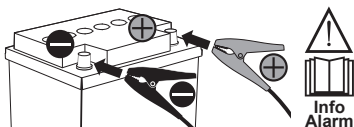

3 JÄNNITTEEN VALINTA

VOLT



NÄYTTÖ

12V 24V



NÄYTTÖ

Go

4 AJONEUVON KÄYNNISTYS



5 TESTIN LOPPU - ESIMERKKI



NÄYTÖN SELITYKSET



B TESTI

VAIHTOVIRTAGENERAATTORI  → 

1 TESTIN VALINTA

FUNCTION



2 PIHTIEN LIITÄNTÄ

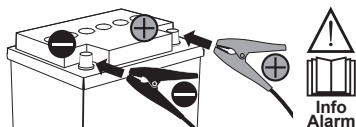

3 JÄNNITTEEN VALINTA

VOLT

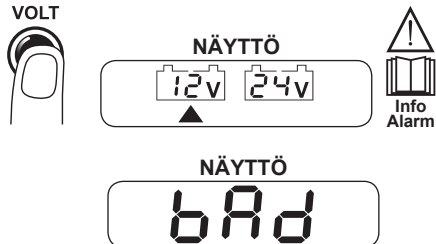

4 AJONEUVON KÄYNNISTYS



5 TESTIN LOPPU - ESIMERKKI



NÄYTÖN SELITYKSET

OK	SUF	bAd
toimiva	riittävä	riittämätön

C HUOLTO

SULFAATIN POISTO  DESULFATION

1 EDISTYNEEN VALIKON VALINTA

FUNCTION

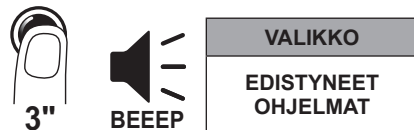

2 TOIMINNON VALINTA

FUNCTION



3 JÄNNITTEEN VALINTA

VOLT

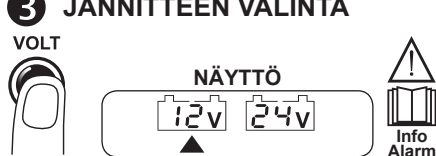

4 PIHTIEN LIITÄNTÄ

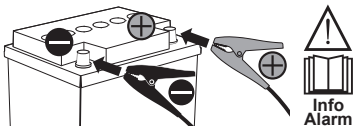

KÄYNNISTYS 5" JÄLKEEN

5 MENETELMÄN LOPPU - ESIMERKKI



6 POISTUMINEN EDISTYNEESTÄ VALIKOSTA

FUNCTION



C HUOLTO

TASAUS

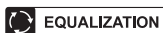

1 EDISTYNEEN VALIKON VALINTA

FUNCTION

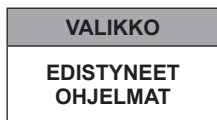

2 TOIMINNON VALINTA

FUNCTION



3 JÄNNITTEEN VALINTA

VOLT



3A JÄNNITTEEN YKSILÖLLISTÄMINEN - ESIMERKKI



TARKASTA AKKUTYYPI (WET, EFB, GEL, AGM +, Li) JA MAKSIMI. SALLITTU JÄNNITE.

VOLT



FUNCTION

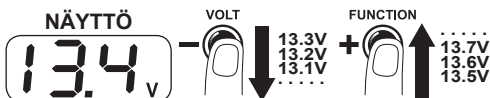

4 PIHTIEN LIITÄNTÄ

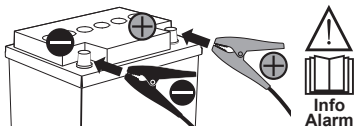

KÄYNNSTYS 5" JÄLKEEN

5 MENETELMÄN LOPPU - ESIMERKKI

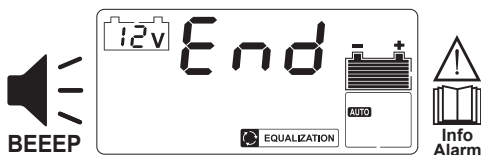

6 POISTUMINEN EDISTYNEESTÄ VALIKOSTA

FUNCTION



NÄPPÄIMISTÖN LUKITUS / AVAUS

LUKITUS

VOLT



MODE



NÄYTTÖ

Lok on

AVAUS

VOLT



MODE



NÄYTTÖ

Lok off

D VIRRANSYÖTTÖ

VIRRANSYÖTTÖLAITE

SUPPLY

AKUN
VAIHTO

1 EDISTYNEEN VALIKON VALINTA

FUNCTION

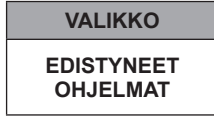

2 TOIMINNON VALINTA

FUNCTION



NÄYTTÖ

SUPPLY



JÄNNITE OLEMASSA PIHTIEN VÄLILLÄ
(MAX 27V).

3 JÄNNITTEEN VALINTA

VOLT



NÄYTTÖ

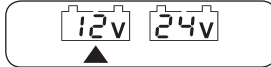

3A JÄNNITTEEN YKSILÖLLISTÄMINEN - ESIMERKKI



TARKASTAA AJONEUVON VALMISTAJAN
ERITTELYISTÄ MAKSIMI. SALLITTU
JÄNNITE.

VOLT



FUNCTION



3"

NÄYTTÖ



VOLT



13.3V
13.2V
13.1V

FUNCTION



13.7V
13.6V
13.5V

3B VIRRAN YKSILÖLLISTÄMINEN - ESIMERKKI

MODE

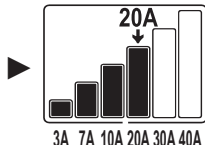
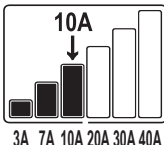

4 NÄYTTÖ - ESIMERKKI



5 PIHTIEN LIITÄNTÄ AJONEUVON AKUN KAAPELEIHIN

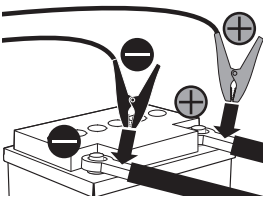

6



AKUN
POISOTTO



AKUN
VAIHTO

7 POISTUMINEN EDISTYNEESTÄ VALIKOSTA

FUNCTION



3"

NÄPPÄIMISTÖN LUKITUS / AVAUS

LUKITUS

VOLT



MODE



NÄYTTÖ

Lok on

AVAUS

VOLT



MODE



NÄYTTÖ

Lok off

E KÄYNNISTYS

START

12V

1 TOIMINNON VALINTA

MODE



NÄYTTÖ

START

2 JÄNNITTEEN VALINTA

VOLT



NÄYTTÖ

12V 24V



Info Alarm

3 PIHTIEN LIITÄNTÄ AKKUUN

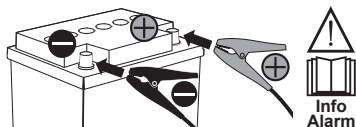

NÄYTTÖ

00

4 AJONEUVON KÄYNNISTYS



5 AJASTIN 30" SEURAAVALLE KÄYNNISTYKSELLE

NÄYTTÖ

30
29
28

6 POISTUMINEN TOIMINNOSTA

MODE



HÄLYTYSTIEDOT



Info Alarm

AL 1

OIKOSULKU

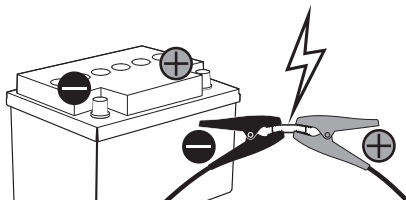

NAPAIKUUDEN KÄÄNTEISYYS

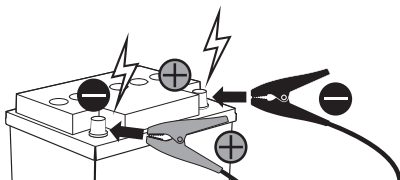

AL 2

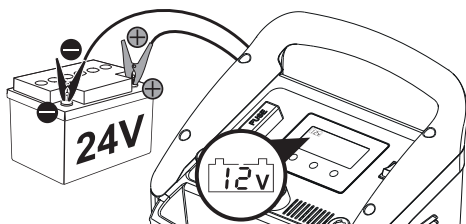

AL 4

AL 5

AL 6

AL 7

AL 8

Pulse *mm*
Tronic



AL 9

OIKOSULKU

EQUALIZATION

DIAGNOSTIC

SUPPLY

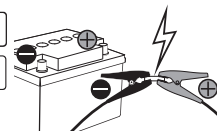

MERKINANTO
YLIKUUMENEMINEN
Automaattinen
ennalleenpalautus

LÄMPÖ-
HÄLYTYYS

000



00



LCD DISPLEJ (pag. 2)

1. Nastavené napětí akumulátoru
2. Hlavní displej: naměřené napětí-proud akumulátoru, Ah volby, napětí zvolené pro programy Supply / Equalization, hlášení uživatelského rozhraní, kódy alarmu.
3. Alarm upozorňující na záměnu polarity, zkrat, opotřebený nebo vadný akumulátor.
4. Nastavený proud a napětí.
Kódy alarmu „AL1 - AL9“.
5. Úroveň nabití akumulátoru.
6. Volba nabíjecího proudu PULSE-TRONIC: AUTO, BOOST, Uživatelsky přizpůsobena (nastavení Ah).
7. Činnost při nízkých teplotách.
9. Režim EQUALIZATION.
10. Režim DESULFATION.
11. Volba typu akumulátoru
WET: olověné akumulátory s tekutým elektrolytem;
GEL: olověné, hermeticky uzavřené akumulátory s pevným elektrolytem;
AGM: olověné, hermeticky uzavřené akumulátory s elektrolytem na absorpčním materiálu;
+ (CA): olověné-vápenaté akumulátory.
12. Režim SUPPLY.
14. Fáze nabíjení PULSE-TRONIC.
15. Režim START.
16. Režim automatického nabíjení.
17. Nabíjení v režimu PULSE-TRONIC.
18. Zkouška činnosti nabíjecího obvodu (alternátoru).
19. Zkouška startovací schopnosti akumulátoru - CCA.
20. Zkouška stavu nabití akumulátoru
21. VOLT - Nastavovací tlačítko:
- napětí akumulátoru 12/24 V;
- nastavení napětí/Ah.
22. FUNCTION - Nastavovací tlačítko:
- NABÍJENÍ PULSE-TRONIC (AUTO, AUTO \ast , WET, EFB, GEL, AGM +, Li);
- TEST (stav akumulátoru, alternátor vozidla, startovací schopnost akumulátoru);
- Pokročilé programy (DESULFATION, EQUALIZATION, SUPPLY);
- nastavení napětí/Ah.
23. MODE - Nastavovací tlačítko:
- výstupní proud (AUTO, BOOST, uživatelsky přizpůsobený);
- Režim START.

FUNKCE

- A. NABÍJENÍ PULSE TRONIC
- B. ZKOUŠKA
 - ZKOUŠKA STAVU NABITÍ
 - ZKOUŠKA STARTOVACÍ SCHOPNOSTI AKUMULÁTORU (CCA)
 - ZKOUŠKA ALTERNÁTORU
- C. ÚDRŽBA AKUMULÁTORŮ
 - VYROVNÁVÁNÍ
 - DESULFATACE
- D. NAPÁJENÍ
 - NAPÁJENÍ
- E. STARTOVÁNÍ - START

INFORMACE O ALARMECH ALLARMI

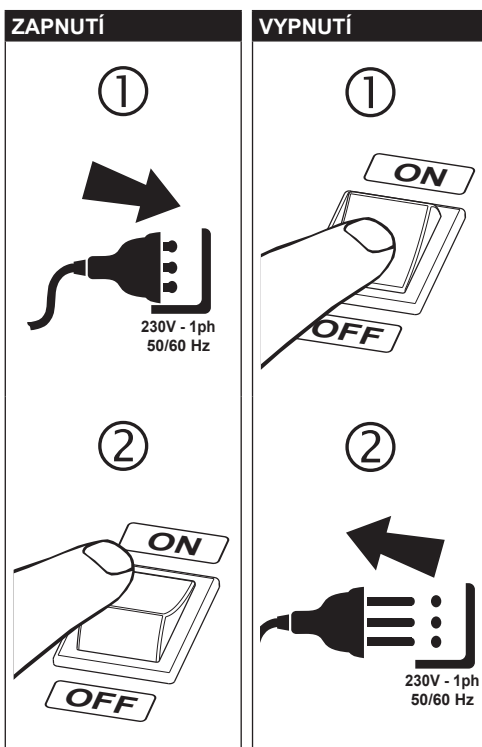

A NABÍJENÍ/UDRŽOVÁNÍ

TECHNOLOGIE PULSE-TRONIC

Pulse TRONIC



1 VOLBA PULSE-TRONIC

FUNCTION



DISPLEJ

Pulse TRONIC

2 VOLBA TYPU AKUMULÁTORU

FUNCTION



DISPLEJ

AUTO

AUTO ❄️

WET EFB GEL AGM + Li



AUTOMATICKÁ

AUTOMATICKÁ
ZIMA T < 0 °C

MANUÁLNÍ

3 VOLBA PROUDU

MODE



DISPLEJ

AUTO

AUTO BOOST

Ah (●)



AUTOMATICKÁ

RYCHLÉ NABÍTÍ

MANUÁLNÍ

3A (●) NASTAVENÍ Ah - PŘÍKLAD

MODE

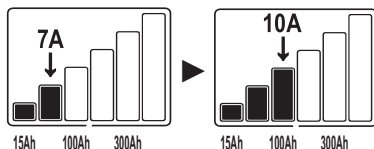

DISPLEJ

85 Ah

VOLT



80Ah
75Ah
70Ah

FUNCTION



100Ah
95Ah
90Ah

4 VOLBA NAPĚTÍ

VOLT



DISPLEJ

12v 24v



5 PŘIPOJENÍ KLEŠTÍ

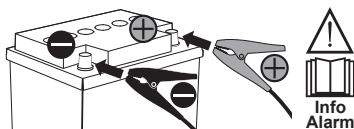

Info Alarm

SPUŠTĚNÍ PO 5"

6 GRAF PULSE-TRONIC

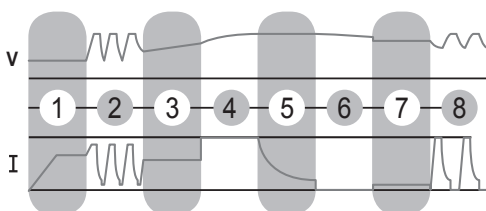

- 1 Zkouška akumulátoru
- 2 Obnovení akumulátorů, ve kterých došlo k vytvoření síranu/velmi vybitých akumulátorů
- 3 Kontrola neporušenosti
- 4 Nabít až na 80 %
- 5 Nabít až na 100 %
- 6 Monitorování udržování nabití
- 7 Udržování nabití
- 8 Impulzní obnovení nabití

7 UKONČENÍ NABÍJENÍ - PŘÍKLAD



B ZKOUŠKA

STAVU NABITÍ



1 VOLBA ZKOUŠKY

FUNCTION



DISPLEJ
TEST



2 VOLBA TYPU AKUMULÁTORU

FUNCTION



DISPLEJ
WET EFB GEL AGM + Li



3 PŘIPOJENÍ KLEŠTÍ

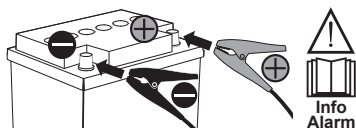

4 VOLBA NAPĚTÍ

VOLT



DISPLEJ

12V 24V



5 UKONČENÍ NABÍJENÍ - PŘÍKLAD

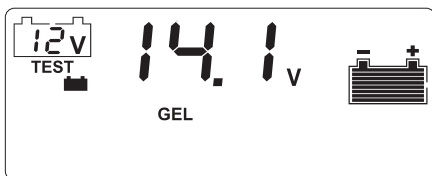

VYSVĚTLIVKY K DISPLEJI



vyžadující
nabíjení



vyžadující
nabíjení



nabíjený

B ZKOUŠKA

STARTOVACÍ SCHOPNOSTI AKUMULÁTORU



1 VOLBA ZKOUŠKY

FUNCTION



DISPLEJ
TEST



2 PŘIPOJENÍ KLEŠTÍ

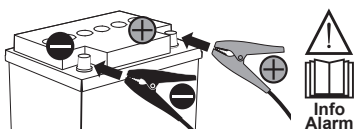

3 VOLBA NAPĚTÍ

VOLT



DISPLEJ

12V 24V



DISPLEJ

Go

4 STARTOVÁNÍ VOZIDLA



5 UKONČENÍ NABÍJENÍ - PŘÍKLAD



VYSVĚTLIVKY K DISPLEJI

OK

funkční

SUF

s dost. sch.

bAd

s nedost. sch.

B ZKOUŠKA

ALTERNÁTORU



1 VOLBA ZKOUŠKY

FUNCTION



DISPLEJ



2 PŘIPOJENÍ KLEŠTÍ

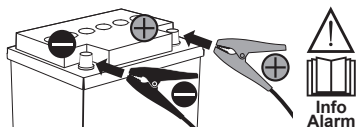

3 VOLBA NAPĚTÍ

VOLT



DISPLEJ



DISPLEJ



4 STARTOVÁNÍ VOZIDLA



5 UKONČENÍ NABÍJENÍ - PŘÍKLAD



VYSVĚTLIVKY K DISPLEJI

OK	SUF	bAd
funkční	s dost. sch.	s nedost. sch.

C ÚDRŽBA

DESULFATACE

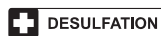

1 VOLBA POKROČILÉHO MENU

FUNCTION



MENU

POKROČILÉ
PROGRAMY

2 VOLBA FUNKCE

FUNCTION



DISPLEJ

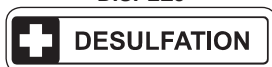

3 VOLBA NAPĚTÍ

VOLT



DISPLEJ

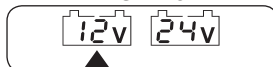

4 PŘIPOJENÍ KLEŠTÍ

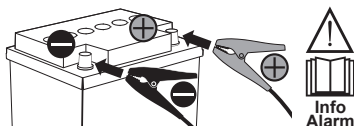

SPUŠTĚNÍ PO 5"

5 UKONČENÍ PROCESU - PŘÍKLAD



6 UKONČENÍ ZOBRAZOVÁNÍ POKROČILÉHO MENU

FUNCTION



3"

BEEEP

C ÚDRŽBA

VYROVNÁVÁNÍ

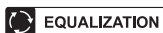

1 VOLBA POKROČILÉHO MENU

FUNCTION

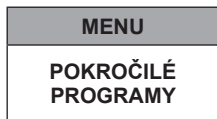

4 PŘIPOJENÍ KLEŠTÍ

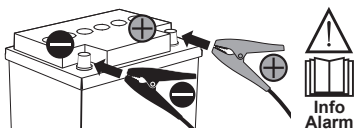

SPUŠTĚNÍ PO 5"

2 VOLBA FUNKCE

FUNCTION



DISPLEJ

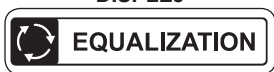

5 UKONČENÍ PROCESU - PŘÍKLAD

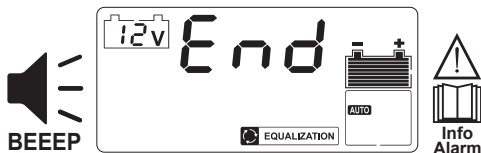

3 VOLBA NAPĚTÍ

VOLT



DISPLEJ

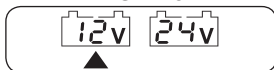

6 UKONČENÍ ZOBRAZOVÁNÍ POKROČILÉHO MENU

FUNCTION



3A UŽIVATELSKÉ PŘÍZPŮSOBENÍ NAPĚTÍ - PŘÍKLAD



ZKONTROLUJTE TYP AKUMULÁTORU (WET, EFB, GEL, AGM +, Li) a MAX. PŘÍPUSTNÉ NAPĚTÍ.

VOLT



FUNCTION



ZABLOKOVÁNÍ / ODBLOKOVÁNÍ KLÁVESNICE

ZABLOKOVÁNÍ

VOLT



MODE



DISPLEJ



ODBLOKOVÁNÍ

VOLT



MODE



DISPLEJ

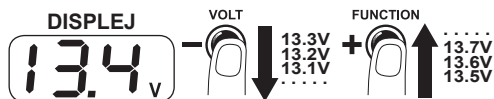

D NAPÁJENÍ

NAPÁJECÍ ZDROJ

SUPPLY

VÝMĚNA AKUMULÁTORU

1 VOLBA POKROČILÉHO MENU

FUNCTION



3"



BEEEP

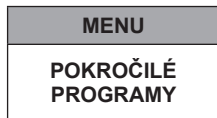

2 VOLBA FUNKCE

FUNCTION



DISPLEJ

SUPPLY



PŘÍTOMNOST NAPĚTÍ MEZI KLEŠTĚMI (MAX 27V).

3 VOLBA NAPĚTÍ

VOLT



DISPLEJ

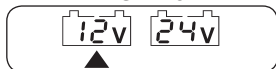

Info Alarm

3A UŽIVATELSKÉ PŘÍZPUSOBENÍ NAPĚTÍ - PŘÍKLAD



ZKONTROLUJTE PŘEDPISY VÝROBCE VOZIDLA OHLEDNĚ MAX. PŘÍPUSTNÉHO NAPĚTÍ.

VOLT



3"

FUNCTION



BEEEP

DISPLEJ



VOLT



13.3V
13.2V
13.1V

FUNCTION



13.7V
13.6V
13.5V

3B UŽIVATELSKÉ PŘÍZPUSOBENÍ PROUDU - PŘÍKLAD

MODE

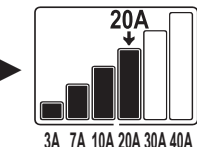
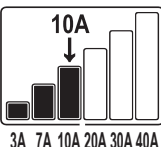

4 DISPLEJ - PŘÍKLAD



SUPPLY

5 PŘIPOJENÍ KLEŠTÍ KE KABELŮM AKUMULÁTORU VOZIDLA

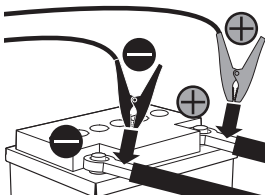

6



VYJMUTÍ AKUMULÁTORU



VÝMĚNA AKUMULÁTORU

7 UKONČENÍ ZOBRAZOVÁNÍ POKROČILÉHO MENU

FUNCTION



3"



BEEEP

ZABLOKOVÁNÍ / ODBLOKOVÁNÍ KLÁVESNICE

ZABLOKOVÁNÍ

VOLT



MODE



3"

DISPLEJ

Lok on

ODBLOKOVÁNÍ

VOLT



MODE



3"

DISPLEJ

Lok off

E STARTOVÁNÍ

START

12V

1 VOLBA FUNKCE

MODE



DISPLEJ

START

2 VOLBA NAPĚTÍ

VOLT



DISPLEJ

12V 24V



3 PŘIPOJENÍ KLEŠTÍ K AKUMULÁTORU

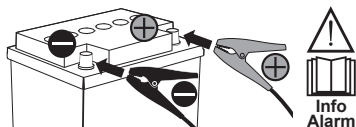

DISPLEJ

Go

4 STARTOVÁNÍ VOZIDLA



5 ČASOVAČ 30" PŘED NÁSLEDUJÍCÍM STARTOVÁNÍM

DISPLEJ

30
29
28

6 UKONČENÍ ZOBRAZOVÁNÍ FUNKCE

MODE



INFORMACE O ALARMECH



Info Alarm

AL 1

ZKRAT

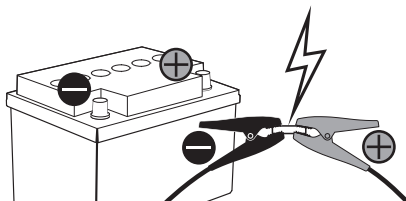

ZÁMĚNA POLARITY

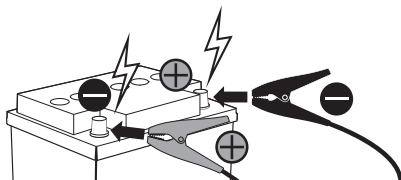

AL 2

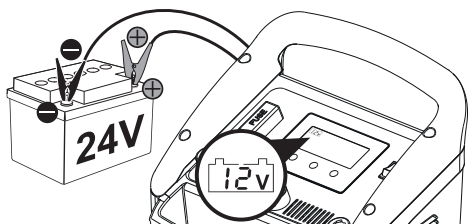

AL 4

AL 5

AL 6

AL 7

AL 8

Pulse *mm*
Tronic



AL 9

ZKRAT

EQUALIZATION

DIAGNOSTIC

SUPPLY

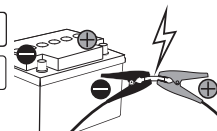

SIGNALIZACE

PŘEHŘÁTÍ
Automatické obnovení
činnosti

000



ALARM TEPELNÉ OCHRANY

0C



LCD DISPLEJ (str. 2)

1. Nastavené napätie akumulátora.
2. Hlavný displej: namerané napätie-prúd akumulátora, Ah voľby, napätie zvolené pre programy Supply / Equalization, hlásenia užívateľského rozhrania, kódy alarmu.
3. Alarm upozorňujúci na zmenu polarity, skrat, potrebovaný alebo chybný akumulátor.
4. Nastavený prúd a napätie.
Kódy alarmu „AL1 - AL9“.
5. Úroveň nabitia akumulátora.
6. Voľba nabíjacieho prúdu PULSE-TRONIC: AUTO, BOOST, Užívateľsky prispôbená (nastavenie Ah).
7. Činnosť pri nízkych teplotách
9. Režim EQUALIZATION.
10. Režim DESULFATION.
11. Voľba typu akumulátora:
WET: olovené akumulátory s tekutým elektrolytom;
GEL: olovené, hermeticky uzatvorené akumulátory, s pevným elektrolytom;
AGM: olovené, hermeticky uzatvorené akumulátory, s elektrolytom na absorpčnom materiáli;
+ (CA): oloveno-vápenaté akumulátory.
12. Režim SUPPLY.
14. Fázy nabíjania PULSE-TRONIC.
15. Režim START.
16. Režim automatického nabíjania.
17. Nabíjanie v režime PULSE-TRONIC.
18. Skúška činnosti nabíjacieho obvodu (alternátor).
19. Skúška štartovacej schopnosti akumulátora - CCA.
20. Skúška stavu nabitia akumulátora.
21. VOLT - Nastavovacie tlačidlo:
- napätie akumulátora 12/24V;
- nastavenie napätia/Ah.
22. FUNCTION - Nastavovacie tlačidlo:
- NABÍJANIE PULSE -TRONIC (AUTO, AUTO ^{*}, WET, EFB, GEL, AGM +, Li);
- TEST (stav akumulátora, alternátor vozidla, štartovacia schopnosť akumulátora);
- Pokročilé programy (DESULFATION, EQUALIZATION, SUPPLY);
- nastavenie napätia/Ah.
23. MODE - Nastavovacie tlačidlo:
- výstupný prúd (AUTO, BOOST, užívateľsky prispôbený);
- Režim START.

FUNKCIE

- A. NABÍJANIE PULSE TRONIC
- B. SKÚŠKA
 - SKÚŠKA STAVU NABITIA
 - SKÚŠKA ŠTARTOVAJEJ SCHOPNOSTI AKUMULÁTORA (CCA)
 - SKÚŠKA ALTERNÁTORA
- C. ÚDRŽBA AKUMULÁTOROV
 - VYROVNÁVANIE
 - DESULFATÁCIA
- D. NAPÁJANIE
 - NAPÁJANIE
- E. ŠTARTOVANIE - START

INFORMÁCIE O ALARMOCH

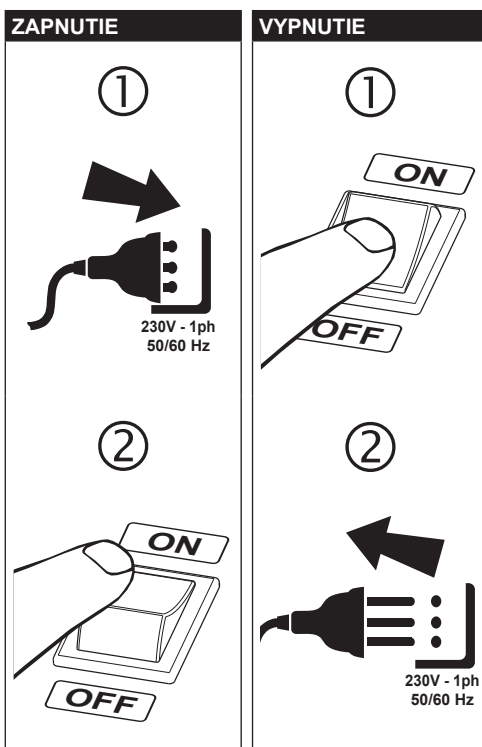

A NABÍJANIE/UDRŽIAVANIE

TECHNOLÓGIA PULSE-TRONIC

Pulseⁿⁿⁿ
Tronic



1 VOL'BA PULSE-TRONIC

FUNCTION



DISPLEJ

Pulseⁿⁿⁿ
Tronic

2 VOL'BA TYPU AKUMULÁTORA

FUNCTION



DISPLEJ



AUTOMATICKÁ

AUTOMATICKÁ
ZIMA T < 0 °C

MANUÁLNA

3 VOL'BA PRÚDU

MODE



DISPLEJ



AUTOMATICKÁ

RÝCHLE NABITIE

MANUÁLNA

3A (●) NASTAVENIE Ah - PRÍKLAD

MODE

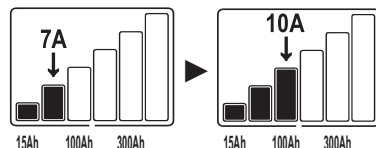

DISPLEJ

85 Ah

VOLT



80Ah
75Ah
70Ah

FUNCTION



100Ah
95Ah
90Ah

4 VOL'BA NAPÄTIA

VOLT



DISPLEJ

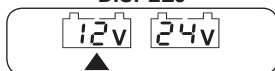

5 PRIPOJENIE KLIESTŤÍ

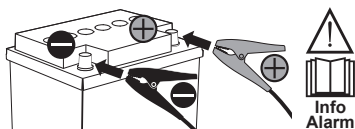

SPUSTENIE PO 5"

6 GRAF PULSE-TRONIC

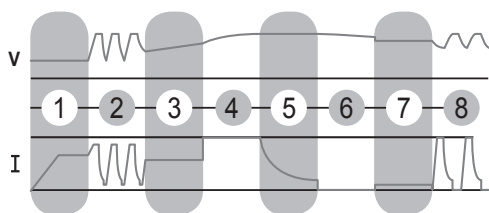

1 Skúška akumulátora

2 Obnovenie akumulátorov, v ktorých došlo k vytvoreniu síranu/veľmi vybitých akumulátorov

3 Kontrola neporušenosti

4 Nabitie až na 80 %

5 Nabitie až na 100 %

6 Monitorovanie udržiavania nabitia

7 Udržiavanie nabitia

8 Impulzné obnovenie nabitia

7 UKONČENIE NABÍJANIA - PRÍKLAD



B SKÚŠKA

STAVU NABITIA



1 VOL'BA SKÚŠKY

FUNCTION



DISPLEJ
TEST



2 VOL'BA TYPU AKUMULÁTORA

FUNCTION



DISPLEJ
WET EFB GEL AGM + Li



3 PRIPOJENIE KLIESTÍ

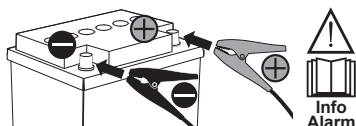

4 VOL'BA NAPÄTIA

VOLT



DISPLEJ

12V 24V



5 UKONČENIE SKÚŠKY - PRÍKLAD



VYSVETLIVKY K DISPLEJU



vyžadujúci nabitie



vyžadujúci nabitie



nabitý

B SKÚŠKA

ŠARTOVAČEJ SCHOPNOSTI AKUMULÁTORA



1 VOL'BA SKÚŠKY

FUNCTION



DISPLEJ
TEST



2 PRIPOJENIE KLIESTÍ

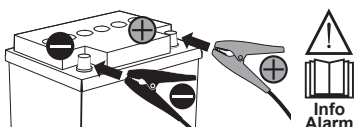

3 VOL'BA NAPÄTIA

VOLT



DISPLEJ

12V 24V



DISPLEJ

Go

4 ŠARTOVANIE VOZIDLA



5 UKONČENIE SKÚŠKY - PRÍKLAD



VYSVETLIVKY K DISPLEJU

OK

funkčný

SUF

s dost. sch.

bAd

s nedost. sch.

B SKÚŠKA

ALTERNÁTOR



1 VOL'BA SKÚŠKY

FUNCTION



DISPLEJ



2 PRIPOJENIE KLIESTÍ

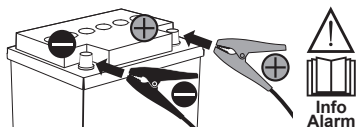

3 VOL'BA NAPÄTIA

VOLT



DISPLEJ



DISPLEJ



4 ŠARTOVANIE VOZIDLA



5 UKONČENIE SKÚŠKY - PRÍKLAD



VYSVETLIVKY K DISPLEJU

OK

funkčný

SUF

s dost. sch.

bAd

s nedost. sch.

C ÚDRŽBA

DESULFATÁCIA

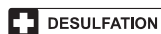

1 VOL'BA POKROČILÉHO MENU

FUNCTION



MENU

POKROČILÉ
PROGRAMY

2 VOL'BA FUNKCIE

FUNCTION



DISPLEJ

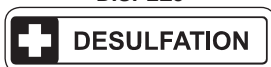

3 VOL'BA NAPÄTIA

VOLT



DISPLEJ

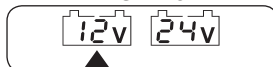

4 PRIPOJENIE KLIESTÍ

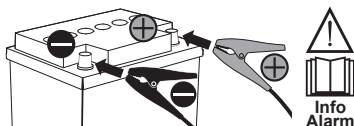

SPUSTENIE PO 5"

5 UKONČENIE PROCESU - PRÍKLAD

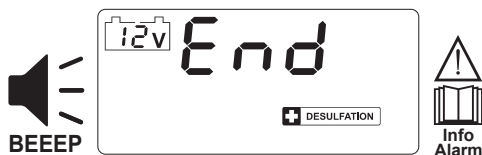

6 UKONČENIE ZOBRAZOVANIA POKROČILÉHO MENU

FUNCTION



3"

C ÚDRŽBA

VYROVNÁVANIE

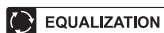

1 VOLĽBA POKROČILÉHO MENU

FUNCTION



4 PRIPOJENIE KLIEŠŤÍ

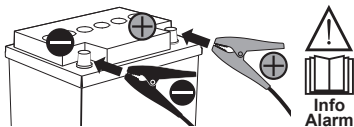

SPUSTENIE PO 5"

2 VOLĽBA FUNKCIE

FUNCTION



DISPLEJ



5 UKONČENIE PROCESU - PRÍKLAD

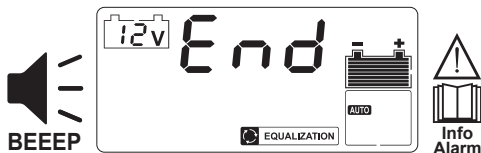

3 VOLĽBA NAPÄTIA

VOLT



DISPLEJ

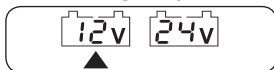

6 UKONČENIE ZOBRAZOVANIA POKROČILÉHO MENU

FUNCTION



3A UŽÍVATEĽSKÉ PRISPÔSOBENIE NAPÄTIA - PRÍKLAD



SKONTROLUJTE TYP AKUMULÁTORA (WET, EFB, GEL, AGM +, Li) a MAX. PRÍPUSTNÉ NAPÄTIE.

VOLT



FUNCTION



ZABLOKOVANIE / ODBLOKOVANIE KLÁVESNICE

ZABLOKOVANIE

VOLT



MODE



DISPLEJ



ODBLOKOVANIE

VOLT



MODE



DISPLEJ

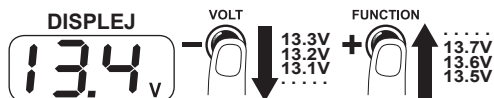

D NAPÁJANIE

NAPÁJACÍ ZDROJ

SUPPLY

VÝMENA AKUMULÁTORA

1 VOLĽBA POKROČILÉHO MENU

FUNCTION



3"



BEEEP

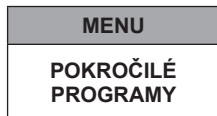

2 VOLĽBA FUNKCIE

FUNCTION



DISPLEJ



PRÍTOMNOSŤ NAPÄTIA MEDZI KLIEŠŤAMI (MAX 27V).

3 VOLĽBA NAPÄTIA

VOLT



DISPLEJ



Info Alarm

3A UŽIVATEĽSKÉ PRISPÔSOBENIE NAPÄTIA - PRÍKLAD



SKONTROLUJTE PREDPISY VÝROBCU VOZIDLA OHĽADNE MAX. PRÍPUSTNÉHO NAPÄTIA.

VOLT



3"

FUNCTION



BEEEP

DISPLEJ



VOLT



13.3V
13.2V
13.1V

FUNCTION



13.7V
13.6V
13.5V

3B UŽIVATEĽSKÉ PRISPÔSOBENIE PRÚDU - PRÍKLAD

MODE

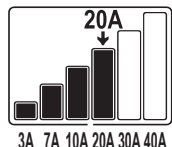
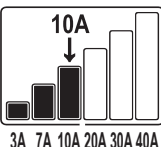

4 DISPLEJ - PRÍKLAD



SUPPLY

5 PRIPOJENIE KLIEŠŤÍ KU KÁBLM AKUMULÁTORA VOZIDLA

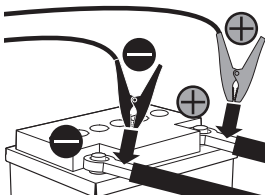

6



VYBRATIE AKUMULÁTORA



VÝMENA AKUMULÁTORA

7 UKONČENIE ZOBRAZOVANIA POKROČILÉHO MENU

FUNCTION



3"



BEEEP

ZABLOKOVANIE / ODBLOKOVANIE KLÁVESNICE

ZABLOKOVANIE

VOLT



MODE



DISPLEJ

Lok on

ODBLOKOVANIE

VOLT



MODE



DISPLEJ

Lok off

E ŠTARTOVANIE

START

12V

1 VOL'BA FUNKCIE

MODE



DISPLEJ

START

2 VOL'BA NAPÄTIA

VOLT



DISPLEJ

12V 24V



3 PRIPOJENIE KLIESTÍ K AKUMULÁTORU

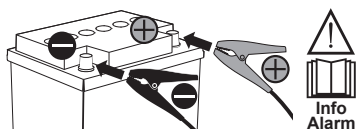

DISPLEJ

00

4 ŠTARTOVANIE VOZIDLA



5 ČASOVAČ 30" PRED NASLEDUJÚCIM ŠTARTOVANÍM

DISPLEJ

30
29
28

6 UKONČENIE ZOBRAZOVANIA FUNKCIE

MODE



INFORMÁCIE O ALARMOCH



Info Alarm

AL 1

SKRAT

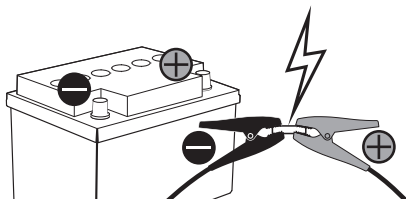

ZÁMENA POLARITY

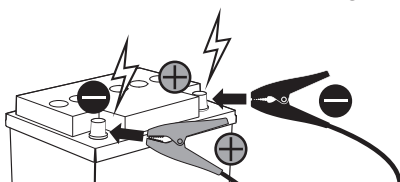

AL 2

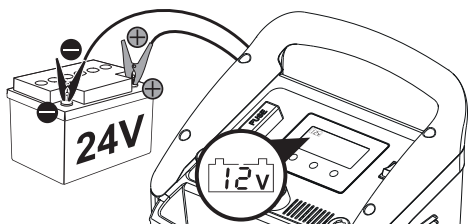

AL 4

AL 5

AL 6

AL 7

AL 8

Pulse *mm*
Tronic



AL 9

SKRAT

EQUALIZATION

DIAGNOSTIC

SUPPLY

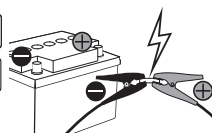

SIGNALIZÁCIA
PREHRIATIE
Automatické obnovenie
činnosti

000 ▲

ALARM
TEPELNEJ OCHRANY

0C ▲

Zaslonček LCD (str. 2)

1. Nastavljena napetost akumulatorja.
2. Glavni zaslon: izmerjena napetost-tok akumulatorja, izbrani Ah, izbrana vrednost napetosti za programe Supply / Equalization, sporočila vmesnika operaterju, kode alarmov.
3. Alarm zaradi inverzne polaritete, kratak stik, iztrošen ali pokvarjen akumulator.
4. Nastavljena tok in napetost.
Kode alarmov "AL1 - AL9".
5. Stopnja napolnjenosti akumulatorja.
6. Izbira toka za polnjenje PULSE-TRONIC: AUTO, BOOST, Osebo prilagojen (nastavitev Ah).
7. Delovanje pri nizkih temperaturah.
9. Način EQUALIZATION.
10. Način DESULFATION.
11. Izbira tipa akumulatorja:
WET: svinčevi akumulatorji, tekoči elektrolit;
GEL: zapečateni svinčevi akumulatorji, trden elektrolit;
AGM: zapečateni svinčevi akumulatorji, elektrolit na vpojnem materialu;
+ (CA): akumulatorji s svinčevim-kalcij.
12. Način SUPPLY.
14. Faza polnjenja PULSE-TRONIC.
15. Način START.
16. Način za samodejno polnjenje.
17. Polnjenje PULSE-TRONIC.
18. Preskus delovanja polnilnega vezja (alternator).
19. Preskus zmogljivosti zagona akumulatorja - CCA.
20. Preskus napolnjenosti akumulatorja.
21. VOLT - Tipka za nastavitve:
- napetost akumulatorja 12/24V;
- uravnavanje napetosti/Ah.
22. FUNCTION - Gumb za nastavitve:
- POLNENJE PULSE -TRONIC (AUTO, AUTO \star , WET, EFB, GEL, AGM +, Li);
- TEST (stanje akumulatorja, alternator vozila, zmogljivost zagona akumulatorja);
- Napredni programi (DESULFATION, EQUALIZATION, SUPPLY);
- uravnavanje napetosti/Ah.
23. MODE - Gumb za nastavitve:
- izhodni tok (AUTO, BOOST, osebno prilagojen);
- Način START.

FUNKCIJE

- A. POLNENJE PULSE TRONIC
- B. PRESKUS
 - PRESKUS STOPNJE NAPOLNJENOSTI
 - PRESKUS ZMOGLJIVOSTI ZAGONA AKUMULATORJA (CCA)
 - PRESKUS ALTERNATORJA
- C. VZDRŽEVANJE AKUMULATORJEV
 - IZRAVNAVANJE
 - DESULFATIZACIJA
- D. NAPAANJE
 - NAPAANJE
- E. ZAGON - START

INFORMACIJE O ALARMIH

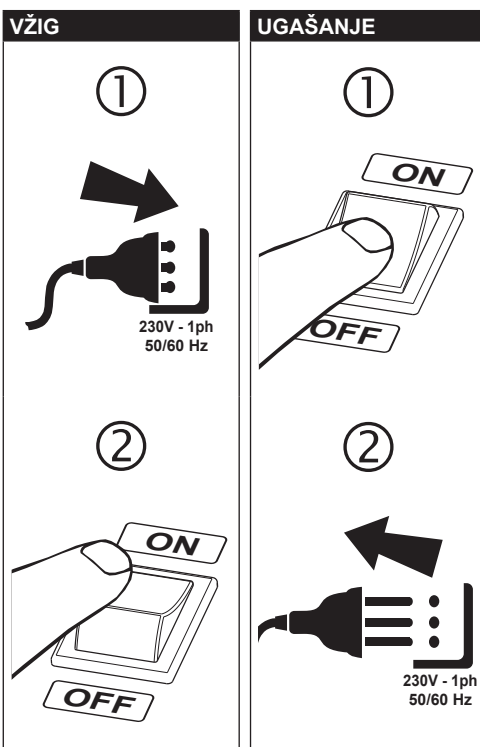

A POLNJENJE/VZDRŽEVANJE

TEHNOLOGIJA PULSE-TRONIC

Pulse^{TRONIC}



1 IZBIRA PULSE-TRONIC

FUNCTION



ZASLONČEK

Pulse^{TRONIC}

2 IZBIRA TIPA AKUMULATORJA

FUNCTION



ZASLONČEK

AUTO

AUTO ❄️

WET EFB GEL AGM + Li



SAMODEJNA

SAMODEJNA
POZIMI T<0°C

ROČNA

3 IZBIRA TOKA

MODE



ZASLONČEK

AUTO

AUTO BOOST

Ah (●)



SAMODEJNA

HITRO
POLNJENJE

ROČNA

3A (●) NASTAVITVE Ah - ZGLED

MODE

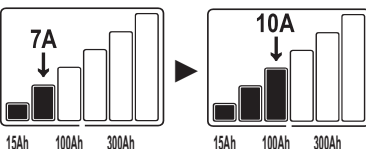

ZASLONČEK

85 Ah

VOLT



80Ah
75Ah
70Ah

FUNCTION



100Ah
95Ah
90Ah

4 IZBIRA NAPETOSTI

VOLT



ZASLONČEK

12v 24v



5 PRIKLJUČEVANJE KLEŠČ

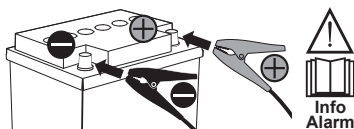

ZAGON PO 5"

6 SLIKA PULSE-TRONIC

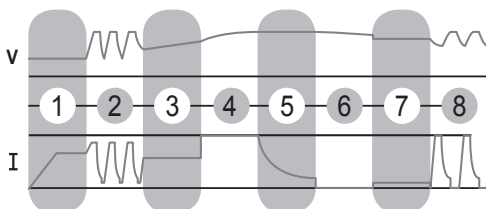

- 1 Preizkušanje akumulatorja
- 2 Povrnitev zelo sulfatiranih ali zelo praznih akumulatorjev
- 3 Preverjanje integritete
- 4 Polnjenje do 80 %
- 5 Polnjenje do 100 %
- 6 Nadzor vzdrževanja polnjenja
- 7 Vzdrževanje polnjenja
- 8 Impulzna povrnitev polnjenja v prvotno stanje

7 KONEC POLNJENJA - ZGLED



B PRESKUS

STANJE NAPOLNJENOSTI

1 IZBIRA PRESKUSA

FUNCTION



ZASLONČEK

TEST 

2 IZBIRA TIPA AKUMULATORJA

FUNCTION



ZASLONČEK

WET EFB GEL AGM + Li 

3 PRIKLJUČEVANJE KLEŠČ

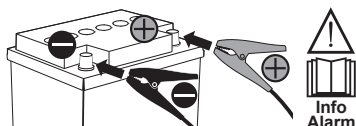

4 IZBIRA NAPETOSTI

VOLT



ZASLONČEK

12V 24V 



5 KONEC PRESKUSA - ZGLED

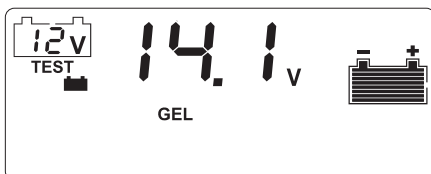

LEGENDA ZASLONČKA



B PRESKUS

ZMOGLJIVOST ZAGONA AKUMULATORJA

1 IZBIRA PRESKUSA

FUNCTION



ZASLONČEK

TEST 

2 PRIKLJUČEVANJE KLEŠČ

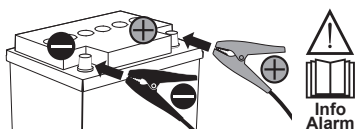

3 IZBIRA NAPETOSTI

VOLT



ZASLONČEK

12V 24V 



ZASLONČEK

00

4 ZAGON VOZILA



5 KONEC PRESKUSA - ZGLED



LEGENDA ZASLONČKA



B PRESKUS

ALTERNATOR



1 IZBIRA PRESKUSA

FUNCTION



ZASLONČEK



2 PRIKLJUČEVANJE KLEŠČ

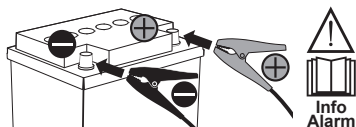

3 IZBIRA NAPETOSTI

VOLT



ZASLONČEK



ZASLONČEK



4 ZAGON VOZILA



5 KONEC PRESKUSA - ZGLED



LEGENDA ZASLONČKA

OK	SUF	bAd
delujoč	zadosten	nezadosten

C VZDRŽEVANJE

DESULFATIZACIJA

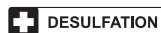

1 IZBIRA NAPREDNEGA MENUJA

FUNCTION



3" BEEEP

MENU

NAPREDNI PROGRAMI

2 IZBIRA FUNKCIJA

FUNCTION



ZASLONČEK

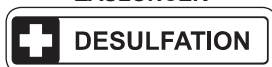

3 IZBIRA NAPETOSTI

VOLT



ZASLONČEK



4 PRIKLJUČEVANJE KLEŠČ

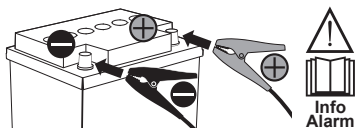

ZAGON PO 5"

5 KONEC POSTOPKA - ZGLED

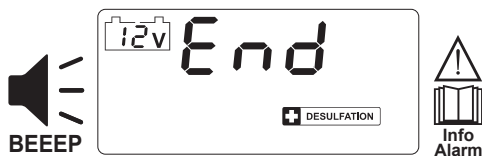

6 IZHOD IZ NAPREDNEGA MENUJA

FUNCTION



3"

BEEEP

C VZDRŽEVANJE

IZRAVNAVANJE

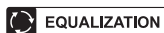

1 IZBIRA NAPREDNEGA MENUJA

FUNCTION

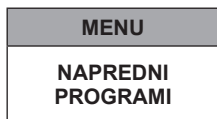

4 PRIKLJUČEVANJE KLEŠČ

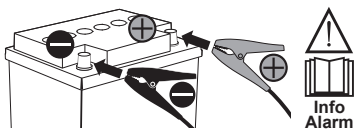

ZAGON PO 5"

2 IZBIRA FUNKCIJA

FUNCTION

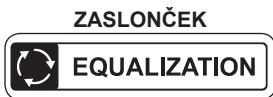

5 KONEC POSTOPKA - ZGLED

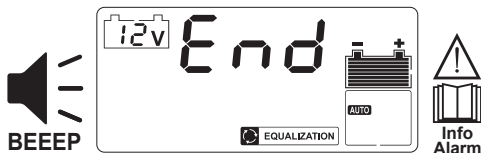

3 IZBIRA NAPETOSTI

VOLT

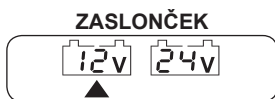

6 IZHOD IZ NAPREDNEGA MENUJA

FUNCTION



3A OSEBNA PRILAGODITEV NAPETOSTI - ZGLED

PREVERJANJE TIPA AKUMULATORJA (WET, EFB, GEL, AGM +, Li) IN MAKSIMALNA DOVOLJENA NAPETOST.

VOLT



FUNCTION



ZASLONČEK



VOLT



13.3V
13.2V
13.1V
.....

FUNCTION



.....
13.7V
13.6V
13.5V

BLOKIRANJE/ODBLOKIRANJE TIPKOVNICE

BLOKIRANJE

VOLT



MODE



ZASLONČEK



ODBLOKIRANJE

VOLT



MODE



ZASLONČEK



D NAPAJANJE

NAPAJALNIK

SUPPLY

ZAMENJAVA
AKUMULATORJA

1 IZBIRA NAPREDNEGA MENUJA

FUNCTION



3"



BEEP

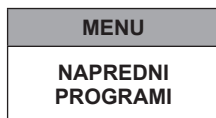

2 IZBIRA FUNKCIJA

FUNCTION



ZASLONČEK



PRISOTNOST NAPETOSTI MED
KLEŠČAMI (MAX 27V).

3 IZBIRA NAPETOSTI

VOLT



ZASLONČEK



Info
Alarm

3A OSEBNA PRILAGODITEV NAPETOSTI - ZGLED



PREVERITE V SPECIFIKACIJAH
PROIZVAJALCA VOZILA MAKSIMALNO
DOVOLJENO NAPETOST.

VOLT



FUNCTION



BEEP

3"

ZASLONČEK



VOLT



13.3V
13.2V
13.1V

FUNCTION



13.7V
13.6V
13.5V

3B OSEBNA PRILAGODITEV TOKA - ZGLED

MODE

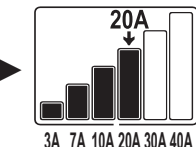
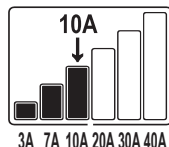

4 ZASLONČEK - ZGLED



SUPPLY

5 PRIKLJUČEVANJE KLEŠČ NA KABLIH NA AKUMULATOR VOZILA

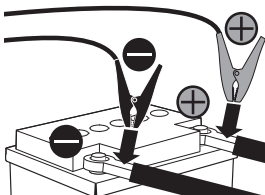

6



ODSTRANJEVANJE
AKUMULATORJA



ZAMENJAVA
AKUMULATORJA

7 IZHOD IZ NAPREDNEGA MENUJA

FUNCTION



3"



BEEP

BLOKIRANJE/ODBLOKIRANJE TIPKOVNICE

BLOKIRANJE

VOLT



MODE



ZASLONČEK

Lok on

ODBLOKIRANJE

VOLT



MODE



ZASLONČEK

Lok off

E ZAGON

START

12V

1 IZBIRA FUNKCIJA

MODE



ZASLONČEK

START

2 IZBIRA NAPETOSTI

VOLT



ZASLONČEK

12V 24V



Info Alarm

3 PRIKLJUČEVANJE KLEŠČ NA AKUMULATOR

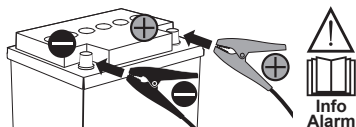

Info Alarm

ZASLONČEK

00

4 ZAGON VOZILA



5 ČASOVNIK 30" ZA NASLEDNJI ZAGON

ZASLONČEK

30
29
28

6 IZHOD IZ FUNKCIJE

MODE



INFORMACIJE O ALARMIH



Info Alarm

AL 1

KRATEK STIK

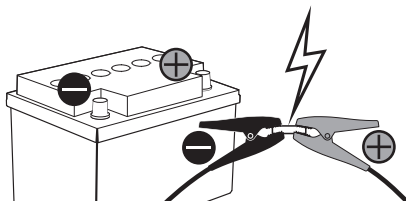

INVERZIJA POLARITETE

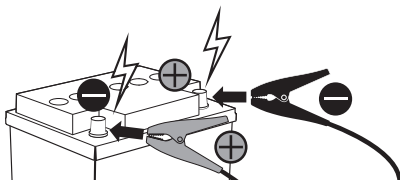

AL 2

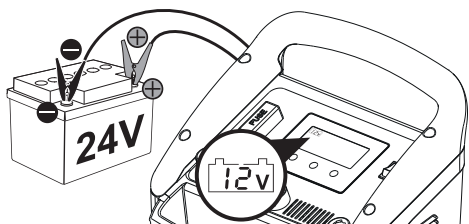

AL 4

AL 5

AL 6

AL 7

AL 8

Pulse *mm*
Tronic



AL 9

KRATEK STIK

EQUALIZATION

DIAGNOSTIC

SUPPLY

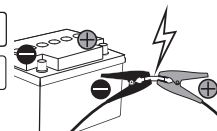

SIGNALIZACIJA PREGREVANJE
Samodejna povrnitev v prvotno stanje

000

ALARM
TERMIČNO STIKALO

00

ZASLON LCD (str. 2)

1. Napon baterije je postavljen.
2. Glavni zaslom: mjereni napon-struja baterije, odabrani Ah, odabrana vrijednost napona za programe Supply / Equalization, poruke za operatera, kodovi alarma.
3. Alarm uslijed inverzije polariteta, kratkog spoja, istrošene ili pokvarene baterije.
4. Postavljena struja i napon. Kodovi alarma "AL1 - AL9".
5. Razina punjenosti baterije.
6. Odabir struje za punjenje PULSE-TRONIC: AUTO, BOOST, Personalizirana (postavka Ah).
7. Rad na niskoj temperaturi.
9. Način rada EQUALIZATION.
10. Način rada DESULFATION.
11. Odabir vrste baterije:
WET: olovne baterije, tekući elektrolit;
GEL: zapečaćene olovne baterije, kruti elektrolit;
AGM: zapečaćene olovne baterije, elektrolit na apsorbirajućem materijalu;
+ (CA): olovne baterije kalcij.
12. Način rada SUPPLY.
14. Faze punjenja PULSE-TRONIC.
15. Način rada START.
16. Način rada di carica automatica.
17. Punjenje u PULSE-TRONIC.
18. Testirane rada sustava punjenja (alternator).
19. Testiranje kapaciteta paljenja baterije - CCA.
20. Testiranje stanja punjenosti baterije.
21. VOLT - Tipka za postavku:
 - napon baterije 12/24V;
 - regulacija voltaže/Ah.
22. VOLT - Tipka za postavku:
 - PUNJENJE PULSE -TRONIC (AUTO, AUTO ^{*}, WET, EFB, GEL, AGM +, Li);
 - TEST (stanje baterije, alternator vozila, kapacitet paljenja baterije);
 - Napredni programi (DESULFATION, EQUALIZATION, SUPPLY);
 - regulacija voltaže/Ah.
23. MODE - Tipka za postavku:
 - izlazna struja (AUTO, BOOST, personalizirana);
 - Način rada START.

FUNKCIJE

- A. PUNJENJE PULSE TRONIC
- B. TESTIRANJE
 - TESTIRANJE STANJA PUNJENOSTI
 - TESTIRANJE KAPACITETA POKRETANJA BATERIJE (CCA)
 - TESTIRANJE ALTERNATORA
- C. ODRŽAVANJE BATERIJA
 - EKUALIZACIJA
 - DESULFATIZACIJA
- D. NAPAJANJE
 - NAPAJANJE
- E. PALJENJE - START

INFO ALARMI

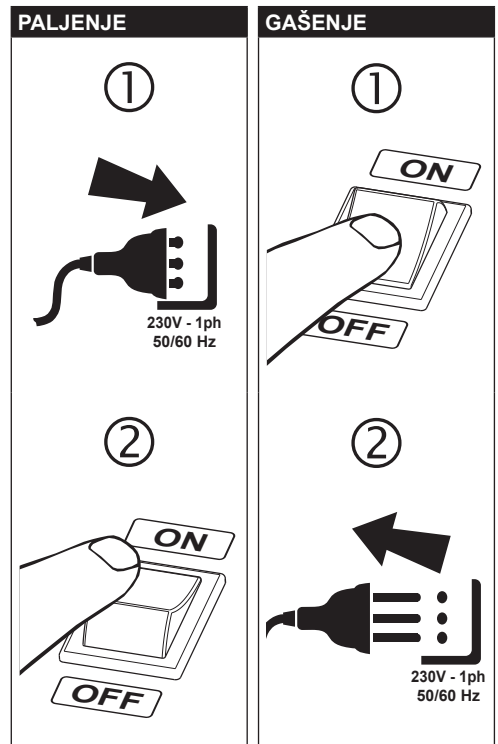

A PUNJENJE/ODRŽAVANJE

TEHNOLOGIJA PULSE-TRONIC

Pulse^{TRONIC}



1 ODABIR PULSE-TRONIC

FUNCTION



ZASLON

Pulse^{TRONIC}

2 ODABIR VRSTE BATERIJE

FUNCTION



ZASLON

AUTO

AUTO ❄️

WET EFB GEL AGM + Li



AUTOMATSKI

AUTOMATSKI
ZIMA T<0°C

RUČNO

3 TRENUTNI ODABIR

MODE



ZASLON

AUTO

AUTO BOOST

Ah (●)



AUTOMATSKI

BRZO
PUNJENJE

RUČNO

3A (●) POSTAVKA Ah - PRIMJER

MODE

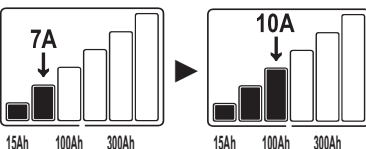

ZASLON

85 Ah

VOLT



80Ah
75Ah
70Ah

FUNCTION



100Ah
95Ah
90Ah

4 ODABIR NAPONA

VOLT



ZASLON

12v 24v



5 SPAJANJE HVATALJKI

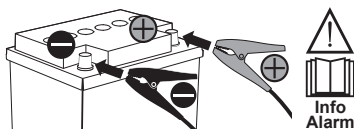

PALJENJE NAKON 5"

6 GRAFIKON PULSE-TRONIC

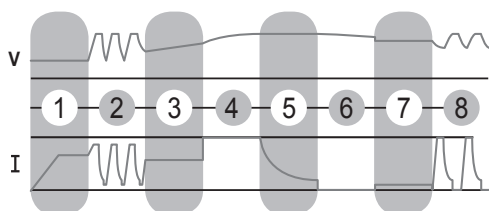

- 1 Testiranje baterije
- 2 Ponovnog osposobljavanje sulfatiranih/vrlo praznih baterija
- 3 Provjera čitavosti
- 4 Punjenje do 80%
- 5 Punjenje do 100%
- 6 Praćenje održivosti punjenja
- 7 Održavanje punjenosti
- 8 Osposobljavanje punjanja na impulse

7 KRAJ PUNJENJA - PRIMJER



B TESTIRANJE

STANJE PUNJENOSTI



1 ODABIR TESTIRANJA

FUNCTION



ZASLON
TEST



2 ODABIR VRSTE BATERIJE

FUNCTION



ZASLON
WET EFB GEL AGM + Li



3 SPAJANJE HVATALJKI

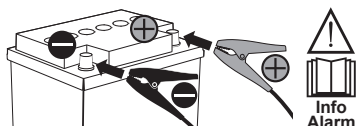

4 ODABIR NAPONA

VOLT



ZASLON
12V 24V



5 KRAJ TESTIRANJA - PRIMJER



LEGENDA ZASLON



B TESTIRANJE

KAPACITET PALJENJA BATERIJE



1 ODABIR TESTIRANJA

FUNCTION



ZASLON
TEST



2 SPAJANJE HVATALJKI

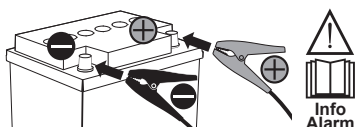

3 ODABIR NAPONA

VOLT



ZASLON

12V 24V



ZASLON

Go

4 PALJENJE VOZILA



5 KRAJ TESTIRANJA - PRIMJER



LEGENDA ZASLON



B TESTIRANJE

ALTERNATOR



1 ODABIR TESTIRANJA

FUNCTION



ZASLON



2 SPAJANJE HVATALJKI

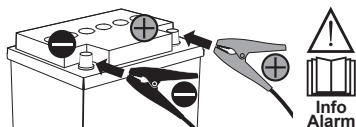

3 ODABIR NAPONA

VOLT



ZASLON



ZASLON



4 PALJENJE VOZILA



5 KRAJ TESTIRANJA - PRIMJER



LEGENDA ZASLON

OK	SUF	bAd
radi	dovoljno	nedovoljno

C SERVISIRANJE

DESULFATIZACIJA

DESULFATION

1 ODABIR NAPREDNOG MENIJA

FUNCTION



3"

BEEEP

MENI

NAPREDNI
PROGRAMI

2 ODABIR FUNKCIJE

FUNCTION



ZASLON

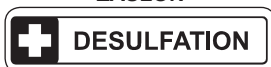

3 ODABIR NAPONA

VOLT



ZASLON

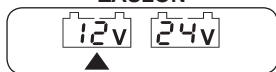

4 SPAJANJE HVATALJKI

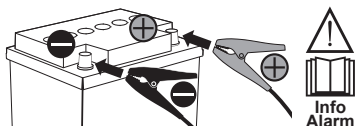

PALJENJE NAKON 5"

5 KRAJ PROCESA - PRIMJER



BEEEP



6 IZLAZ IZ NAPREDNOG MENIJA

FUNCTION



3"

BEEEP

C SERVISIRANJE

EKUALIZACIJA

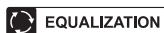

1 ODABIR NAPREDNOG MENIJA

FUNCTION

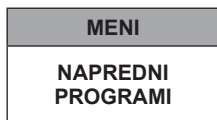

2 ODABIR FUNKCIJE

FUNCTION

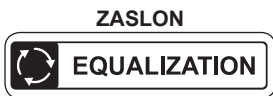

3 ODABIR NAPONA

VOLT



3A PERSONALIZACIJA NAPONA – PRIMJER



PROVJERITI VRSTU BATERIJE (WET, EFB, GEL, AGM +, Li) I MAKSIMALNI PRIHVATLJIVI NAPON.

VOLT



FUNCTION

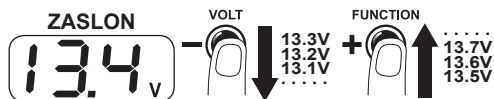

4 SPAJANJE HVATALJKI

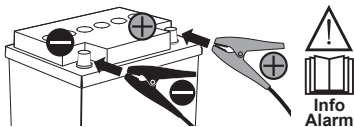

PALJENJE NAKON 5"

5 KRAJ PROCESA - PRIMJER

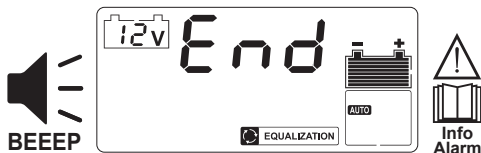

6 IZLAZ IZ NAPREDNOG MENIJA

FUNCTION



BLOKIRANJE/ODBLOKIRANJE TIPKOVNICE

BLOKIRANJE

VOLT



MODE



ZASLON

Lok on

ODBLOKIRANJE

VOLT



MODE



ZASLON

Lok off

D NAPAJANJE

UREĐAJ ZA NAPAJANJE

SUPPLY

PROMJENA BATERIJE

1 ODABIR NAPREDNOG MENIJA

FUNCTION



3"



BEEEP

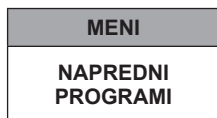

2 ODABIR FUNKCIJE

FUNCTION



ZASLON



PRISUTNOST NAPONA MEĐU HVATALJKAMA (MAX 27V).

3 ODABIR NAPONA

VOLT



ZASLON



Info Alarm

3A PERSONALIZACIJA NAPONA - PRIMJER



PROVJERITI MEĐU TEHNIČKIM PODACIMA PROIZVOĐAČA VOZILA KOJI JE MAKSIMALNI PRIHVATLJIVI NAPON.

VOLT



3"

FUNCTION



BEEEP

ZASLON



VOLT



13.3V
13.2V
13.1V

FUNCTION



13.7V
13.6V
13.5V

3B PERSONALIZACIJA STRUJE - PRIMJER

MODE

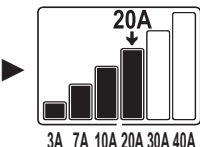
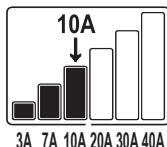

4 ZASLON - PRIMJER



SUPPLY

5 SPAJANJE HVATALJKI NA KABLOVE BATERIJE VOZILA

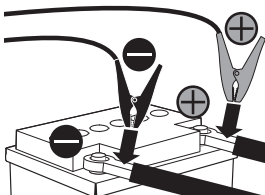

6



UKLANJANJE BATERIJE



ZAMJENA BATERIJE

7 IZLAZ IZ NAPREDNOG MENIJA

FUNCTION



3"



BEEEP

BLOKIRANJE/ODBLOKIRANJE TIPKOVNICE

BLOKIRANJE

VOLT



MODE



3"

ZASLON

Lok on

ODBLOKIRANJE

VOLT



MODE



3"

ZASLON

Lok off

E PALJENJE

START

12V

1 ODABIR FUNKCIJE

MODE



ZASLON

START

2 ODABIR NAPONA

VOLT



ZASLON

12V 24V



Info Alarm

3 SPAJANJE HVATALJKI NA BATERIJE

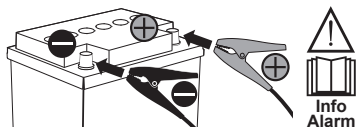

Info Alarm

ZASLON

00

4 PALJENJE VOZILA



5 TIMER 30" ZA NAKNADNO PALJENJE

ZASLON

30
29
28

6 IZLAZ IZ FUNKCIJE

MODE



INFO ALARMI



Info Alarm

AL 1

KRATAK SPOJ

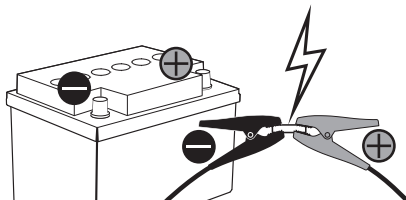

ZAMJENA POLOVA

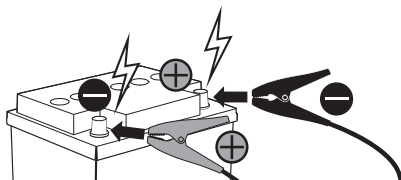

AL 2

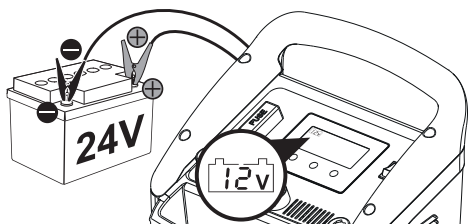

AL 4

AL 5

AL 6

AL 7

AL 8

Pulse *mm*
Tronic



AL 9

KRATAK SPOJ

EQUALIZATION

DIAGNOSTIC

SUPPLY

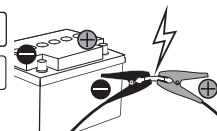

DOJAVA PREGRIJAVANJA
Automatsko uspostavljanje
prethodnog stanja

000



TOPLINSKI
ALARM

00



LCD EKRANAS (2 pusl.)

1. Nustatyta akumulatoriaus įtampa.
2. Pagrindinis ekranas: išmatuota akumulatoriaus įtampa-srovė, pasirinkimo Ah, programoms Supply / Equalization pasirinktas įtampos dydis, sąsajos pranešimai operatoriui, signalinių pranešimų kodai.
3. Signalinis pranešimas apie polių inversiją, trumpąjį sujungimą, susinaudojusį arba sugedusį akumuliatorių.
4. Nustatyta srovė ir įtampa.
Signalinių pranešimų kodai "AL1 - AL9".
5. Akumulatoriaus įkrovos lygis.
6. Įkrovimo srovės PULSE-TRONIC pasirinkimas: AUTO, BOOST, Personalizuota (nustatymasAh).
7. Veikimas prie žemos temperatūros.
9. Režimas EQUALIZATION.
10. Režimas DESULFATION.
11. Akumulatoriaus tipo pasirinkimas:
WET: švino akumuliatoriai, skystasis elektrolitas;
GEL: švino akumuliatoriai, hermetiški, kietasis elektrolitas;
AGM: švino akumuliatoriai, hermetiški, sugerianti elektrolito medžiaga;
+ (CA): švino- kalcio akumuliatoriai.
12. Režimas SUPPLY.
14. Įkrovos PULSE-TRONIC fazės.
15. Režimas START.
16. Automatinės įkrovos režimas.
17. Įkrova PULSE-TRONIC.
18. Įkrovimo grandinės (generatoriaus) veikimo testas.
19. Akumulatoriaus startinio galingumo testas - CCA.
20. Akumulatoriaus įkrovimo būsenos testas.
21. VOLT - Nustatymo mygtukas:
- akumulatoriaus įtampa 12/24V;
- įtampos reguliavimas/Ah.
22. FUNCTION - Nustatymo mygtukas:
- ĮKROVIMAS PULSE -TRONIC (AUTO, AUTO *, WET, EFB, GEL, AGM +, Li);
- TESTAS (akumulatoriaus būseną, transporto priemonės generatoriaus, akumulatoriaus startinis galingumas);
- Išplėstinės programos (DESULFATION, EQUALIZATION, SUPPLY);
- įtampos reguliavimas/Ah.
23. MODE - Nustatymo mygtukas:
- išėjimo srovė (AUTO, BOOST, personalizuota);
- Režimas START.

FUNKCIJOS

- A. ĮKROVIMAS PULSE TRONIC
- B. TESTAS
- ĮKROVIMO BŪSENOS TESTAS
- AKUMULATORIAUS STARTINIO GALINGUMO TESTAS (CCA)
- GENERATORIAUS TESTAS
- C. AKUMULATORIAUS TECHNINĖ PRIEŽIŪRA
- IŠLYGINIMAS
- DESULFATAVIMAS
- D. TIEKIMAS
- MAITINIMAS
- E. PALEIDIMAS - START

PERSPĖJIMO SIGNALŲ INFORMACIJA

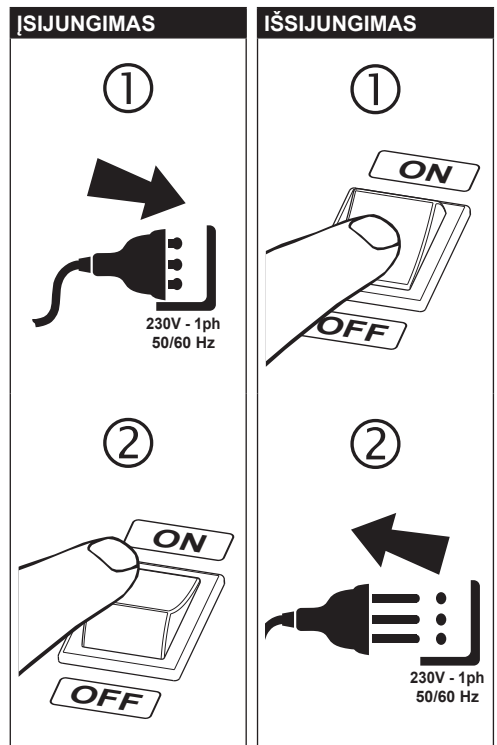

A ĮKROVA/PALAIKYMAS

PULSE-TRONIC TECHNOLOGIJA

Pulseⁿⁿⁿ
Tronic



1 PULSE-TRONIC PASIRINKIMAS

FUNCTION



EKRANAS

Pulseⁿⁿⁿ
Tronic

2 AKUMULATORIAUS TIPO PASIRINKIMAS

FUNCTION



EKRANAS



AUTOMATINĖ

AUTOMATINĖ
ŽIEMA T<0°C

RANKINIS

3 SROVĖS PASIRINKIMAS

MODE



EKRANAS



AUTOMATINĖ

GREITASIS
ĮKROVIMAS

RANKINIS

3A (●) Ah NUSTATYMAS - PAVYZDYS

MODE

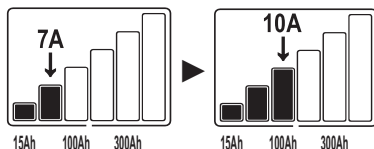

EKRANAS

85 Ah

VOLT



80Ah
75Ah
70Ah

FUNCTION



100Ah
95Ah
90Ah

4 ĮTAMPOS PASIRINKIMAS

VOLT



EKRANAS

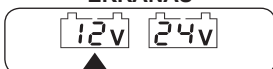

Info
Alarm

5 GNYBTŲ PRIJUNGIMAS

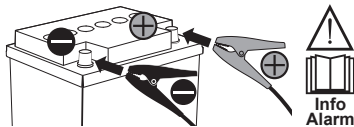

PULSE-TRONIC GRAFIKAS

6 GRAFICO PULSE-TRONIC

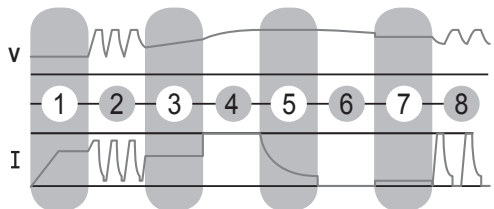

- 1 Akumulatoriaus testavimas
- 2 Sulfatais apsinėšusių/visiškai išsikrovusių akumuliatorių atkūrimas
- 3 Vientisumo patikrinimas
- 4 Įkrova iki 80%
- 5 Įkrova iki 100%
- 6 Įkrovos palaikymo stebėjimas
- 7 Įkrovos palaikymas
- 8 Įkrovos impulsais atstatymas

7 ĮKROVOS PABAIGA - PAVYZDYS



B TESTAS

ĮKROVOS BŪSENA



1 TESTO PASIRINKIMAS

FUNCTION



EKRANAS

TEST



2 AKUMULIATORIAUS TIPO PASIRINKIMAS

FUNCTION



EKRANAS

WET EFB GEL AGM + Li



3 GNYBTŲ PRIJUNGIMAS

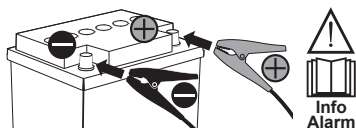

4 ĮTAMPOS PASIRINKIMAS

VOLT



EKRANAS

12V 24V



5 TESTO PABAIGA - PAVYZDYS

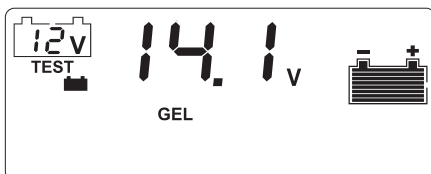

EKRANO SUTARTINIAI ŽENKLAI



reikia įkrauti



reikia įkrauti



įkrautas

B TESTAS

AKUMULIATORIAUS PALEIDIMO GALIA



1 TESTO PASIRINKIMAS

FUNCTION



EKRANAS

TEST

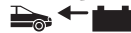

2 GNYBTŲ PRIJUNGIMAS

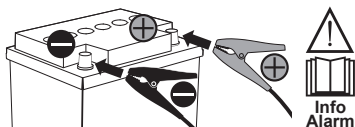

3 GNYBTŲ PRIJUNGIMAS

VOLT



EKRANAS

12V 24V



EKRANAS

Go

4 TRANSPORTO PRIEMONĖS PALEIDIMAS



5 TESTO PABAIGA - PAVYZDYS



EKRANO SUTARTINIAI ŽENKLAI

OK

veikiantis

SUF

pakankamas

bAd

nepakankamas

B TESTAS

GENERATORIUS



1 TESTO PASIRINKIMAS

FUNCTION



EKRANAS



2 GNYBTŲ PRIJUNGIMAS

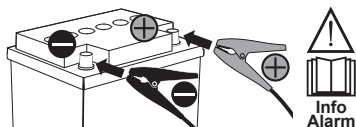

3 ĮTAMPOS PASIRINKIMAS

VOLT



EKRANAS

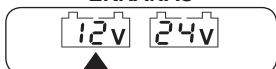

EKRANAS



4 TRANSPORTO PRIEMONĖS PALEIDIMAS



5 TESTO PABAIGA - PAVYZDYS



EKRANO SUTARTINIAI ŽENKLAI

OK	SUF	bAd
veikiantis	pakankamas	nepakankamas

C TECHINĖ PRIEŽIŪRA

DESULFATAVIMAS

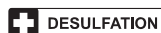

1 IŠPLĖSTINIO MENIU PASIRINKIMAS

FUNCTION



MENIU

IŠPLĖSTINĖS PROGRAMOS

2 FUNKCIJOS PASIRINKIMAS

FUNCTION



EKRANAS

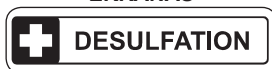

3 ĮTAMPOS PASIRINKIMAS

VOLT



EKRANAS

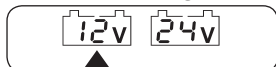

4 GNYBTŲ PRIJUNGIMAS

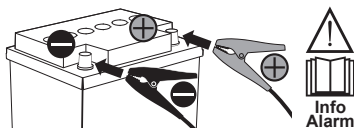

PALEIDIMAS PO 5"

5 PROCESO PABAIGA - PAVYZDYS



6 IŠĖJIMAS IŠ IŠPLĖSTINIO MENIU

FUNCTION



3"

BEEEP

C TECHNINĖ PRIEŽIŪRA

IŠLYGINIMAS

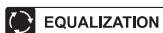

1 IŠPLĖSTINIO MENIU PASIRINKIMAS

FUNCTION



4 GNYBTŲ PRIJUNGIMAS

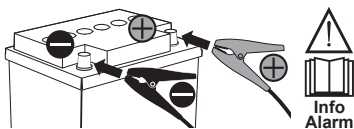

PALEIDIMAS PO 5"

2 FUNKCIJOS PASIRINKIMAS

FUNCTION



EKRANAS



5 PROCESO PABAIGA - PAVYZDYS

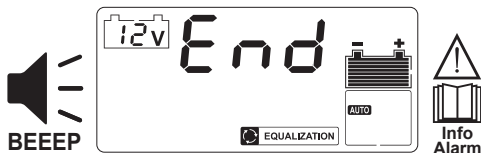

3 ĮTAMPOS PASIRINKIMAS

VOLT



EKRANAS

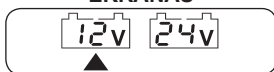

6 IŠĖJIMAS IŠ IŠPLĖSTINIO MENIU

FUNCTION



3A ĮTAMPOS PRITAIKYMAS - PAVYZDYS



PATIKRINTI AKUMULIATORIAUS TIPA (WET, EFB, GEL, AGM +, Li) IR MAKS. LEISTINĄ ĮTAMPĄ.

VOLT



FUNCTION

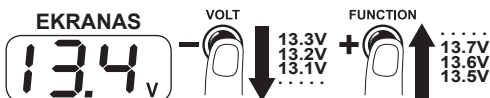

KLAVIATŪROS UŽBLOKAVIMAS / ATBLOKAVIMAS

UŽBLOKAVIMAS

VOLT



MODE



EKRANAS



ATBLOKAVIMAS

VOLT



MODE



EKRANAS



D MAITINIMAS

MAITINIMO BLOKAS

SUPPLY

AKUMULIATORIAUS
PAKEITIMAS

1 IŠPLĖSTINIO MENIU PASIRINKIMAS

FUNCTION



3"



BEEEP



2 FUNKCIJOS PASIRINKIMAS

FUNCTION



EKRANAS



ĮTAMPA TARP GNYBTŲ (MAX 27V).

3 ĮTAMPOS PASIRINKIMAS

VOLT



EKRANAS

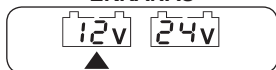

Info Alarm

3A ĮTAMPOS PRITAIKYMAS - PAVYZDYS



PATIKRINTI TRANSPORTO PRIEMONĖS GAMINTOJO SPECIFIKACIJOSE MAKS. LEISTINĄ ĮTAMPĄ.

VOLT



3"

FUNCTION



BEEEP

EKRANAS



VOLT



13.3V
13.2V
13.1V

FUNCTION



13.7V
13.6V
13.5V

3B SROVĖS PRITAIKYMAS - PAVYZDYS

MODE

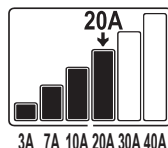
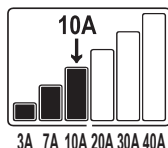

4 EKRANAS- PAVYZDYS



SUPPLY

5 GNYBTŲ PRIJUNGIMAS PRIE TRANSPORTO PRIEMONĖS AKUMULIATORIAUS LAIDŲ

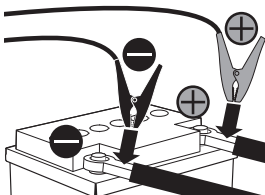

6



AKUMULIATORIAUS IŠĖIMAS



AKUMULIATORIAUS PAKEITIMAS

7 IŠĖJIMAS IŠ IŠPLĖSTINIO MENIU

FUNCTION



3"



BEEEP

KLAVIATŪROS UŽBLOKAVIMAS / ATBLOKAVIMAS

UŽBLOKAVIMAS

VOLT



MODE



EKRANAS

Lok on

ATBLOKAVIMAS

VOLT



MODE



EKRANAS

Lok off

E PALEIDIMAS

START

12V

1 FUNKCIJOS PASIRINKIMAS

MODE



EKRANAS

START

2 ĮTAMPOS PASIRINKIMAS

VOLT



EKRANAS

12V 24V



3 GNYBTŲ PRIJUNGIMAS PRIE AKUMULIATORIAUS

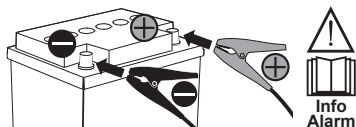

EKRANAS

00

4 TRANSPORTO PRIEMONĖS PALEIDIMAS



5 TIMER 30" IKI SEKANČIO PALEIDIMO

EKRANAS

30
29
28

6 IŠĖJIMAS IŠ FUNKCIJOS

MODE



PERSPĖJIMO SIGNALŲ INFORMACIJA



Info Alarm

RL 1

TRUMPAS SUJUNGIMAS

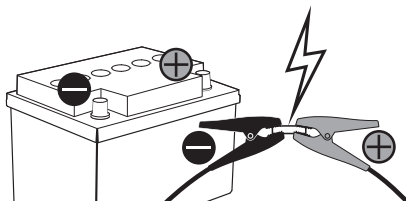

POLIŠKUMO SUKEITIMAS

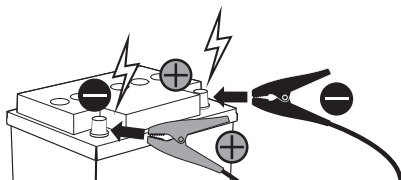

RL 2

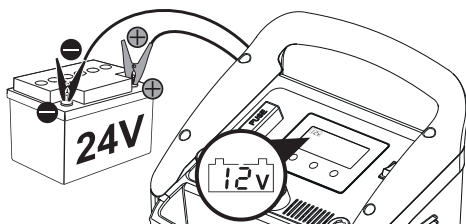

RL 4

RL 5

RL 6

RL 7

RL 8

Pulse *Tronic*



RL 9

TRUMPAS SUJUNGIMAS

EQUALIZATION

DIAGNOSTIC

SUPPLY

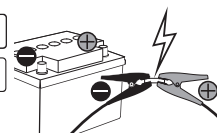

SIGNALIZAVIMAS PERKAITIMAS Automatinis darbo atsinaujinimas

AVARINIS SIGNALAS SILUMINIS

000



00



LCD KUVAR (lk. 2)

1. Seadistatud polaarsusega aku.
2. Põhikuvar: aku mõõdetud pingevool, valiku Ah, valitud pingeväärtus programmidele Supply / Equalization, kasutajaliidese sõnumid operaatori suunas, hoiatuskoodid.
3. Pöördpolaarsuse, lühise, kulunud või riknenud aku hoiatus.
4. Seadistatud vool ja pingev. Hoiatuskoodid "AL1 - AL9".
5. Aku laetuse tase.
6. Laadimisvoolu valik PULSE-TRONIC: AUTO, BOOST, Personaliseeritud (Ah seadistamine).
7. Funktsioneerimine madalatel temperatuuridel.
9. Režiim EQUALIZATION.
10. Režiim DESULFATION.
11. Aku tüübi valik:
WET: pliiakud, vedel elektrolüüt;
GEL: suletud pliiakud, tahke elektrolüüt;
AGM: suletud pliiakud, elektrolüüt imaval materilil;
+ (CA): plii-kaltsium akud.
12. Režiim SUPPLY.
14. Laadimisfaasid PULSE-TRONIC.
15. Režiim START.
16. Automaatlaadimisrežiim.
17. Laadimine PULSE-TRONIC.
18. Laadimisahela funktsioneerimistest (vahelduvvoolu generaator).
19. Aku käivitussuutlikuse test - CCA.
20. Aku laetuse test.
21. VOLT - Seadistusnupp:
- aku pingev 12/24V;
- kasutuspinge seadistamine/Ah.
22. FUNCTION - Seadistusnupp:
- LAENG PULSE -TRONIC (AUTO, AUTO *, WET, EFB, GEL, AGM +, Li);
- TEST (aku seisund, sõiduki voolugeneraator, aku käivitussuutlikus);
- Lisaprogrammid (DESULFATION, EQUALIZATION, SUPPLY);
- kasutuspinge seadistamine/Ah.
23. MODE - Seadistusnupp:
- väljundvool (AUTO, BOOST, Režiim START.

FUNKTSIOONID

- A. LAE PULSE TRONIC
- B. TEST
- LAETUSE TEST
- AKU KÄIVITUSSUUTLIKUSE TEST (CCA)
- VAHELDUVVoolu GENERAATORI TEST
- C. AKUDE HOOLDUS
- ÜHTLUSTAMINE
- DESULFEERIMINE
- D. TOITEALLIKAS
- TOIDE
- E. KÄIVITAMINE - START

HÄIREINFO

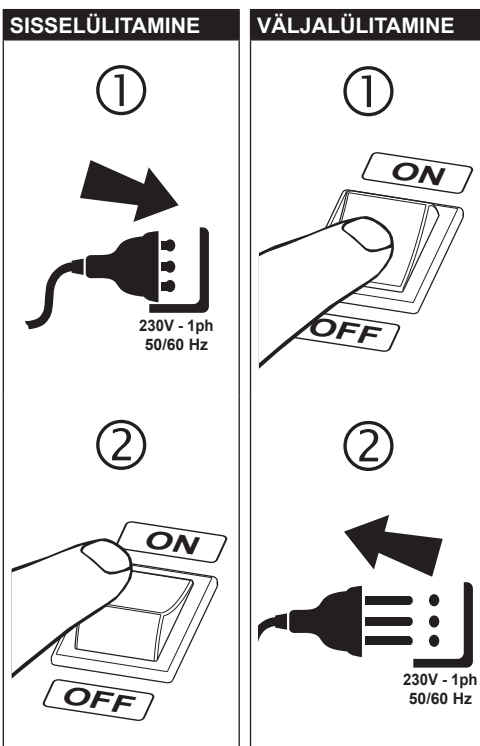

A LAADIMINE/HOIDMINE

PULSE-TRONIC TEHNOLOGIA *Pulse^{TRONIC}*



1 PULSE-TRONIC VALIMINE

FUNCTION



KUVAR

Pulse^{TRONIC}

2 AKU TÜÜBI VALIMINE

KUVAR



FUNCTION



AUTOMAATNE

AUTOMAATNE
TALV T<0°C

KÄSITSI

3 VOOLU VALIMINE

KUVAR



MODE



AUTOMAATNE

KIIRLAADIMINE

KÄSITSI

3A (●) SEADISTAMINE Ah - NÄIDE

MODE

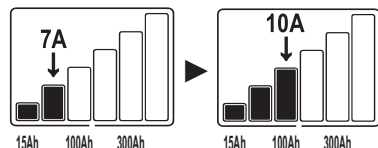

KUVAR

85 Ah

VOLT



80Ah
75Ah
70Ah

FUNCTION



100Ah
95Ah
90Ah

4 PINGE VALIMINE

VOLT



KUVAR

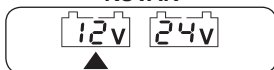

5 KLEMMIDE ÜHENDAMINE

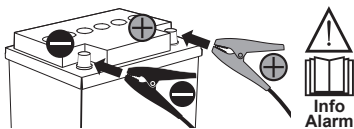

KÄIVITUS PÄRAST 5"

6 GRAAFILINE PULSE-TRONIC

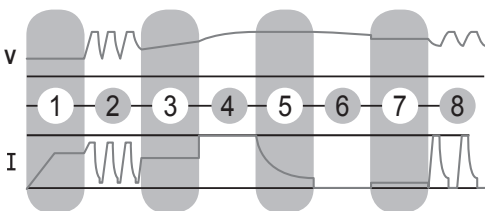

- 1 Aku test
- 2 Sulfureeritud/tühjade akude taastamine
- 3 Terviklikkuse kontroll
- 4 Laadimine kuni 80%
- 5 Laadimine kuni 100%
- 6 Laengu hoimise jälgimine
- 7 Laengu hoidmine
- 8 Impulsslaadimise taastamine

7 LAADIMISE LÕPP - NÄIDE



B TEST

LAETUSE ASTE



1 TESTI VALIMINE

FUNCTION



KUVAR
TEST



2 AKU TÜÜBI VALIMINE

FUNCTION



KUVAR
WET EFB GEL AGM + Li



3 KLEMMIDE ÜHENDAMINE

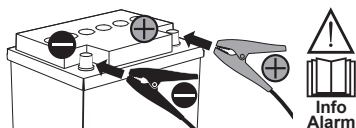

4 PINGE VALIMINE

VOLT



KUVAR

12V 24V



5 TESTI LÖPP - NÄIDE



GEL

KUVARI LEGEND



laadida



laadida



laetud

B TEST

AKU KÄIVITUSSUUTLIKUS



1 TESTI VALIMINE

FUNCTION



KUVAR
TEST



2 KLEMMIDE ÜHENDAMINE

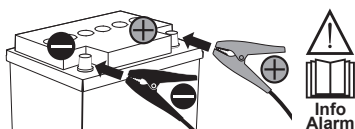

3 PINGE VALIMINE

VOLT



KUVAR

12V 24V



KUVAR

Go

4 SÕIDUKI KÄIVITAMINE



5 TESTI LÖPP - NÄIDE



KUVARI LEGEND

OK

töötav

SUF

piisav

bAd

ebapiisav

B TEST

VAHELDUVVOOLU GENERAATOR



1 TESTI VALIMINE

FUNCTION



KUVAR



2 KLEMMIDE ÜHENDAMINE

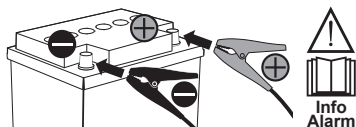

3 PINGE VALIMINE

VOLT



KUVAR

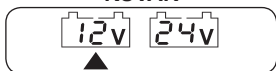

KUVAR



4 SÕIDUKI KÄIVITAMINE



5 TESTI LÕPP - NÄIDE



KUVARI LEGEND

OK	SUF	bAd
töötav	piisav	ebapiisav

C HOOLDUS

DESULFEERIMINE

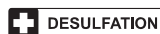

1 LISAMENÜÜ VALIMINE

FUNCTION



MENÜÜ

LISAPROGRAMMID

2 FUNKTSIOONI VALIMINE

FUNCTION



KUVAR

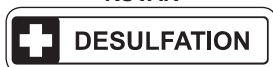

3 PINGE VALIMINE

VOLT



KUVAR

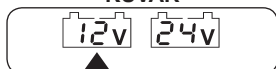

4 KLEMMIDE ÜHENDAMINE

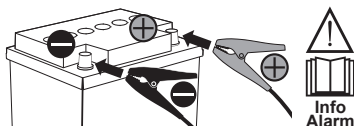

KÄIVITAMINE PÄRAST 5"

5 PROTSESSI LÕPP - NÄIDE



6 LISAMENÜÜST VÄLJUMINE

FUNCTION



3"

C HOOLDUS

ÜHTLUSTAMINE

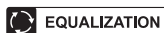

1 LISAMENÜÜ VALIMINE

FUNCTION



2 FUNKTSIOONI VALIMINE

FUNCTION



3 PINGE VALIMINE

VOLT

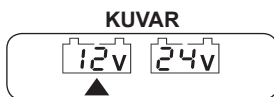

3A PINGE PERSONALISEERIMINE - NÄIDE



KONTROLLI AKU TÜÜPI (WET, EFB, GEL, AGM +, Li) JA LUBATUD MAKSIMUM PINGET.

VOLT



FUNCTION

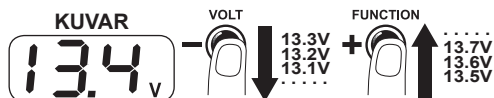

4 KLEMMIDE ÜHENDAMINE

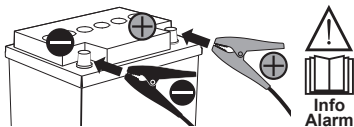

KÄIVITAMINE PÄRAST 5"

5 PROTSESSI LÕPP - NÄIDE

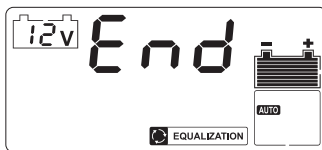

6 LISAMENÜÜST VÄLJUMINE

FUNCTION



KLAVIATUURI BLOKEERIMINE / VABASTAMINE

BLOKERIMINE

VOLT



MODE



KUVAR

Lok on

VABASTAMINE

VOLT



MODE



KUVAR

Lok off

D TOIDE

TOITEALLIKAS

SUPPLY

AKUVAHETUS

1 LISAMENÜÜ VALIMINE

FUNCTION



2 FUNKTSIOONI VALIMINE

FUNCTION



KUVAR



KLEMMIDE VAHELINE PINGE (MAX 27V).

3 PINGE VALIMINE

VOLT



KUVAR



3A PINGE PERSONALISEERIMINE - NÄIDE



KONTROLLIDA SÕIDUKI TOOTJA SPETSIFIKATSIOONIDEST LUBATUD MAKSIMUMPINGET.

VOLT



FUNCTION



3"

BEEP

KUVAR



VOLT



FUNCTION



13.3V
13.2V
13.1V
.....

13.7V
13.6V
13.5V
.....

3B VOOLU PERSONALISEERIMINE - NÄIDE

MODE

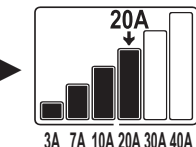
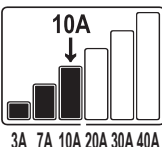

4 KUVAR - NÄIDE



5 KLEMMIDE ÜHENDAMINE SÕIDUKI AKU KAABLITEGA

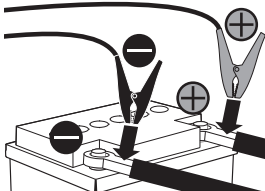

6



7 LISAMENÜÜST VÄLJUMINE

FUNCTION



3"

BEEP

KLAVIATUURI BLOKEERIMINE / VABASTAMINE

BLOKERIMINE

VOLT



MODE



KUVAR



VABASTAMINE

VOLT



MODE



KUVAR



E KÄIVITAMINE

START

12V

1 FUNKTSIOONI VALIMINE

MODE



KUVAR

START

2 PINGE VALIMINE

VOLT



KUVAR

12V 24V



Info Alarm

3 KLEMMIDE ÜHENDAMINE AKUGA

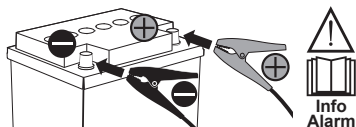

Info Alarm

KUVAR

00

4 SÕIDUKI KÄIVITAMINE



5 TAIMER 30" PÄRAST JÄRGMIST KÄIVITAMIST

KUVAR

30
29
28

6 FUNKTSIOONIST VÄLJUMINE

MODE



HÄIREINFO



Info Alarm

AL 1

VOOLULÜHIS

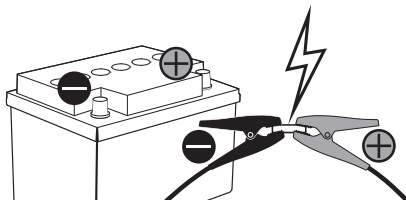

PÖÖRPOLAARSUS

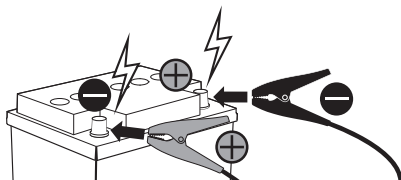

AL 2

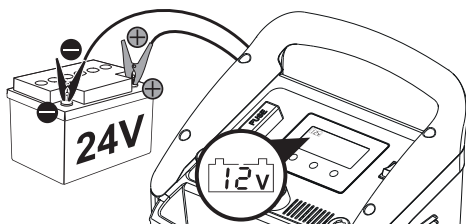

AL 4

AL 5

AL 6

AL 7

AL 8

Pulse *mm*
Tronic



AL 9

VOOLULÜHIS

EQUALIZATION

DIAGNOSTIC

SUPPLY

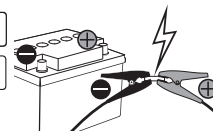

LÜHIS
ÜLEKUUMENEMINE
Automaatne
taaskäivitamine

HÄIRE
TERMININE

000



00



LCD DISPLEJS (2. lpp.)

1. Iestatītais akumulatora spriegums.
2. Galvenais displejs: izmērītais akumulatora spriegums/strāva, atlasītais Ah, sprieguma vērtība, kas atlasīta programmām Supply / Equalization, operatora saskarnes ziņojumi, trauksmes signālu kodi.
3. Trauksmes signāls polaritātes neievērošanas, īssavienojuma, nodiluša vai bojāta akumulatora gadījumā.
4. Strāva un spriegums ir iestatīts.
Trauksmes signālu kodi "AL1 - AL9".
5. Akumulatora uzlādes līmenis.
6. Uzlādes strāvas izvēle PULSE-TRONIC: AUTO, BOOST, Pielāgota (Ah iestatīšana).
7. Darbība zemā temperatūrā.
9. Režīms EQUALIZATION.
10. Režīms DESULFATION.
11. Akumulatora tipa izvēle:
WET: svina akumulatori, šķidrns elektrolīts;
GEL: svina akumulatori, hermētiski, ciets elektrolīts;
AGM: svina akumulatori, hermētiski, elektrolīts absorbentā;
+ (CA): svina-kalcija akumulatori.
12. Režīms SUPPLY.
14. Uzlādes fāzes PULSE-TRONIC.
15. Režīms START.
16. Automātiskās uzlādes režīms.
17. Uzlādēšana režīmā PULSE-TRONIC.
18. Uzlādes ķēdes darbības pārbaude (ģenerators).
19. Akumulatora palaišanas spējas pārbaude - CCA.
20. Akumulatora uzlādēšanas stāvokļa pārbaude.
21. VOLT - iestatīšanas poga:
- akumulatora spriegums 12/24V;
- sprieguma/Ah regulēšana.
22. FUNCTION - iestatīšanas poga:
- UZLĀDE PULSE -TRONIC (AUTO, AUTO *
WET, EFB, GEL, AGM +, Li);
- TEST (akumulatora stāvoklis, transportlīdzekļa ģenerators, akumulatora palaišanas spēja);
- Paplašinātas programmas (DESULFATION, EQUALIZATION, SUPPLY);
- sprieguma/Ah regulēšana.
23. MODE - iestatīšanas poga:
- izejas strāva (AUTO, BOOST, pielāgota);
- Režīms START.

FUNKCIJAS

- A. UZLĀDE PULSE TRONIC
- B. PĀRBAUDE
 - UZLĀDES STĀVOKĻA PĀRBAUDE
 - AKUMULATORA PALAIŠANAS SPĒJAS PĀRBAUDE (CCA)
 - ĢENERATORA PĀRBAUDE
- C. AKUMULATORU APKOPE
 - IZLĪDZINĀŠANA
 - DESULFATĪZĀCIJA
- D. BAROŠANAS
 - BAROŠANA
- E. IEDARBINĀŠANA - START

INFORMĀCIJA PAR TRAUKSMES SIGNĀLIEM

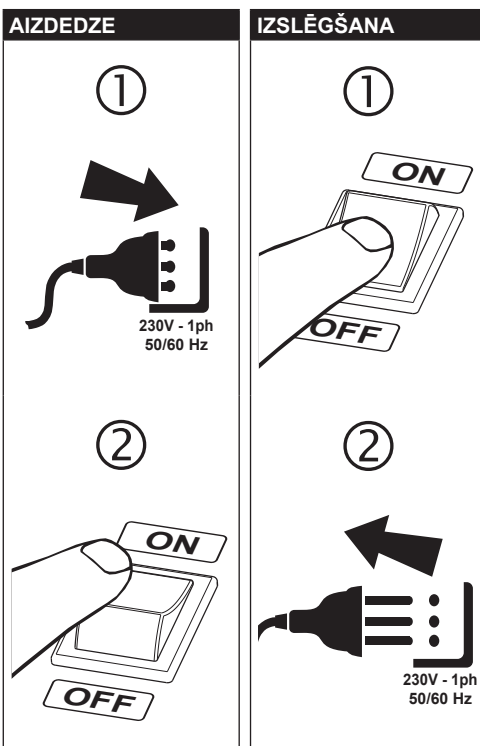

A UZLĀDĒŠANA/UZTURĒŠANA

TEHNOĻĪJA PULSE-TRONIC

Pulseⁿⁿⁿ
Tronic



1 PULSE-TRONIC IZVĒLE

FUNCTION



DISPLEJS

Pulseⁿⁿⁿ
Tronic

2 AKUMULATORA TIPA IZVĒLE

FUNCTION



DISPLEJS

AUTO

AUTO ❄️

WET EFB GEL AGM + Li



AUTOMĀTISKS

AUTOMĀTISKS
ZIEMA T<0°C

MANUĀLS

3 STRĀVAS IZVĒLE

MODE



DISPLEJS

AUTO

AUTO BOOST

Ah (●)



AUTOMĀTISKS

ĀTRĀ UZLĀDE

MANUĀLS

3A (●) Ah IESTATĪŠANA - PIEMĒRS

MODE

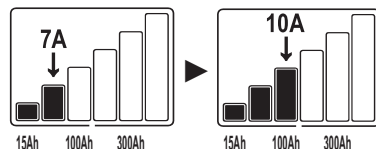

DISPLEJS
85 Ah

VOLT



80Ah
75Ah
70Ah

FUNCTION



100Ah
95Ah
90Ah

4 SPRIEGUMA IZVĒLE

VOLT



DISPLEJS

12v 24v



5 SPAIŅU PIEVIENOŠANA

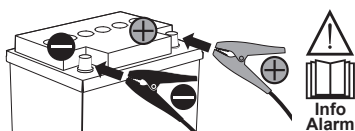

PALAIŠANA PĒC 5 SEKUNDĒM

6 PULSE-TRONIC GRAFIKS

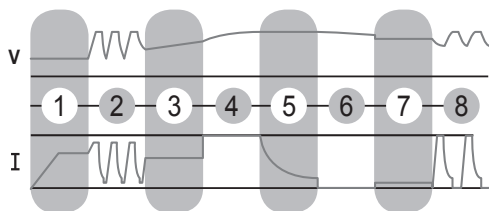

- 1 Akumulatora pārbaude
- 2 Sulfatācijai pakļautu/dzīli izlādējušos akumulatoru atjaunošana
- 3 Integritātes pārbaude
- 4 Uzlādēšana līdz 80%
- 5 Uzlādēšana līdz 100%
- 6 Lādiņa uzturēšanas kontrole
- 7 Uzlādes uzturēšana
- 8 Impulsi uzlādes atjaunošana

7 UZLĀDES PABEIGŠANA - PIEMĒRS



B PĀRBAUDE

UZLĀDES STĀVOKLIS



1 PĀRBAUDES IZVĒLE

FUNCTION



DISPLEJS
TEST



2 AKUMULATORA TIPA IZVĒLE

FUNCTION



DISPLEJS
WET EFB GEL AGM + Li



3 SPAIŅU PIEVIENOŠANA

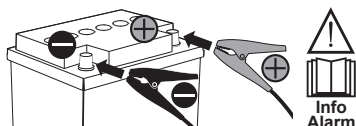

4 SPRIEGUMA IZVĒLE

VOLT



DISPLEJS

12V 24V



5 PĀRBAUDES PABEIGŠANA - PIEMĒRS



APZĪMĒJUMI UZ DISPLEJA



B PĀRBAUDE

AKUMULATORA PALAIDES SPĒJA



1 PĀRBAUDES IZVĒLE

FUNCTION



DISPLEJS
TEST



2 SPAIŅU PIEVIENOŠANA

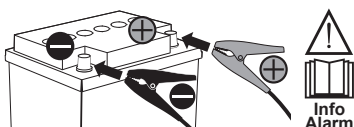

3 SPRIEGUMA IZVĒLE

VOLT



DISPLEJS

12V 24V



DISPLEJS

Go

4 TRANSPORTLĪDZEKĻA IEDARBINĀŠANA



5 PĀRBAUDES PABEIGŠANA - PIEMĒRS



APZĪMĒJUMI UZ DISPLEJA

OK

darbojas

SUF

pietiekošs

bAd

nepietiekošs

B PĀRBAUDE

ĢENERATORS



1 PĀRBAUDES IZVĒLE

FUNCTION



DISPLEJS



2 SPAIŅU PIEVIENOŠANA

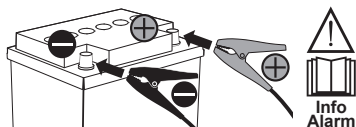

3 SPRIEGUMA IZVĒLE

VOLT



DISPLEJS

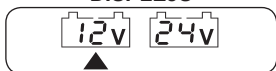

DISPLEJS



4 TRANSPORTLĪDZEKĻA IEDARBINĀŠANA



5 PĀRBAUDES PABEIGŠANA - PIEMĒRS



APZĪMĒJUMI UZ DISPLEJA

OK
darbojas

SUF
pietiekošs

bAd
nepietiekošs

C TEHNISKĀ APKOPE

DESULFATIZĀCIJA

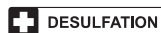

1 PAPLAŠINĀTAS IZVĒLNES ATĻASE

FUNCTION



IZVĒLNE

PAPLAŠINĀTAS
PROGRAMMAS

2 FUNKCIJAS ATĻASE

FUNCTION



DISPLEJS

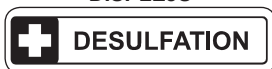

3 AKUMULATORA SPRIEGUMA IZVĒLE

VOLT



DISPLEJS

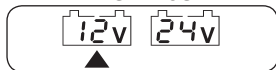

4 SPAIŅU PIEVIENOŠANA

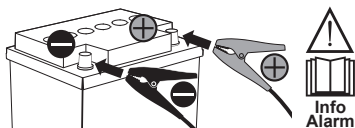

PALAIŠANA PĒC 5 SEKUNDĒM

5 PROCESA PABEIGŠANA - PIEMĒRS



6 IZEJA NO PAPLAŠINĀTAS IZVĒLNES

FUNCTION



3"

BEEEP

C TEHNISKĀ APKOPE

IZLĪDZINĀŠANA

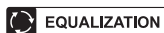

1 PAPLAŠINĀTAS IZVĒLNES ATLAŠE

FUNCTION



BEEEP



2 FUNKCIJAS ATLAŠE

FUNCTION



DISPLEJS

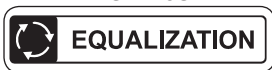

3 AKUMULATORA SPRIEGUMA IZVĒLE

VOLT



DISPLEJS

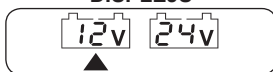

Info Alarm

3A SPRIEGUMA IESTATĪŠANA - PIEMĒRS



PĀRBAUDIET AKUMULATORA TIPU (WET, EFB, GEL, AGM +, Li) UN MAKS. PIEĻAUJAMO SPRIEGUMU.

VOLT



FUNCTION



BEEEP

DISPLEJS



VOLT



13.3V
13.2V
13.1V
.....

FUNCTION



13.7V
13.6V
13.5V

4 SPAIŅU PIEVIEŅOŠANA

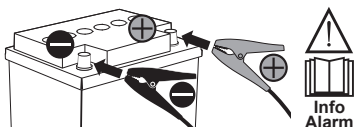

Info Alarm

PALAIŠANA PĒC 5 SEKUNDĒM

5 PROCESA PABEIGŠANA - PIEMĒRS



BEEEP

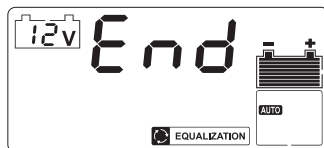

EQUALIZATION



Info Alarm

6 IZEJA NO PAPLAŠINĀTAS IZVĒLNES

FUNCTION



3"



BEEEP

TASTATŪRAS BLOKĒŠANA/ATBLOKĒŠANA

BLOKĒŠANA

VOLT



MODE



DISPLEJS



ATBLOKĒŠANA

VOLT



MODE



DISPLEJS



D BAROŠANA

BAROTĀJS

SUPPLY

AKUMULATORA
MAIŅA

1 PAPLAŠINĀTAS IZVĒLNES ATLASE

FUNCTION



3"



BEEEP

IZVĒLNE

PAPLAŠINĀTAS
PROGRAMMAS

2 FUNKCIJAS ATLASE

FUNCTION



DISPLEJS

SUPPLY



SPRIEGUMA ESAMĪBA STARP
SPAILĒM (MAX 27V).

3 AKUMULATORA IZVĒLE SPRIEGUMA

VOLT



DISPLEJS

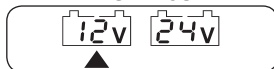

Info
Alarm

3A SPRIEGUMA IESTATĪŠANA - PIEMĒRS



INFORMĀCIJA PAR MAKS. PIELAUJAMO
SPRIEGUMU IR ATRODAMA RAŽOTĀJA
SPECIFIKĀCIJĀS.

VOLT



FUNCTION



BEEEP

DISPLEJS



VOLT



13.3V
13.2V
13.1V
.....

FUNCTION



13.7V
13.6V
13.5V
.....

3B STRĀVAS IESTATĪŠANA - PIEMĒRS

MODE

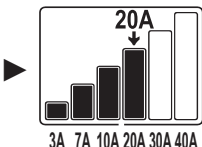
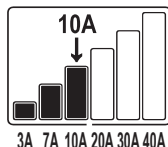

4 DISPLEJS - PIEMĒRS



5 SPAIŅU PIEVIENOŠANA TRANSPORTLĪDZEKĻA AKUMULATORAM

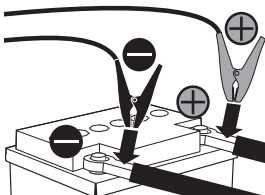

6



AKUMULATORA
IZŅEMŠANA



AKUMULATORA
MAIŅA

7 IZEJA NO PAPLAŠINĀTAS IZVĒLNES

FUNCTION



3"



BEEEP

TASTATŪRAS BLOKĒŠANA/ATBLOKĒŠANA

BLOKĒŠANA

VOLT



MODE



DISPLEJS

Lok on

ATBLOKĒŠANA

VOLT



MODE



DISPLEJS

Lok off

E IEDARBINĀŠANA

START

12V

1 FUNKCIJAS ATLASE

MODE



DISPLEJS

START

2 SPRIEGUMA IZVĒLE

VOLT



DISPLEJS

12V 24V



3 SPAIŅU PIEVIENOŠANA PIE AKUMULATORA

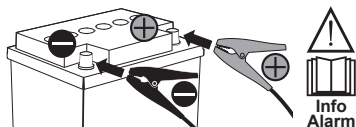

DISPLEJS

00

4 TRANSPORTLĪDZEKĻA IEDARBINĀŠANA



5 30 SEKUNŽU TAIMERIS NĀKAMAJAI IEDARBINĀŠANAI

DISPLEJS

30
29
28

6 IZEJA NO FUNKCIJAS

MODE



INFORMĀCIJA PAR TRAUKSME SIGNĀLIEM



Info Alarm

AL 1

ĪSSAVIENOJUMS

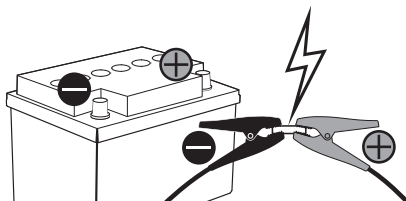

POLARITĀTES NIEVĒROŠANA

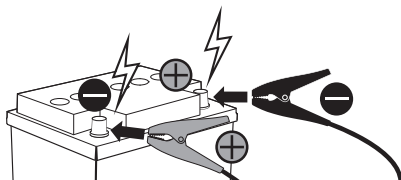

AL 2

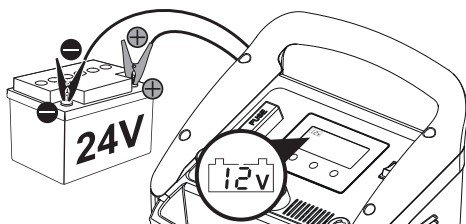

AL 4

AL 5

AL 6

AL 7

AL 8

Pulse *Tronic*



AL 9

ĪSSAVIENOJUMS

EQUALIZATION

DIAGNOSTIC

SUPPLY

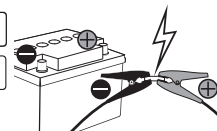

SIGNALIZĀCIJA PĀRKARŠANA
Automātiska darbības atjaunošana

TRAUKSME TERMISKĀ AIZSARDZĪBA

000



00



LCD ДИСПЛЕЙ (стр. 2)

1. Зададено напрежение на акумулатора.
2. Главен дисплей: измерено напрежение-ток на акумулатора, Ah за избор, стойност на избраното напрежение за програми Supply / Equalization, интерфейсни съобщения за оператора, кодове на алармите.
3. Аларма за обръщане на полярността, късо съединение, изтощен или повреден акумулатор.
4. Зададен ток и напрежение.
Кодове на аларми "AL1 - AL9".
5. Степен на зареждане на акумулатора.
6. Избор на ток за зареждане PULSE-TRONIC: AUTO, BOOST, персонализиран (задаване на Ah).
7. Функциониране при ниски температури.
9. Режим EQUALIZATION.
10. Режим DESULFATION.
11. Избор на типа акумулатор:
WET: оловни акумулатори с течен електролит;
GEL: оловни акумулатори, запечатани с твърд електролит;
AGM: оловни акумулатори, запечатани, електролит с абсорбиращ материал;
+ (CA): оловно-калциеви акумулатори.
12. Режим SUPPLY.
14. Фази на зареждане PULSE-TRONIC.
15. Режим START.
16. Режим на автоматично зареждане.
17. Зареждане в PULSE-TRONIC.
18. Тест за функционирането на системата за зареждане (алтернатор).
19. Тест на капацитета за пускане на акумулатора - CCA.
20. Тест за степента на зареждане на акумулатора.
21. VOLT - Бутон за задаване:
- напрежение на акумулатора 12/24V;
- регулиране на волтаж/Ah.
22. FUNCTION - Бутон за задаване на:
- ЗАРЕЖДАНЕ PULSE -TRONIC (AUTO, AUTO *, WET, EFB, GEL, AGM +, Li);
- TEST (състояние на акумулатор, алтернатор на автомобила, капацитет за пускане на акумулатора);
- Усъвършенствани програми (DESULFATION, EQUALIZATION, SUPPLY);
- регулиране на волтаж/Ah.
23. MODE - Бутон за задаване на:
- изходен ток (AUTO, BOOST, персонализиран);
- Режим START.

ФУНКЦИИ

- A. ЗАРЕЖДАНЕ PULSE TRONIC
- B. ТЕСТ
 - ТЕСТ ЗА СТЕПЕНТА НА ЗАРЕЖДАНЕ
 - ТЕСТ НА КАПАЦИТЕТА ЗА ПУСКАНЕ НА АКУМУЛАТОРА (CCA)
 - ТЕСТ НА АЛТЕРНАТОРА
- C. ПОДДРЪЖКА НА АКУМУЛАТОРА
 - СТАБИЛИЗИРАНЕ
 - ДЕСУЛФАТИЗАЦИЯ НА АКУМУЛАТОРА
- D. ЗАХРАНВАНЕ
 - ЗАХРАНВАНЕ
- E. СТАРТИРАНЕ - START

ИНФОРМАЦИЯ АЛАРМИ

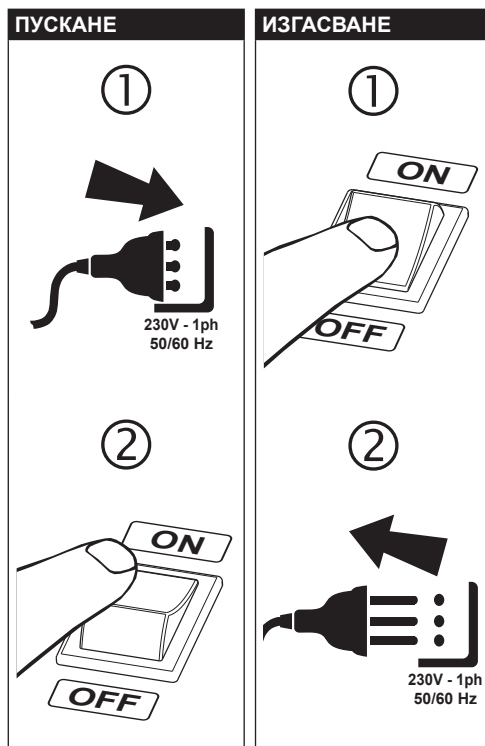

A ЗАРЕЖДАНЕ/ПОДДРЪЖКА

ТЕХНОЛОГИЯ PULSE-TRONIC

Pulse lll
Tronic



1 ИЗБОР НА PULSE-TRONIC FUNCTION



2 ИЗБОР НА ТИПА АКУМУЛАТОР



3 ИЗБОР НА ТОКА



3A (●) ЗАДАВАНЕ НА Ah - ПРИМЕР

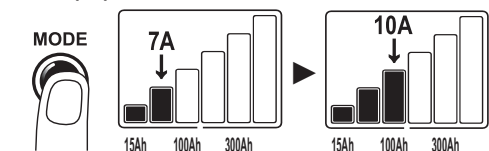

4 ИЗБОР НА НАПРЕЖЕНИЕ



5 СВЪРЗВАНЕ НА ЩИПКИТЕ

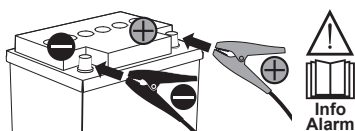

ПУСКАНЕ СЛЕД 5"

6 ГРАФИКА PULSE-TRONIC

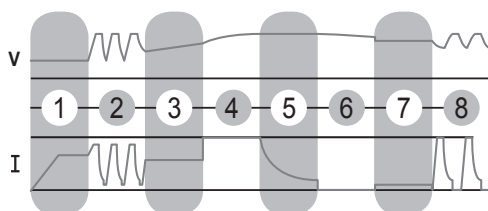

- 1 Тест на акумулатора
- 2 Възстановяване на сулфатизирани/силно изтощени акумулатори
- 3 Проверка на целостта
- 4 Зареждане на 80%
- 5 Зареждане на 100%
- 6 Мониторинг на поддържането на зареждане
- 7 Поддържане на зареждането
- 8 Възстановяване на зареждането с импулси

7 КРАЙ НА ЗАРЕЖДАНЕТО - ПРИМЕР



B TEST

СТЕПЕН НА ЗАРЕЖДАНЕ

1 ИЗБОР НА ТЕСТ

FUNCTION



ДИСПЛЕЙ
TEST 



2 ИЗБОР НА ТИПА АКУМУЛАТОР

FUNCTION



ДИСПЛЕЙ
WET EFB GEL AGM + Li
▲



3 СВЪРЗВАНЕ НА ЩИПКИТЕ

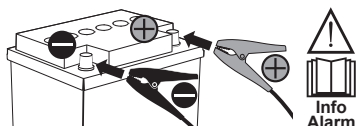

4 ИЗБОР НА НАПРЕЖЕНИЕ

VOLT



5 КРАЙ НА ТЕСТА - ПРИМЕР



ЛЕГЕНДА НА ДИСПЛЕЯ



B TEST

КАПАЦИТЕТ ЗА ПУСКАНЕ НА АКУМУЛАТОРА

1 ИЗБОР НА ТЕСТ

FUNCTION



ДИСПЛЕЙ
TEST 



2 СВЪРЗВАНЕ НА ЩИПКИТЕ

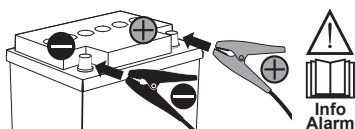

3 ИЗБОР НА НАПРЕЖЕНИЕ

VOLT



ДИСПЛЕЙ



4 ПУСКАНЕ НА АВТОМОБИЛА



5 КРАЙ НА ТЕСТА - ПРИМЕР



ЛЕГЕНДА НА ДИСПЛЕЯ

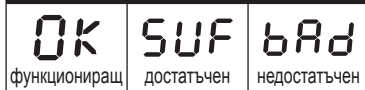

В ТЕСТ

АЛТЕРНАТОР



1 ИЗБОР НА ТЕСТ

FUNCTION



2 СВЪРЗВАНЕ НА ЩИПКИТЕ

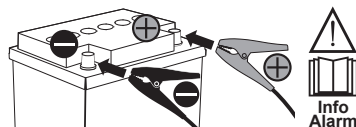

3 ИЗБОР НА НАПРЕЖЕНИЕ

VOLT



4 ПУСКАНЕ НА АВТОМОБИЛА



5 КРАЙ НА ТЕСТА - ПРИМЕР



ЛЕГЕНДА НА ДИСПЛЕЯ

OK	SUF	bAd
функциониращ	достатъчен	недостатъчен

С ПОДДРЪЖКА

ДЕСУЛФАТИЗАЦИЯ

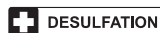

1 ИЗБОР НА УСЪВЪРШЕНСТВАНО МЕНЮ

FUNCTION



2 ИЗБОР НА ФУНКЦИЯ

FUNCTION



3 ИЗБОР НА НАПРЕЖЕНИЕ

VOLT



4 СВЪРЗВАНЕ НА ЩИПКИТЕ

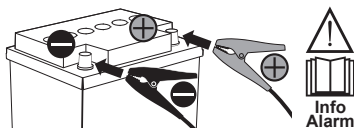

ПУСКАНЕ СЛЕД 5''

5 КРАЙ НА ПРОЦЕСА - ПРИМЕР

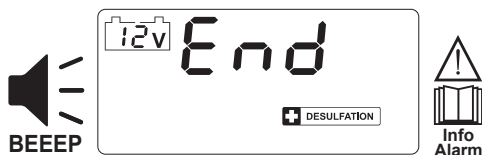

6 ИЗХОД ОТ УСЪВЪРШЕНСТВАНО МЕНЮ

FUNCTION



С ПОДДРЪЖКА

СТАБИЛИЗИРАНЕ

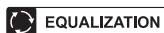

1 ИЗБОР НА УСЪВЪРШЕНСТВАНО МЕНЮ

FUNCTION

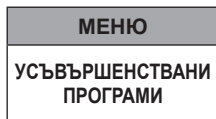

4 СВЪРЗВАНЕ НА ЩИПКИТЕ

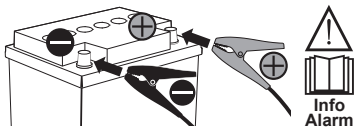

ПУСКАНЕ СЛЕД 5"

2 ИЗБОР НА ФУНКЦИЯ

FUNCTION



5 КРАЙ НА ПРОЦЕСА - ПРИМЕР

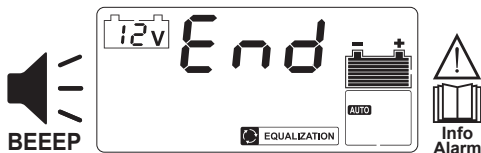

3 ИЗБОР НА НАПРЕЖЕНИЕ

VOLT



6 ИЗХОД ОТ УСЪВЪРШЕНСТВАНО МЕНЮ

FUNCTION



3A ПЕРСОНАЛИЗИРАНЕ НА НАПРЕЖЕНИЕТО - ПРИМЕР



ПРОВЕРЕТЕ ТИПА НА АКУМУЛАТОРА (WET, EFB, GEL, AGM +, Li) И МАКС. ДОПУСТИМОТО НАПРЕЖЕНИЕ.

VOLT



FUNCTION



БЛОКИРАНЕ / РАЗБЛОКИРАНЕ НА КЛАВИАТУРАТА

БЛОКИРАНЕ

VOLT



MODE



ДИСПЛЕЙ



РАЗБЛОКИРАНЕ

VOLT



MODE



ДИСПЛЕЙ

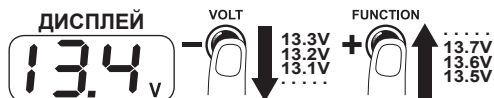

D ЗАХРАНВАНЕ

ЗАХРАНВАЩО УСТРОЙСТВО

SUPPLY

СМЯНА
НА АКУМУЛАТОР

1 ИЗБОР НА УСЪВЪРШЕНСТВАНО МЕНЮ

FUNCTION

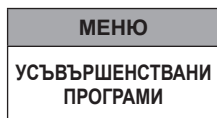

2 ИЗБОР НА ФУНКЦИЯ

FUNCTION



ДИСПЛЕЙ

SUPPLY



НАЛИЧИЕ НА НАПРЕЖЕНИЕ МЕЖДУ
ЩИПКИТЕ (МАХ 27V).

3 ИЗБОР НА НАПРЕЖЕНИЕ

VOLT



ДИСПЛЕЙ

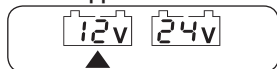

3A ПЕРСОНАЛИЗИРАНЕ НА НАПРЕЖЕНИЕТО - ПРИМЕР



ПРОВЕРЕТЕ В СПЕЦИФИКАЦИИТЕ НА
ПРОИЗВОДИТЕЛЯ НА АВТОМОБИЛА
МАКС. ДОПУСТИМОТО НАПРЕЖЕНИЕ.

VOLT



FUNCTION



ДИСПЛЕЙ



VOLT



13.3V
13.2V
13.1V

FUNCTION



13.7V
13.6V
13.5V

3B ПЕРСОНАЛИЗИРАНЕ НА ТОКА - ПРИМЕР

MODE

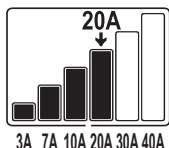
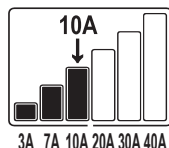

4 ДИСПЛЕЙ - ПРИМЕР



5 СВЪРЗВАНЕ НА ЩИПКИТЕ С КАБЕЛИТЕ НА АКУМУЛАТОРА НА АВТОМОБИЛА

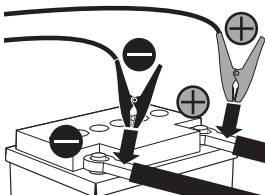

6



ОТСТРАНЯВАНЕ
НА АКУМУЛАТОРА



СМЯНА
НА АКУМУЛАТОРА

7 ИЗХОД ОТ УСЪВЪРШЕНСТВАНО МЕНЮ

FUNCTION



БЛОКИРАНЕ / РАЗБЛОКИРАНЕ НА КЛАВИАТУРАТА

БЛОКИРАНЕ

VOLT



MODE



ДИСПЛЕЙ

Lok on

РАЗБЛОКИРАНЕ

VOLT



MODE



ДИСПЛЕЙ

Lok off

E СТАРТИРАНЕ

START

12v

1 ИЗБОР НА ФУНКЦИЯ

MODE



ДИСПЛЕЙ

START

2 ИЗБОР НА НАПРЕЖЕНИЕ

VOLT



ДИСПЛЕЙ

12v 24v



3 СВЪРЗВАНЕ НА ЩИПКИТЕ КЪМ АКУМУЛАТОРА

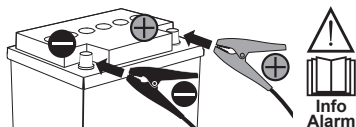

ДИСПЛЕЙ

00

4 ПУСКАНЕ НА АВТОМОБИЛА



5 ТАЙМЕР 30" ЗА СЛЕДВАЩО ПУСКАНЕ

ДИСПЛЕЙ

30
29
28

6 ИЗХОД ОТ ФУНКЦИЯТА

MODE



ИНФОРМАЦИЯ АЛАРМИ



AL 1

КЪСО СЪЕДИНЕНИЕ

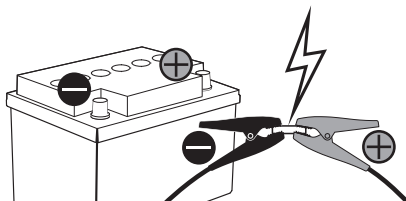

ОБРЪЩАНЕ НА ПОЛЯРНОСТТА

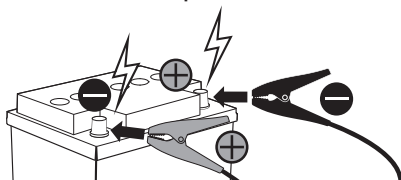

AL 2

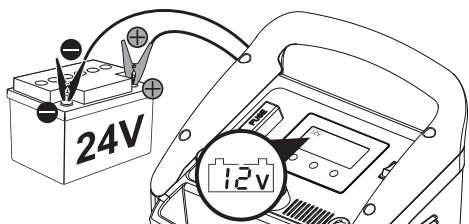

AL 4

AL 5

AL 6

AL 7

AL 8

Pulse *mm*
Tronic



AL 9

КЪСО СЪЕДИНЕНИЕ

EQUALIZATION

DIAGNOSTIC

SUPPLY

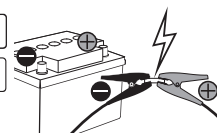

СИГНАЛИЗАЦИЯ ПРЕГРЯВАНЕ
Автоматично възстановяване на работата

000

АЛАРМА ТЕРМИЧНА

00

WYŚWIETLACZ LCD (str. 2)

1. Ustawione napięcie akumulatora.
2. Główny wyświetlacz: zmierzone napięcie-prąd akumulatora, ustawione Ah, wartość napięcia wybrana dla programów Supply / Equalization, wiadomości interfejsowe przeznaczone dla operatora, kody alarmu.
3. Alarm sygnalizujący zmianę biegunowości, zwarcie, zużyty lub uszkodzony akumulator.
4. Ustawiony prąd i napięcie. Kody alarmu "AL1 - AL9".
5. Stan naładowania akumulatora.
6. Wybór prądu ładowania PULSE-TRONIC: AUTO, BOOST, Spersonalizowany (ustawienie Ah).
7. Funkcjonowanie w niskich temperaturach.
9. Tryb EQUALIZATION.
10. Tryb DESULFATION.
11. Wybór typologii akumulatora:
WET: akumulatory ołowiowe, elektrolit ciekły;
GEL: akumulatory ołowiowe, zaplombowane, elektrolit stały;
AGM: akumulatory ołowiowe, zaplombowane, elektrolit na materiale absorbującym;
+ (CA): akumulatory ołowiowo-wapniowe.
12. Tryb SUPPLY.
14. Fazy ładowania PULSE-TRONIC.
15. Tryb START.
16. Automatyczny tryb ładowania.
17. Ładowanie w trybie PULSE-TRONIC.
18. Test funkcjonowania obwodu ładowania (alternator).
19. Test zdolności uruchamiania akumulatora - CCA.
20. Test stanu naładowania akumulatora.
21. VOLT - Przycisk ustawiania:
- napięcie akumulatora 12/24V;
- regulacja napięcia/Ah.
22. FUNCTION - Przycisk ustawiania:
- ŁADOWANIE PULSE -TRONIC (AUTO, AUTO \star , WET, EFB, GEL, AGM +, Li);
- TEST (stan akumulatora, alternator pojazdu, zdolność uruchamiania akumulatorów);
- Programy Zaawansowane (DESULFATION, EQUALIZATION, SUPPLY);
- regulacja napięcia/Ah.
23. FUNCTION - Przycisk ustawiania:
- prąd wyjściowy (AUTO, BOOST, spersonalizowany);
- Tryb START.

FUNKCJE

- A. ŁADOWANIE PULSE TRONIC
- B. TEST
 - TEST STANU NAŁADOWANIA
 - TEST ZDOLNOŚCI URUCHAMIANIA AKUMULATORA (CCA)
 - TEST ALTERNATORA
- C. KONSERWACJA AKUMULATORÓW
 - KOREKCJA
 - ODSIARCZANIE
- D. ZASILANIE
 - ZASILANIE
- E. URUCHAMIANIE - START

INFORMACJE O ALARMACH

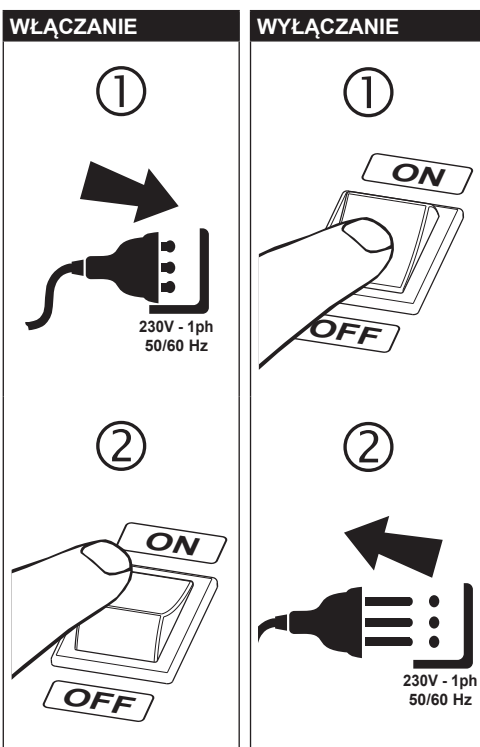

A ŁADOWANIE/PODTRZYMYWANIE

TECHNOLOGIA PULSE-TRONIC

Pulse^{TRONIC}



1 USTAWIENIE PULSE-TRONIC

FUNCTION



WYŚWIETLACZ

Pulse^{TRONIC}

2 USTAWIANIE TYPOLOGII AKUMULATORA

FUNCTION



WYŚWIETLACZ



AUTOMATYCZNE

AUTOMATYCZNE
ZIMA T<0°C

RĘCZNE

3 USTAWIANIE PRĄDU

MODE



WYŚWIETLACZ



AUTOMATYCZNE

SZYBKIE
ŁADOWANIE

RĘCZNE

3A (●) USTAWIANIE Ah - PRZYKŁAD

MODE

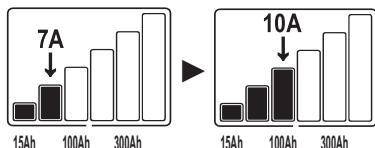

WYŚWIETLACZ

85 Ah

VOLT



80Ah
75Ah
70Ah

FUNCTION



100Ah
95Ah
90Ah

4 WYBÓR NAPIĘCIA

VOLT



WYŚWIETLACZ

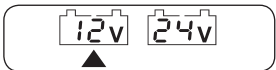

5 PODŁĄCZENIE KLESZCZY

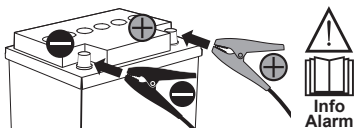

URUCHAMIANIE PO UPŁYWIE 5"

6 WYKRES PULSE-TRONIC

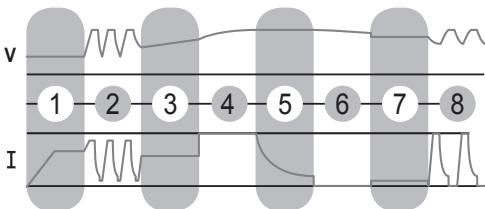

1 Test akumulatora

2 Odzysk akumulatorów zasiarczonych/bardzo rozładowanych

3 Kontrola stanu

4 Ładowanie do 80%

5 Ładowanie do 100%

6 Monitorowanie utrzymywania naładowania

7 Utrzymywanie naładowania

8 Przywracanie naładowania w trybie impulsowym

7 KONIEC ŁADOWANIA - PRZYKŁAD



B TEST

STAN NAŁADOWANIA



1 USTAWIANIE TESTU

FUNCTION



WYŚWIETLACZ

TEST



2 USTAWIANIE TYPOLOGII AKUMULATORA

FUNCTION



WYŚWIETLACZ

WET EFB GEL AGM + Li



3 PODŁĄCZENIE KLESZCZY

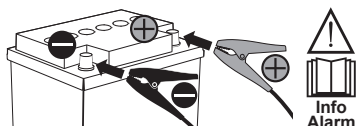

4 WYBÓR NAPIĘCIA

VOLT



WYŚWIETLACZ

12V 24V



5 KONIEC TESTU - PRZYKŁAD



LEGENDA WYŚWIETLACZA



do naładowania



do naładowania



naładowany

B TEST

ZDOLNOŚĆ URUCHAMIANIA AKUMULATORA



1 USTAWIANIE TESTU

FUNCTION



WYŚWIETLACZ

TEST



2 PODŁĄCZENIE KLESZCZY

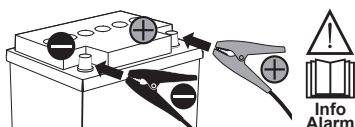

3 WYBÓR NAPIĘCIA

VOLT



WYŚWIETLACZ

12V 24V



WYŚWIETLACZ

Go

4 ROZRUCH POJAZDU



5 KONIEC TESTU - PRZYKŁAD



LEGENDA WYŚWIETLACZA

OK

funkcjonujący

SUF

wystarczający

bAd

niewystarczający

B TEST

ALTERNATOR



1 USTAWIANIE TESTU

FUNCTION



2 PODŁĄCZENIE KLESZCZY

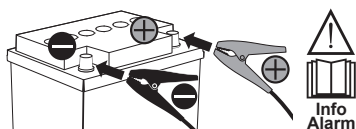

3 WYBÓR NAPIĘCIA

VOLT

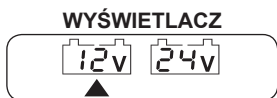

WYŚWIETLACZ



4 ROZRUCH POJAZDU



5 KONIEC TESTU - PRZYKŁAD



LEGENDA WYŚWIETLACZA

OK

funkcjonujący

SUF

wystarczający

bAd

niewystarczający

C KONSERWACJA

ODSIARCZANIE

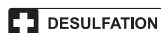

1 WYBÓR MENU ZAAWANSOWANEGO

FUNCTION



2 WYBÓR FUNKCJI

FUNCTION



WYŚWIETLACZ

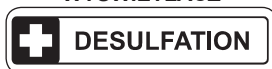

3 WYBÓR NAPIĘCIA

VOLT

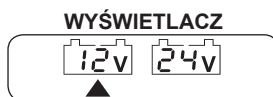

4 PODŁĄCZENIE KLESZCZY

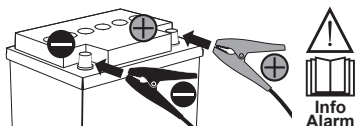

URUCHAMIANIE PO UPŁYWIE 5"

5 KONIEC PROCESU - PRZYKŁAD



6 WYJŚCIE Z MENU ZAAWANSOWANEGO

FUNCTION



C KONSERWACJA

KOREKCJA

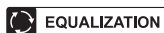

1 WYBÓR MENU ZAAWANSOWANEGO

FUNCTION

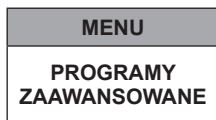

4 PODŁĄCZENIE KLESZCZY

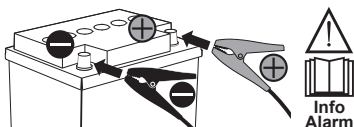

URUCHAMIANIE PO UPŁYWIE 5''

2 WYBÓR FUNKCJI

FUNCTION



WYŚWIETLACZ



5 KONIEC PROCESU - PRZYKŁAD

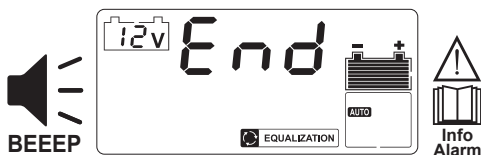

3 WYBÓR NAPIĘCIA

VOLT



WYŚWIETLACZ

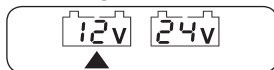

6 WYJŚCIE Z MENU ZAAWANSOWANEGO

FUNCTION



3A SPERSONALIZOWANIE NAPIĘCIA - PRZYKŁAD



SPRAWDZIĆ TYP AKUMULATORA (WET, EFB, GEL, AGM +, Li) I MAX. DOPUSZCZALNE NAPIĘCIE.

VOLT



FUNCTION



ZABLOKOWANIE/ODBLOKOWANIE KLAWIATURY

ZABLOKOWANIE

VOLT



MODE



WYŚWIETLACZ



ODBLOKOWANIE

VOLT



MODE



WYŚWIETLACZ

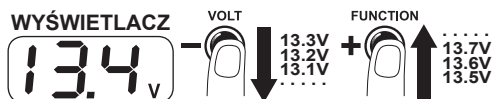

D ZASILANIE

ZASILACZ

SUPPLY

WYMIANA
AKUMULATORA

1 WYBÓR MENU ZAAWANSOWANEGO

FUNCTION

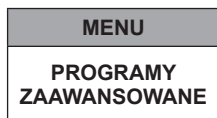

2 WYBÓR FUNKCJI

FUNCTION



WYŚWIETLACZ



OBCENOCĆ NAPIĘCIA MIĘDZY
KLESZCZAMI (MAX 27V).

3 WYBÓR NAPIĘCIA

VOLT



WYŚWIETLACZ

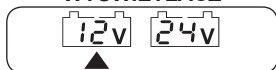

3A SPERSONALIZOWANIE NAPIĘCIA - PRZYKŁAD



SPRAWDŹ W SPECYFIKACJACH
PRODUKENTA POJAZDU MAX.
NAPIĘCIE DOPUSZCZALNE.

VOLT



FUNCTION



3"

WYŚWIETLACZ



VOLT



FUNCTION



13.3V
13.2V
13.1V

13.7V
13.6V
13.5V

3B SPERSONALIZOWANIE PRĄDU - PRZYKŁAD

MODE

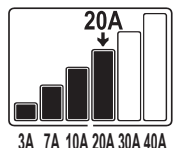
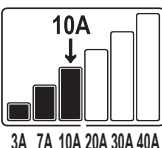

4 WYŚWIETLACZ - PRZYKŁAD



5 POŁĄCZENIE KLESZCZY Z KABLAMI AKUMULATORA POJAZDU

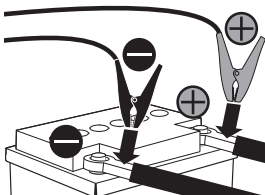

6



WYMONTOWANIE
AKUMULATORA



WYMIANA
AKUMULATORA

7 WYJŚCIE Z MENU ZAAWANSOWANEGO

FUNCTION



ZABLOKOWANIE/ODBLOKOWANIE KLAWIATURY

ZABLOKOWANIE

VOLT



MODE



WYŚWIETLACZ



ODBLOKOWANIE

VOLT



MODE



WYŚWIETLACZ



E URUCHAMIANIE

START

12V

1 WYBÓR FUNKCJI

MODE



WYŚWIETLACZ

START

2 WYBÓR NAPIĘCIA

VOLT



WYŚWIETLACZ

12V 24V



3 PODŁĄCZENIE KLESZCZY DO AKUMULATORA

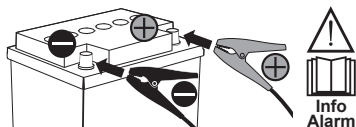

WYŚWIETLACZ

Go

4 ROZRUCH POJAZDU



5 TIMER 30" DO NASTĘPNEGO URUCHAMIANIA

WYŚWIETLACZ

30
29
28

6 WYJŚCIE Z FUNKCJI

MODE



INFORMACJE O ALARMACH



Info Alarm

AL 1

ZWARCIE

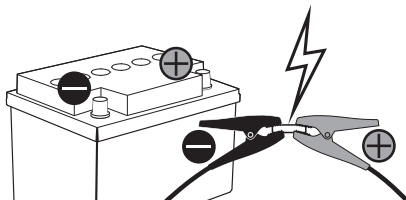

ODWROTNA POLARYZACJA

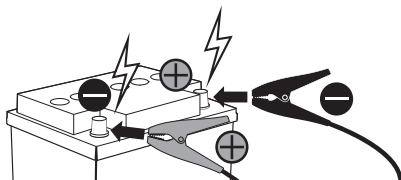

AL 2

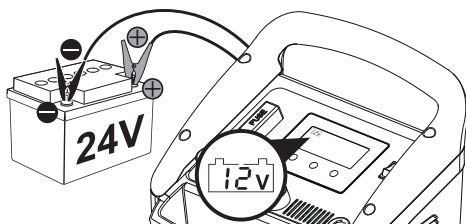

AL 4

AL 5

AL 6

AL 7

AL 8

Pulse *mm*
Tronic



AL 9

ZWARCIE

EQUALIZATION

DIAGNOSTIC

SUPPLY

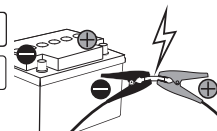

SYGNALIZACJA PRZEGRZANIE
Reset automatyczny

000



ALARM WYŁĄCZNIK TERMICZNY

00



- A. الشحن بالناضج الالكتروني
- B. اختبار
 - اختبار حالة الشحن
 - اختبار قدرة بدء تشغيل البطارية (CCA)
 - اختبار المبادل
- C. صيانة البطارية
 - التخلص من الفسفور
 - التعادل
 - التغذية
 - الامداد
- E. بدء التشغيل - START

معلومات عن التحذيرات

1. جهد البطارية المعد مسبقاً.
2. شاشة أساسية: الجهد-التيار مقاس بالبطارية، الامبير ساعة المختار، قيمة الجهد المختار لبرامج الامداد/المعادل، الرسائل تجاه العامل، رموز التحذيرات.
3. تحذير استبدال الاقطاب، الدائرة القصيرة، بطارية متهالكة أو تالفة.
4. التيار والجهد اللذان تم إعدادهما.
5. رموز التحذير "AL1 - AL9".
6. مستوى شحن البطارية.
7. اختيار تيار الشحن نابض-اوتوماتيكي: AUTO و BOOST و مشخصة (إعداد الامبير ساعة).
8. تشغيل على أساس درجات الحرارة.
9. طريقة المعادل.
10. طريقة إزالة الفسفور.
11. اختيار نوع البطارية:

- WET: بطارية تعمل بالريصاص، الكتروليت سائل.
- GEL: بطارية تعمل بالريصاص، محكمة الغلق، الكتروليت صلب.
- AGM: بطارية تعمل بالريصاص، محكمة الغلق، الكتروليت على خامة ممتصة.
- + (CA): بطارية بريصاص الكالسيوم.
- 12. طرق الامداد.
- 13. مراحل الشحن PULSE-TRONIC.
- 14. طريقة بدء التشغيل.
- 15. طريقة الشحن الاوتوماتيكي.
- 16. طريقة شحن اناضج الالكتروني.
- 17. اختبار تشغيل دائرة إعادة الشحن (مبادل).
- 18. اختبار قدرة بدء تشغيل البطارية - CCA.
- 19. زر حالة شحن البطارية.
- 20. الفولت: إعدادات الزر:
 - جهد البطارية 12 و 24 فولت.
 - ضبط الفولت / أمبير ساعة.
- 21. وظيفة: إعدادات الزر:
 - الشحن بطريقة الناضج الالكتروني (AUTO و *AUTO و WET و EFB و GEL و AGM + و Li).
 - اختبار (حالة البطارية، مبادل المركبة، قدرة بدء تشغيل البطارية).
 - برامج متقدمة (التخلص من الفسفور، التعادل، الامداد).
 - ضبط الفولت / أمبير ساعة.
- 22. طريقة: إعدادات الزر:
 - التيار الخارج (AUTO و BOOST و مشخص).
 - طريقة بدء التشغيل START.

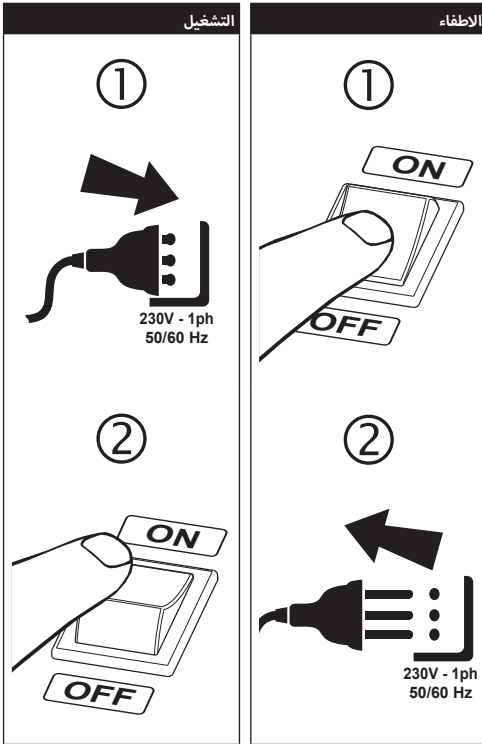

WET EFB GEL AGM (CA) Li Pulse Tronic

الناضج - تكنولوجيا الكترولونية

5 توصيل المشابك

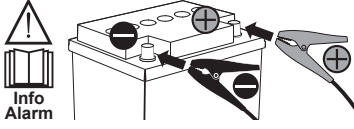

البدء بعد 5 دقائق

6 شكل بياني للناضج-الالكترولوني

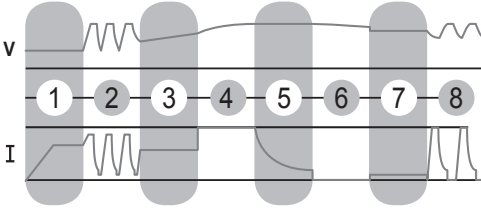

- 1 اختبار على البطارية
- 2 استعادة بطارية مفسفرة/فارغة للغاية
- 3 التحقق من التكامل
- 4 الشحن حتى 80%
- 5 الشحن حتى 100%
- 6 شاشة الحفاظ على الشحن
- 7 الحفاظ على الشحن
- 8 استعادة شحن بالنبضات

7 نهاية الشحن - مثال



1 اختيار الناضج-الالكترولوني



2 اختيار نوع البطارية

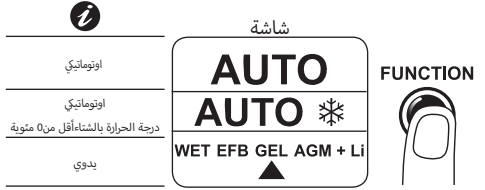

3 اختيار التيار



A3 إعداد قدرة البطارية - Ah مثال

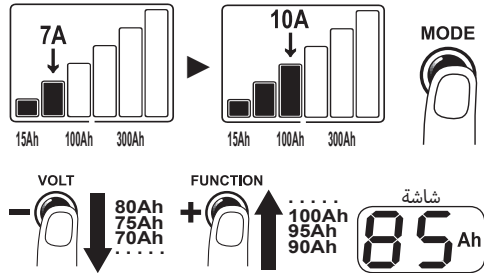

4 اختيار الجهد

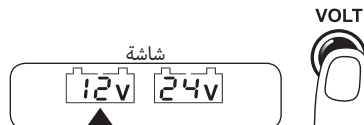



قدرة بدء تشغيل البطارية

1 إختبار اختبار

FUNCTION



2 توصيل المشابك

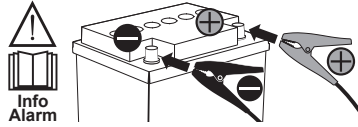

3 إختبار الجهد

VOLT

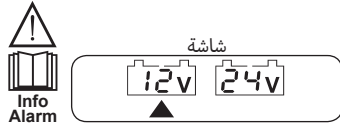

شاشة



4 بدء تشغيل المركبة



5 نهاية الاختبار - مثال



قائمة الشاشة		
OK	SUF	bAd
يعمل	كافي	غير كافي



حالة الشحن

1 إختبار اختبار

FUNCTION



2 إختبار نوع البطارية

FUNCTION



3 توصيل المشابك

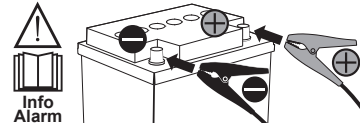

4 إختبار الجهد

VOLT

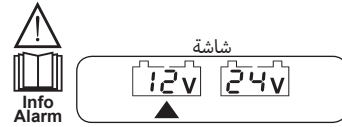

5 نهاية الاختبار - مثال



قائمة الشاشة		
يجب الشحن	يجب الشحن	مشحون

DESULFATION

التخلص من الكبريتات

1 اختيار قائمة الاختيارات المتقدمة

قائمة
متقدم برامج

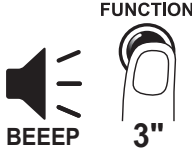

2 اختيار وظيفة



3 اختيار الجهد

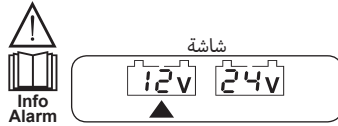

4 توصيل المشابك



5 نهاية الصجريات - مثال

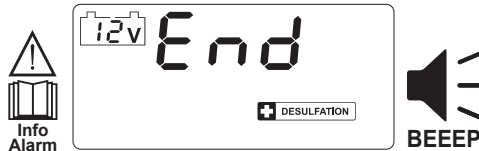

6 الخروج من قائمة الاختيارات المتقدمة

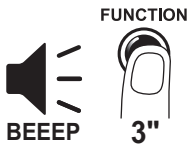

مبادل

1 اختيار اختبار



2 توصيل المشابك

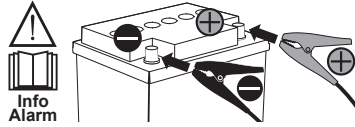

3 اختيار الجهد

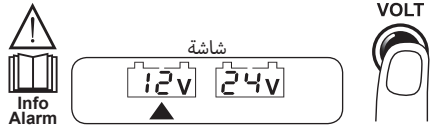

شاشة



4 بدء تشغيل المركبة



5 نهاية الاختبار - مثال



قائمة الشاشة

OK	SUF	bAd
يعمل	كافي	غير كافي

4 توصيل المشابك

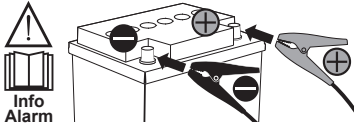

البدء بعد 5 دقائق

5 نهاية المجريات - مثال

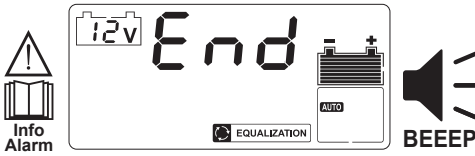

1 اختيار قائمة الاختيارات المتقدمة



2 اختيار وظيفة



6 الخروج من قائمة الاختيارات المتقدمة

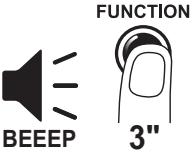

3 اختيار الجهد

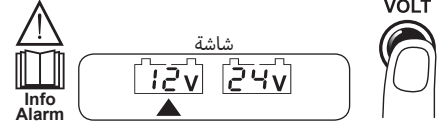

A3 تشخيص الجهد - مثال

التحقق من نوع البطارية (WET أو EFB أو GEL أو AGM + أو Li) وأقصى حد من التيار المسموح به.



غلق/فتح لوحة المفاتيح

غلق

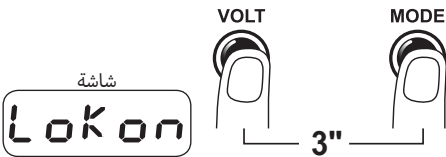

فتح

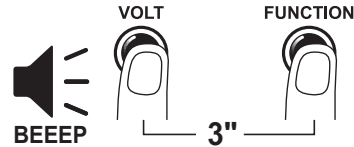
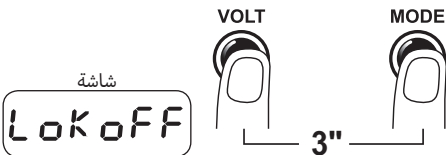

تغيير
بطارية

SUPPLY

4 شاشة-مثال



5 توصيل المشابك بكابلات بطارية المركبة

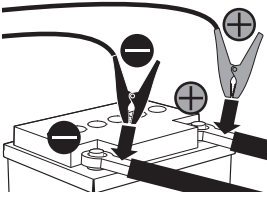

6 المركبة مغذاة بالبطاقة



7 الخروج من قائمة الاختيارات المتقدمة

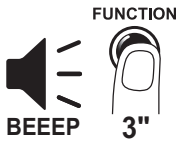

غلق/فتح لوحة المفاتيح

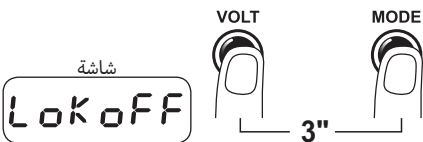
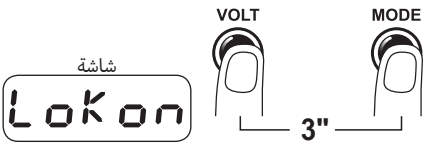

1 اختيار قائمة الاختيارات المتقدمة

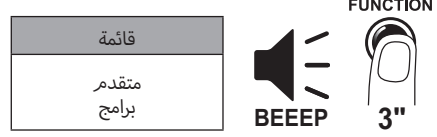

2 اختيار وظيفة



وجود جهد بين المشابك (MAX 27 فولت).

3 اختيار الجهد



A3 تشخيص الجهد - مثال

التحقق من الخصائص الفنية للمركبة لإقصى حد من التيار المسموح به.



B3 تشخيص التيار - مثال

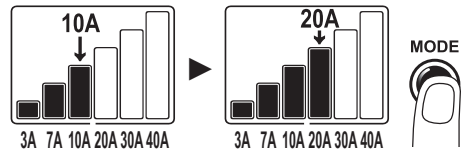

AL 1
دائرة قصيرة

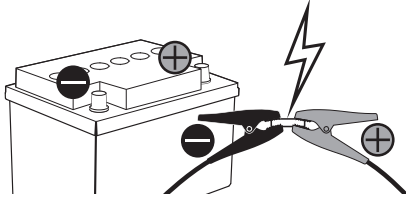

استبدال الاقطاب

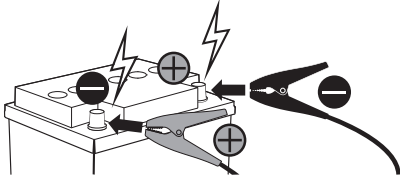

AL 2

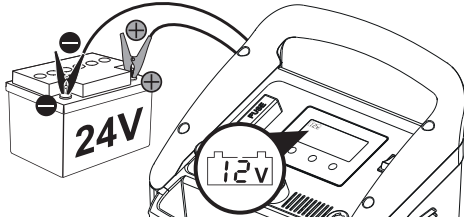

Pulse Tronic

KO+

AL 4
AL 5
AL 6
AL 7
AL 8

AL 9
اثره قصيرة

EQUALIZATION
DIAGNOSTIC
SUPPLY

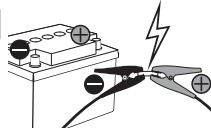

تحذير
حراري

OC ⚠

إشارة
سخونة زائدة
إعادة تشغيل تلقائية

000 ⚠

12V

بدء التشغيل

1 اختيار وظيفة

MODE



شاشة

START

3"

2 اختيار الجهد

VOLT



شاشة

12V 24V



3 توصيل المشابك بالبطارية

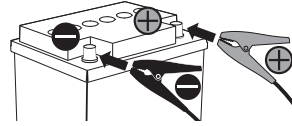

شاشة

Go

4 بدء تشغيل المركبة



5 مؤقت 30 دقيقة لبدء التشغيل التالي

شاشة

30
29
28

6 الخروج من وظيفة

MODE



(EN) GUARANTEE

The manufacturer guarantees proper operation of the machines and undertakes to replace free of charge any parts should they be damaged due to poor quality of materials or manufacturing defects within 12 months of the date of commissioning of the machine, when proven by certification. Returned machines, also under guarantee, should be dispatched CARRIAGE PAID and will be returned CARRIAGE FORWARD. This with the exception of, as decreed, machines considered as consumer goods according to European directive 1999/44/EC, only when sold in member states of the EU. The guarantee certificate is only valid when accompanied by an official receipt or delivery note. Problems arising from improper use, tampering or negligence are excluded from the guarantee. Furthermore, the manufacturer declines any liability for all direct or indirect damages.

(IT) GARANZIA

La ditta costruttrice si rende garante del buon funzionamento delle macchine e si impegna ad effettuare gratuitamente la sostituzione dei pezzi che si deteriorassero per cattiva qualità di materiale e per difetti di costruzione entro 12 mesi dalla data di messa in funzione della macchina, comprovata sul certificato. Le macchine rese, anche se in garanzia, dovranno essere spedite in PORTO FRANCO e verranno restituite in PORTO ASSEGNATO. Fanno eccezione, a quanto stabilito, le macchine che rientrano come beni di consumo secondo la direttiva europea 1999/44/CE, solo se vendute negli stati membri della EU. Il certificato di garanzia ha validità solo se accompagnato da scontrino fiscale o bolla di consegna. Gli inconvenienti derivati da cattiva utilizzazione, manomissione o incuria, sono esclusi dalla garanzia. Inoltre si declina ogni responsabilità per tutti i danni diretti ed indiretti.

(FR) GARANTIE

Le fabricant garantit le fonctionnement correct des machines et s'engage à remplacer gratuitement les composants endommagés à la suite d'une mauvaise qualité de matériel ou d'un défaut de fabrication durant une période de 12 mois à compter de la mise en service de la machine attestée par le certificat. Les machines rendues, même sous garantie, doivent être expédiées en FRANCO DESTINATION et seront renvoyées en PORT DÛ. Font exception à cette règle les machines considérées comme biens de consommation selon la directive européenne 1999/44/CE et vendues aux états membres de l'EU uniquement. Le certificat de garantie n'est valable que s'il est accompagné de la preuve d'achat ou du bulletin de livraison. Tous les inconvénients dus à une utilisation incorrecte, une manipulation ou une négligence sont exclus de la garantie. La société décline en outre toute responsabilité pour tous les dommages directs ou indirects.

(ES) GARANTÍA

La empresa fabricante garantiza el buen funcionamiento de las máquinas y se compromete a efectuar gratuitamente la sustitución de las piezas que se deterioren por mala calidad del material y por defectos de fabricación en los 12 meses posteriores a la fecha de puesta en funcionamiento de la máquina, comprobada en el certificado. Las máquinas entregadas, incluso en garantía, deberán ser enviadas a PORTE PAGADO y se devolverán a PORTE DEBIDO. Son excepción, según cuanto establecido, las máquinas que se consideran bienes de consumo según la directiva europea 1999/44/CE sólo si han sido vendidas en los estados miembros de la UE. El certificado de garantía tiene validez sólo si está acompañado de resguardo fiscal o albarán de entrega. Los problemas derivados de una mala utilización, modificación o negligencia están excluidos de la garantía. Además, se declina cualquier responsabilidad por todos los daños directos e indirectos.

(DE) GEWÄHRLEISTUNG

Der Hersteller übernimmt die Gewährleistung für den einwandfreien Betrieb der Maschinen und verpflichtet sich, solche Teile kostenlos zu ersetzen, die aufgrund schlechter Materialqualität und von Herstellungsfehlern innerhalb von 12 Monaten ab der Inbetriebnahme schadhafte werden. Als Nachweis der Inbetriebnahme gilt der Garantieschein. Werden Maschinen zurückgeschickt, muß dies - auch im Rahmen der Gewährleistung - FRACHTFREI geschehen. Sie werden anschließend per FRACHTNACHNAME wieder zurückgeschickt. Von den Regelungen ausgenommen sind Maschinen, die nach der Europäischen Richtlinie 1999/44/EG unter die Verbrauchsgüter fallen, und nur dann, wenn sie in einem Mitgliedstaat der EU verkauft worden sind. Der Garantieschein ist nur gültig, wenn ihm der Kassenbon oder der Lieferschein beiliegt. Unsere Gewährleistung bezieht sich nicht auf Schäden aufgrund fehlerhafter oder nachlässiger Behandlung oder aufgrund von Fremdeinwirkung. Außerdem wird jede Haftung für direkte und indirekte Schäden ausgeschlossen.

(RU) ГАРАНТИЯ

Компания-производитель гарантирует хорошую работу машинного оборудования и обязуется бесплатно произвести замену частей, имеющих неисправности, явившиеся следствием плохого качества материала или дефектов производства, в течении 12 месяцев с даты пуска в эксплуатацию машинного оборудования, проставленной на сертификате. Возвращенное оборудование, даже находящееся под действием гарантии, должно быть направлено на условиях ПОРТО ФРАНКО и будет возвращено в УКАЗАННОЕ МЕСТО. Из оговоренного выше исключается машинное оборудование, считающееся товарами потребления, в соответствии с европейской директивой 1999/44/ЕС, только в том случае, если они были проданы в государствах, входящих в ЕС. Гарантийный сертификат считается действительным только при условии, что к нему прилагается товарный чек или товаросопроводительная накладная. Неисправности, возникшие из-за неправильного использования, порчи или небрежного обращения, не покрываются действием гарантии. Дополнительно производитель снимает с себя любую ответственность за какой-либо прямой или непрямо́й ущерб.

(PT) GARANTIA

A empresa fabricante torna-se garante do bom funcionamento das máquinas e compromete-se a efectuar gratuitamente a substituição das peças que porventura se deteriorarem devido à má qualidade de material e por defeitos de fabricação no prazo de 12 meses da data de entrada da máquina em funcionamento, comprovada no certificado. As máquinas devolvidas, mesmo se em garantia, deverão ser despachadas em PORTO FRANCO e serão devolvidas com FRETE A PAGAR. São excepção, a quanto estabelecido, as máquinas que são consideradas como bens de consumo segundo a directiva europeia 1999/44/CE, somente se vendidas nos estados-membros da EU. O certificado de garantia tem validade somente se acompanhado pela nota fiscal ou conhecimento de entrega. Os inconvenientes decorrentes de utilização imprópria, adulteração ou descuido, são excluídos da garantia. Para além disso, o fabricante exime-se de qualquer responsabilidade para todos os danos directos e indirectos.

(EL) ΕΓΓΥΗΣΗ

Η κατασκευαστική εταιρία εγγυάται την καλή λειτουργία των μηχανών και δεσμεύεται να εκτελέσει δωρεάν την αντικατάσταση τμημάτων σε περίπτωση φθοράς τους εξαιτίας κακής ποιότητας υλικού ή ελαττωμάτων κατασκευής, εντός 12 μηνών από την ημερομηνία θέσης σε λειτουργίας του μηχανήματος επιβεβαιωμένη από το πιστοποιητικό. Τα μηχανήματα που επιστρέφονται, ακόμα και αν είναι σε εγγύηση, θα στέλνονται ΧΩΡΙΣ ΕΠΙΒΑΡΥΝΣΗ και θα επιστρέφονται με έξοδα ΠΛΗΡΩΤΕΑ ΣΤΟΝ ΠΡΟΟΡΙΣΜΟ. Εξαιρούνται από τα οριζόμενα τα μηχανήματα που αποτελούν καταναλωτικά αγαθά σύμφωνα με την ευρωπαϊκή οδηγία 1999/44/EC μόνο αν πωλούνται σε κράτη μέλη της ΕΕ. Το πιστοποιητικό εγγύησης ισχύει μόνο αν συνοδεύεται από επίσημη απόδειξη πληρωμής ή απόδειξη παραλαβής. Ενδεχόμενα προβλήματα οφειλόμενα σε κακή χρήση, παραποίηση ή αμέλεια, αποκλείονται από την εγγύηση. Απορρίπτεται, επίσης, κάθε ευθύνη για οποιαδήποτε βλάβη άμεση ή έμμεση.

(NL) GARANTIE

De fabrikant is garant voor de goede werking van de machines en verplicht er zich toe gratis de vervanging uit te voeren van de stukken die afsluiten omwille van de slechte kwaliteit van het materiaal en omwille van fabricagefouten, binnen de 12 maanden vanaf de datum van in bedrijfstelling van de machine, bevestigd op het certificaat. De geretoureerde machines, ook al zijn ze in garantie, moeten PORTVRIJ verzonden worden en zullen op KOSTEN BESTEMMELING teruggestuurd worden. Hierop maken een uitzondering de machines die vallen onder de verbruiksartikelen overeenkomstig de Europese richtlijn, 1999/44/EG, alleen indien ze verkocht zijn in de lidstaten van de EU. Het garantiecertificaat is alleen geldig indien het vergezeld is van de fiscale reçu of van het ontvangstbewijs. De inconvenienten te wijten aan een slecht gebruik, schendingen of nalatigheid zijn uitgesloten uit de garantie. Bovendien wijst men alle verantwoordelijkheid af voor alle rechtstreekse en onrechtstreekse schade.

(HU) JÓTÁLLÁS

A gyártó cég jótállást vállal a gépek rendeltetésszerű üzemeléséért illetve vállalja az alkatrészek ingyenes kicserélését ha azok az alapanyag rossz minőségéből valamint gyártási hibából erednek a gép üzembe helyezésének a bizonylat szerint igazolható napjától számított 12 hónapon belül. A cserélendő alkatrészeket még a jótállás keretében is BÉRMENTESEN kell visszaküldeni, amelyek UTÓVÉTEL lesznek a vevőhöz kiszállítva. Kivételt képeznek e szabály alól azon gépek, melyek az Európai Unió 199/44/EC irányelve szerint meghatározott fogyasztási cikknek minősülnek, s az EU tagországaiban kerültek értékesítésre. A jótállás csak a blokki igazolás illetve szállítólevél mellékletével érvényes. A nem rendeltetésszerű használatból, megrongálásból illetve nem megfelelő gondossággal való kezelésből eredő rendellenességek a jótállást kizárják. Kizárt továbbá bármintemű felelősségvállalás minden közvetlen és közvetett kárért.

(RO) GARANȚIE

Fabricantul garantează buna funcționare a aparatelor produse și se angajează la înlocuirea gratuită a pieselor care s-ar putea deteriora din cauza calității scadente a materialului sau din cauza defectelor de construcție în max. 12 luni de la data punerii în funcțiune a aparatului, dovedită cu certificatul de garanție. Aparatele restituite, chiar dacă sunt în garanție, se vor expedia FĂRĂ PLATĂ și se vor restitui CU PLATA LA PRIMIRE. Fac excepție, conform normelor, aparatele care se categorisesc ca și bunuri de consum, conform directivei europene 1999/44/EC, numai dacă acestea sunt vândute în statele membre din UE. Certificatul de garanție este valabil numai dacă este însoțit de bonul fiscal sau de fișa de livrare. Nefuncționarea cauzată de o utilizare improprie, manipulare inadecvată sau neglijență este exclusă din dreptul la garanție. În plus fabricantul își declină orice responsabilitate față de toate daunele provocate direct și indirect.

(SV) GARANTI

Tillverkaren garanterar att maskinerna fungerar bra och åtar sig att kostnadsfritt byta ut delar som går sönder p.g.a. dålig materialkvalitet och defekter inom 12 månader efter idriftsättningen av maskinen, som ska styras av intyg. De maskiner som lämnas tillbaka, även om de täcks av garantin, måste skickas FRAKTFRITT, och kommer att skickas tillbaka PÅ MOTTAGARENS BEKOSTNAD. Ett undantag från detta utgörs av de maskiner som räknas som konsumtionsvaror enligt EU-direktiv 1999/44/EG, och då enbart om de har sålts till något av EU:s medlemsländer. Garantisedeln är bara giltig tillsammans med kvitto eller leveranssedel. Problem som beror på felaktig användning, åverkan eller vårdslöshet täcks inte av garantin. Tillverkaren fransäger sig även allt ansvar för direkt och indirekt skada.

(DA) GARANTI

Producenten stiller garanti for, at maskinerne fungerer ordentligt, og forpligter sig til vederlagsfrit at udskifte de dele, der måtte fremvise defekter på grund af ringe materialekvalitet eller fabriktionsfejl i løbet af de første 12 måneder efter maskinens idriftsættelsesdato, der fremgår af beviset. Selvom de returnerede maskiner er i garanti, skal de sendes FRANKO FRAGT, mens de tilbageleveres PR. EFTERKRAV. Dette gælder dog ikke for de maskiner, der i henhold til Direktivet 1999/44/EØF udgør forbrugsgoder, men kun på betingelse af at de sælges i EU-landene. Garantibeviset er kun gyldigt, hvis der vedlægges en kassebon eller fragtpapirer. Garantien dækker ikke for forstyrrelser, der skyldes forkert anvendelse, manipulering eller skødesløshed. Producenten fralægger sig desuden ethvert ansvar for alle direkte og indirekte skader.

(NO) GARANTI

Tilvrkeren garanterer maskinens korrekte funksjon og forplikter seg å utføre gratis bytte av deler som blir ødelagt på grunn av en dårlig kvalitet i materialer eller konstruksjonsfeil som oppstår innen 12 måneder fra maskinens igangsetting, i overensstemmelse med sertifikatet. Maskiner som sendes tilbake, også i løpet av garantiperioden, skal skikkes FRAKTFRITT og skal sendes tilbake MED BETALNING AV MOTTAKEREN, unntatt maskinene som tilhører forbrukningsvarer ifølge europadirektiv 1999/44/EC, kun hvis de selges i en av EUs medlemsstater. Garantisertifikatet er gyldig kun sammen med kvittering eller leveringsblankett. Feil som oppstår på grunn av galt bruk, manipulering eller slurv, er utelukket fra garantin. Dessuten frasier seg selskapet alt ansvar for alle direkte og indirekte skader.

(FI) TAKUU

Valmistusyritys takaa koneiden hyvän toimivuuden sekä huolehtii huonolaatuisen materiaalin ja rakennusvirhiden takia huonontuneiden osien vaihdosta ilmaiseksi 12 kuukauden sisällä koneen käyttöönottopäivästä, mikä ilmenee sertifikaatista. Palautettavat koneet, myös takuussa olevat, on lähetettävä LÄHETTÄJÄN KUSTANNUKSELLA ja ne palautetaan VASTAANOTTAJAN KUSTANNUKSELLA. Poikkeuksen muodostavat koneet, jotka asetuksissa kuuluvat kulutushyödykkeisiin eurooppalaisen direktiivin 1999/44/EC mukaan vain, jos ne myydään EU:n jäsen maissa. Takuuodistus on voimassa vain, jos siihen on liitetty verotuskuitti tai todistus tavarain toimiksesta. Takuu ei kata väärinkäytöstä, vaurioittamisesta tai huolimattomuudesta johtuvia haittoja. Lisäksi yritys kieltäytyy ottamasta vastuuta kaikista välittömistä tai välillisistä vaurioista.

(CS) ZÁRUKA

Výrobce ručí za správnou činnost strojů a zavazuje se provést bezplatnou výměnu dílů opotřebovaných z důvodu špatné kvality materiálu a následkem konstrukčních vad do 12 měsíců od data uvedení stroje do provozu, uvedeného na záručním listě. Vrácené stroje a to i v záruční době musí být odeslány se ZAPLACENÝM POŠTOVNÝM a budou vráceny na NÁKLADY PŘÍJEMCE. Na základě dohody tvoří výjimku stroje spadající do spotřebního majetku ve smyslu směrnice 1999/44/ES pouze za předpokladu, že byly prodány v členských státech EU. Záruční list má platnost pouze v případě, že je předložen spolu s účtenkou nebo dodacím listem. Poruchy vyplývající z nesprávného použití, úmyslného poškození nebo chybějící péče nespádají do záruky. Odpovědnost se dále nevztahuje na všechny přímé a nepřímé škody.

(SK) ZÁRUKA

Výrobca ručí za správnu činnosť strojov a zaväzuje sa vykonať bezplatnú výmenu dielov opotrebovaných z dôvodu zlej kvality materiálu a následkom konštrukčných vad do 12 mesiacov od dátumu uvedenia stroja do prevádzky, uvedeného na záručnom liste. Vrátene stroje a to i v podmienkach záručnej doby musia byť odoslané so ZAPLATENÝM POŠTOVNÝM a budú vrátené na NÁKLADY PRÍJEMCU. Na základe dohody výnimku tvoria stroje spadajúce do spotrebného majetku, v zmysle smernice 1999/44/ES, len za predpokladu, že boli predané v členských štátoch EÚ. Záručný list je platný len v prípade, keď je predložený spolu s účtenkou alebo dodacím listom. Poruchy vyplývajúce z nesprávneho použitia, neoprávneného zásahu alebo nedostatočnej starostlivosti nespádajú do záruky. Zodpovednosť sa ďalej nevzťahuje na všetky priame i nepriame škody.

(SL) GARANCIJA

Proizvajalec zagotavlja pravilno delovanje strojev in se zavazuje, da bo brezplačno zamenjal dele, ki se bodo obrabili zaradi slabe kakovosti materiala in zaradi napak pri proizvodnji v roku 12 mesecev od dneva nakupa označenega ne tem certifikatu. Izjema so le aparati, ki so del potrošnih dobrin v skladu z evropsko direktivo 1999/44/EC, le če so bili prodani v državi članici EU. Garancijsko potrdilo je veljavno le, če je priložen veljaven račun. Napake, ki izhajajo iz nepravilne uporabe, posegov ali malomarnosti, garancija ne pokriva. Poleg tega proizvajalec zavrta odgovornost za vse posredne in neposredne poškodbe. Ne delujoč aparat mora pooblaščen servis popraviti v roku 45 dni, v nasprotnem primeru se kupcu izročijo nov aparat. Proizvajalec zagotavlja dobavo rezervnih delov še 5 let od nakupa izdelka. Na podlagi zakona o spremembah in dopolnitvah Zakona o varstvu potrošnikov (ZVPot-E) (Uradni RS št. 78/2011) podjetje Telwin s.p.a., kot organizator servisne mreže izrecno izjavlja: da velja garancija za izdelek na teritorialnem območju države v kateri je izdelek prodan končnim potrošnikom; oপরায়ণ potrošnike, da garancija in uveljavljanje zahtevk iz naslova garancije ne izključuje pravic potrošnika, ki izhajajo iz naslova odgovornosti prodajalca za napake na blagu. ORGANIZATOR SERVISNE SLUŽBE ZA SLOVENIJO: Itehnik d.o.o., Vanganelška cesta 26a, 6000 Koper, tel: 05/625-02-08.

(HR-SR) GARANCIJA

Proizvođač garantira ispravan rad strojeva i obvezuje se izvršiti besplatno zamjenu dijelova koji su oštećeni zbog loše kvalitete materijala i zbog tvorničkih grešaka, u roku od 12 mjeseci od dana pokretanja stroja, koji je potvrđen na garantnom listu. Vraćeni strojevi, i ako su pod garancijom, moraju biti poslani bez plaćanja troškova prijevoza. Iznimka su strojevi koji se vraćaju kao potrošni materijal, u skladu sa Europskom odredbom 1999/44/EC, samo ako su prodani zemljama članicama EU-a. Garantni list vrijedi samo ako je popraćen računom ili dostavnim listom. Oštećenja nastala uslijed neispravne upotrebe, izmjena izvršenih na stroju ili nemara nisu pokriveni garancijom. Proizvođač se ujedno odriče bilo kakve odgovornosti za sve izravne i neizravne štete.

(LT) GARANTIJA

Gamintojas garantuoja nepriekiaštingą įrenginio veikimą ir įsipareigoja nemokamai pakeisti gaminio dalis, susidėvėjusias ar susigadinusias dėl prastos medžiagos kokybės ar dėl konstrukcijos defektų 12 mėnesių laikotarpyje nuo įrenginio paleidimo datos, pat to garantijas laiką, ir įžanosūta saskaņā ar FRANKO-OSTA noteikumiem un ražotājs tās atgriezīs uz NORĀDĪTO OSTU. Minētie nosacījumi neattiecas uz mašīnām, kuras saskaņā ar Eiropas direktīvu 1999/44/EC tiek uzskatītas par patēriņa precī, bet tikai gadījumā, ja tās tiek pārdotas ES dalībvalstīs. Garantijas sertifikāts ir spēkā tikai kopā ar kases čeku vai pavadzīmi. Garantija neattiecas uz gadījumiem, kad bojājumi ir radušies nepareizās izmantošanas, noteikumu neievērošanas vai nolaidības dēļ. Turklāt, šajā gadījumā ražotājs noņem jebkādu atbildību par tiešajiem un netiešajiem zaudējumiem.

(ET) GARANTII

Tootajafirma vastutab masinate hea funktsioneerimise eest ja kohustub asendada tasuta osad, mis riknevad halva kvaliteediga materjali ja konstruktsioonidefektide tõttu, 12 kuus jooksul alates masina käikupanemise sertifikaadil tõestatud kuupäevast. Tagasi saadetavad masinad, ka kehtiva garantiiga, tuleb saata TASUTUD POSTIMAKSUGA ja nende tagastamise SAATEKULUD ON KAUBASAAJA TASUDA. Nagu kehtestatud, teevad erandi masinad, mis kuuluvad euroopa normatiivi 1999/44/EC kohaselt tarbekauba kategooriasse ja ainult siis, kui müüdid ÜE liikmesriikides. Garantiisertifikaat kehtib ainult koos ostu- või kättetoimetamiskviitungiga. Garantii ei hõlma riknemisi, mis on põhjustatud seadme väärest käsitsemisest, modifitseerimisest või hoolimatust kasutamisest. Peale selle ei vastuta firma kõigi otseste või kaudsete kahjude eest.

(LV) GARANTIJA

Ražotājs garantē mašīnu labu darbību un apņemas bez maksas nomainīt detaļas, kuras nodilst materiāla sliktas kvalitātes dēļ vai ražošanas defektu dēļ 12 mēnešu laikā kopš sertifikāta norādītā mašīnas ekspluatācijas sākuma datuma. Atpakaļ nosūtāmas mašīnas, pat to garantijas laikā, ir jānosūta saskaņā ar FRANKO-OSTA noteikumiem un ražotājs tās atgriezīs uz NORĀDĪTO OSTU. Minētie nosacījumi neattiecas uz mašīnām, kuras saskaņā ar Eiropas direktīvu 1999/44/EC tiek uzskatītas par patēriņa precī, bet tikai gadījumā, ja tās tiek pārdotas ES dalībvalstīs. Garantijas sertifikāts ir spēkā tikai kopā ar kases čeku vai pavadzīmi. Garantija neattiecas uz gadījumiem, kad bojājumi ir radušies nepareizās izmantošanas, noteikumu neievērošanas vai nolaidības dēļ. Turklāt, šajā gadījumā ražotājs noņem jebkādu atbildību par tiešajiem un netiešajiem zaudējumiem.

(BG) ГАРАНЦИЯ

Фирмата производител гарантира за доброто функциониране на машините и се задължава да извърши безплатно подмяната на части, които са се повредили, заради некачествен материал или производствени дефекти, до 12 месеца от датата на пускане в действие на машината, доказана с гаранционна карта. Врънатите машини, дори и в гаранция, трябва да бъдат изпратени със ЗАПЛАТЕН ПРЕВОЗ и ще бъдат върнати с НАЛОЖЕН ПЛАТЕЖ. С изключение на машините, които се считат за движимо имущество за постоянно ползване, както е установено от европейската директива 1999/44/EC, само ако машините са продавани в страни членки на Европейския съюз. Гаранционната карта е валидна, само ако е придружена от фискален бон или разписка за доставка. Нередностите, произтичащи от лоша употреба или небрежност, са изключени от гаранцията. Освен това се отклонява всякаква отговорност за директни или индиректни щети.

(PL) GWARANCJA

Producent gwarantuje prawidłowe funkcjonowanie urządzeń i zobowiązuje się do bezpłatnej wymiany części, które zepsują się w wyniku złej jakości materiału lub wad fabrycznych w ciągu 12 miesięcy od daty uruchomienia urządzenia, poświadczonej na gwarancji. Urządzenia przesłane do Producenta, również w okresie gwarancji, należy wysłać na warunkach PORTO FRANKO, po naprawie zostaną one zwrócone na koszt odbiorcy. Zgodnie z ustaleniami wyjątkiem są te urządzenia, które są odsyłane jako dobra konsumpcyjne, zgodnie z dyrektywą europejską 1999/44/WE, wyłącznie, jeżeli zostały sprzedane w krajach członkowskich UE. Karta gwarancyjna jest ważna wyłącznie, jeżeli towarzyszy jej kwit fiskalny lub dowód dostawy. Trudności wynikające z nieprawidłowego użytkowania, naruszenia lub niedbałości o urządzenie nie są objęte gwarancją. Producent nie ponosi odpowiedzialności za wszelkie szkody pośrednie i bezpośrednie.

(AR) الضمان

تضمن الشركة المصنعة جودة الماكينات، كما أنها تتعهد باستبدال قطع مجاناً في حالة تلفها بسبب سوء جودة المادة وعيوب التصنيع وذلك في خلال 12 شهر من تاريخ تشغيل الماكينة المثبت في الشهادة. سترسل الماكينات المسترجعة - حتى وإن كانت في الضمان- على حساب المرسل ويتم استرجاعهم على حساب المستلم. وذلك باستثناء -كما هو مقرر- الماكينات التي تعتبر سلع استهلاكية وفقاً للتوجيه الأوروبي رقم 44 لعام 1999 - الاتحاد الأوروبي "CE/44/1999"، والتي يتم بيعها فقط في الدول الأعضاء في الاتحاد الأوروبي. تسري شهادة الضمان فقط إذا كان معها إيصال أو مذكرة تسليم. لا يشمل الضمان المشاكل التي تنتج عن سوء الاستخدام أو العبث أو الإهمال. كما أنها لا تحمل أي مسؤولية عن جميع الأضرار المباشرة وغير المباشرة.

Table with 5 columns: (EN), (IT), (FR), (ES), (DE), (RU), (PT), (PL) and their corresponding labels in other languages: (NL) GARANTIEBEWIJS, (HU) GARANCIALEVÉL, (RO) CERTIFICAT DE GARANȚIE, (SV) GARANTISEDEL, (DA) GARANTIBEVIS, (NO) GARANTIBEVIS, (FI) TAKUUTODISTUS, (CS) ZÁRUČNÍ LIST, (SK) ZÁRUČNÝ LIST, (SL) CERTIFICAT GARANCIJE, (HR-SR) GARANTNI LIST, (LT) GARANTINIS PAŽYMĖJIMAS, (ET) GARANTISERTIFIKAAT, (LV) GARANTIJAS SERTIFIKĀTS, (BG) ГАРАНЦИОННА КАРТА, (PL) CERTYFIKAT GWARANCJI, (AR) شهادة الضمان

MOD. / MONT / МОДЛ / ÖRLAP / MUDEL / МОДЕЛ / Št / Vr.

(EN) Date of buying - (IT) Data di acquisto - (FR) Date d'achat - (ES) Fecha de compra - (DE) Kaufdatum - (RU) Дата продажи - (PT) Data de compra - (EL) Ημερομηνία αγοράς - (NL) Datum van aankoop - (HU) Vásárlás kelte - (RO) Data achiziției - (SV) Inköpsdatum - (DA) Købsdato - (NO) Innkjøpsdato - (FI) Ostopäivämäärä - (CS) Datum zakoupení - (SK) Dátum zakúpenia - (SL) Datum nakupa - (HR-SR) Datum kupnje - (LT) Pirkimo data - (ET) Ostu kuupäev - (LV) Pirkšanas datums - (BG) ДАТА НА ПОКУПКАТА - (PL) Data zakupu - (AR) تاريخ الشراء

NR. / ARIQM / É. / Ć. / HOMEP:

Table with 2 columns: (EN), (IT), (FR), (ES), (DE), (RU), (PT), (EL), (NL), (HU), (SV), (RO), (DA), (NO), (FI), (CS), (SK), (SL) and their corresponding labels in other languages: (NO) Forhandler (Stempel und underskrift), (FI) Jälleenmyyjä (Leima ja Allekirjoitus), (ES) Proveedor (Razitko a podpis), (SK) Predajca (Pečiatka a podpis), (SL) Prodajno podjetje (Zig in podpis), (HR-SR) Tvrtka prodavatelj (Pečat i potpis), (LT) Pardavėjas (Antspaudas ir Parašas), (ET) Edasimüügi firma (Tempel ja allkiri), (LV) Izplātītājs (Zīmogs un paraksts), (BG) ПРОДАВАЧ (Подпис и Печат), (PL) Firma odpowiedzialna (Pieczęć i Podpis), (AR) شركة المبيعات (ختم وتوقيع)

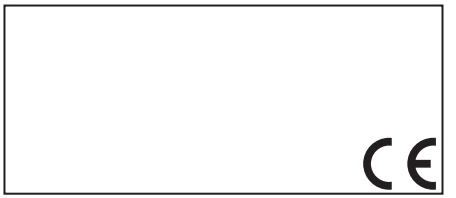

Table with 4 columns: (EN), (IT), (FR), (ES), (DE), (RU), (PT), (EL), (NL), (HU), (SV), (RO), (DA), (NO), (FI), (CS), (SK), (SL), (HR-SR), (LT), (ET), (LV), (BG), (PL), (AR) and their corresponding labels in other languages: (HU) A termék megfelel a következőknek: (HR-SR) Proizvod je u skladu sa: (LT) Produktas atitinka: (ET) Toode on kooskõlas: (LV) Izstrādājums atbilst: (BG) Продуктът отговаря на: (PL) Produkt spełnia wymagania następujących Dyrektyw: (AR) المنتج متوافق مع:

(EN) DIRECTIVES - (IT) DIRETTIVE - (FR) DIRECTIVES - (ES) DIRECTIVAS - (DE) RICHTLIJNEN - (RU) ДИРЕКТИВЫ - (PT) DIRECTIVAS - (EL) ΠΡΟΔΙΑΓΡΑΦΕΣ - (NL) RICHTLIJNEN - (HU) IRÁNYELVEK - (RO) DIRECTIVE - (SV) DIREKTIV - (DA) DIREKTIVER - (NO) DIREKTIVER - (FI) DIREKTIVIIT - (CS) SMĚRNICE - (SK) SMERNICE - (SL) DIREKTIVE - (HR-SR) DIREKTIVE - (LT) DIREKTYVOS - (ET) DIREKTIIVID - (LV) DIREKTĪVAS - (BG) ДИРЕКТИВИ - (PL) DYREKTYWY - (AR) توجيه

LVD 2014/35/EU + Amdt.

EMC 2014/30/EU + Amdt.

RoHS 2011/65/EU + Amdt.

Pulse 
Tronic