

Kit 1001

AUDI 80/90, 4-dr Sedan, 87-91, 92-94

AUDI 4000, 4-dr Sedan, 87-91

AUDI 100/200, 4-dr Sedan, 83-90

480R
754

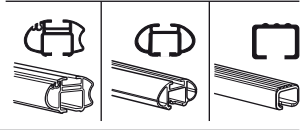
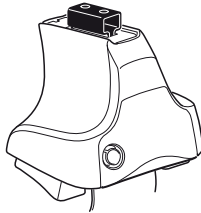

480

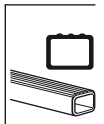
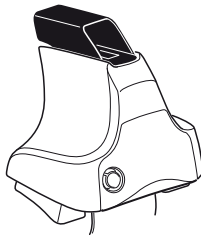

750

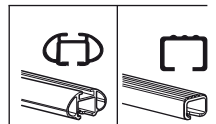
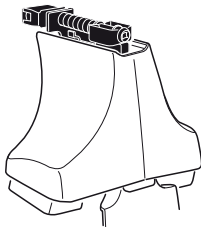

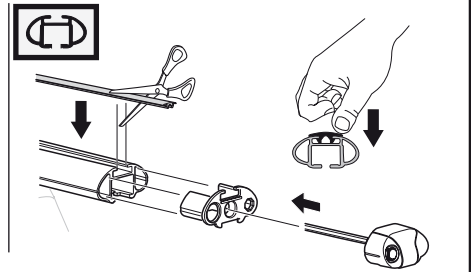
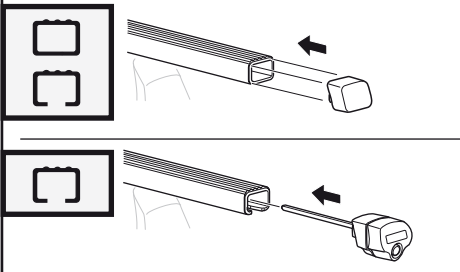
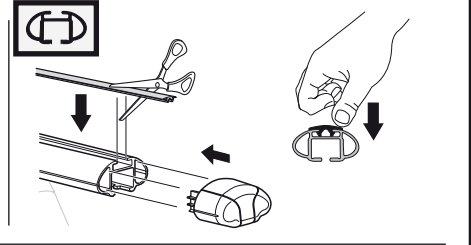
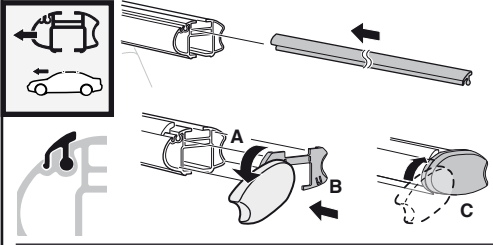
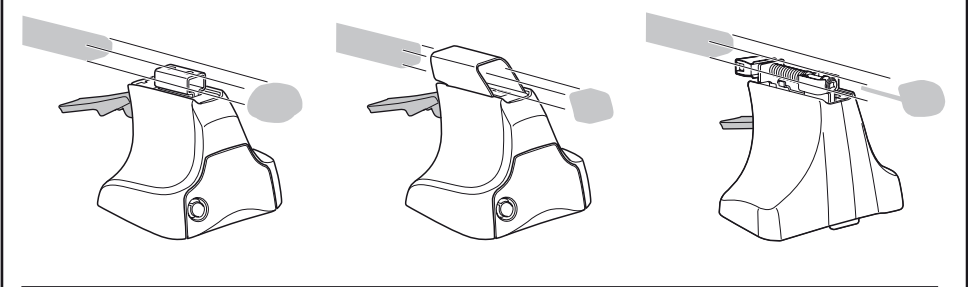
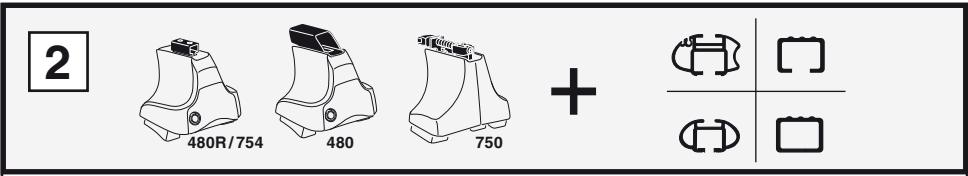
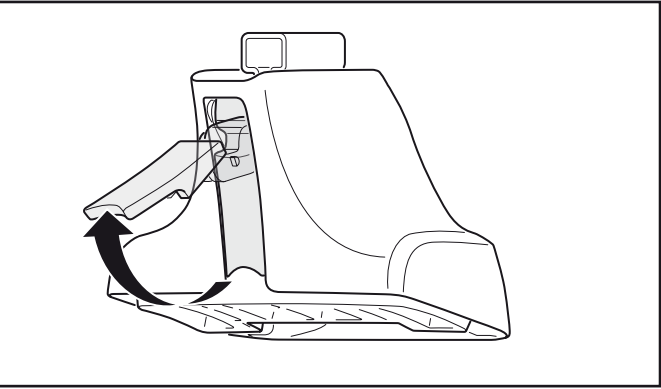
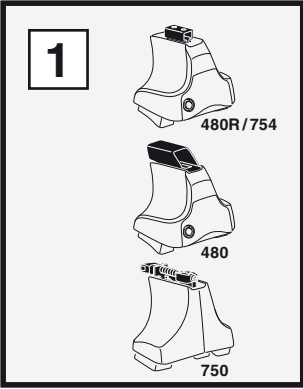

3

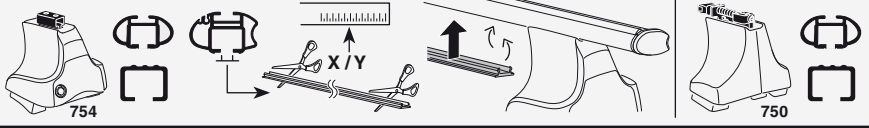

1

2

	X
AUDI 80/90, 4-dr Sedan, 87-91, 92-94	20,5
AUDI 4000, 4-dr Sedan, 87-91	20,5
AUDI 100/200, 4-dr Sedan, 83-90	29

1

2

	Y
AUDI 80/90, 4-dr Sedan, 87-91, 92-94	19
AUDI 4000, 4-dr Sedan, 87-91	19
AUDI 100/200, 4-dr Sedan, 83-90	27

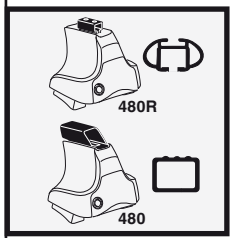

1

2

	X inch	X mm
AUDI 80/90, 4-dr Sedan, 87-91, 92-94	33 ³ / ₄ "	856 mm
AUDI 4000, 4-dr Sedan, 87-91	33 ³ / ₄ "	856 mm
AUDI 100/200, 4-dr Sedan, 83-90	37 "	941 mm

1

2

	Y inch	Y mm
AUDI 80/90, 4-dr Sedan, 87-91, 92-94	33 ¹ / ₈ "	841 mm
AUDI 4000, 4-dr Sedan, 87-91	33 ¹ / ₈ "	841 mm
AUDI 100/200, 4-dr Sedan, 83-90	36 ¹ / ₄ "	921 mm

4

AUDI 80/90, 4-dr Sedan, 87-91, 92-94

AUDI 4000, 4-dr Sedan, 87-91

AUDI 100/200, 4-dr Sedan, 83-90

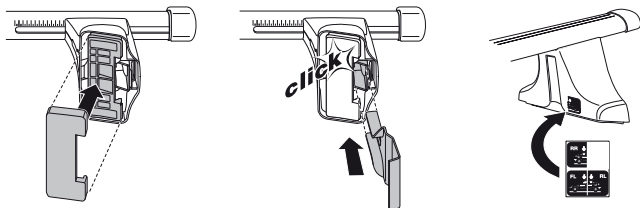
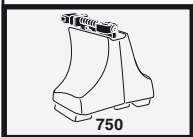
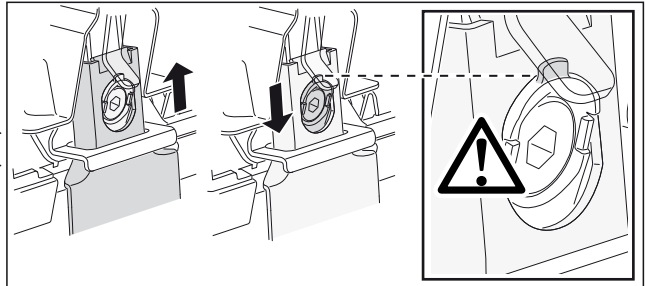
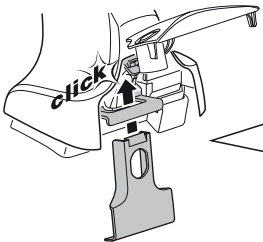
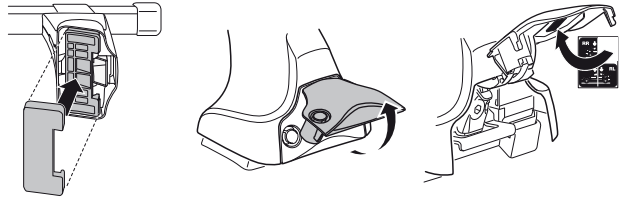
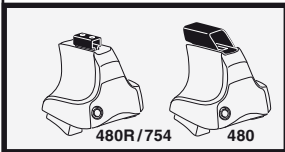
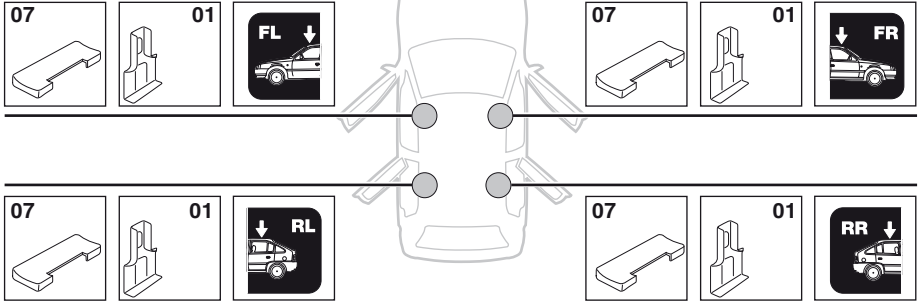

5

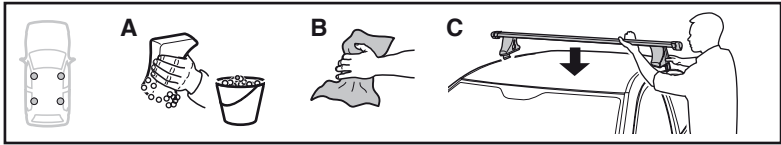

	X mm	Y mm	X inch	Y inch
AUDI 80/90 , 4-dr Sedan, 87-91, 92-94	270 mm	700 mm	10 ⁵ / ₈ "	27 ¹ / ₂ "
AUDI 4000 , 4-dr Sedan, 87-91	270 mm	700 mm	10 ⁵ / ₈ "	27 ¹ / ₂ "
AUDI 100/200 , 4-dr Sedan, 83-90	210 mm	700 mm	8 ¹ / ₄ "	27 ¹ / ₂ "

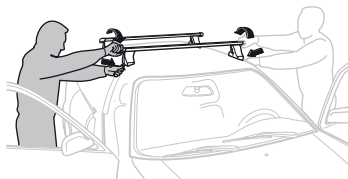
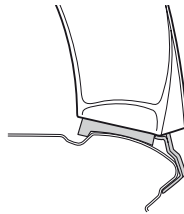
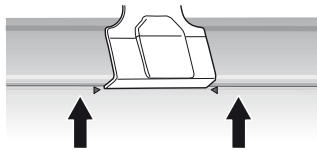
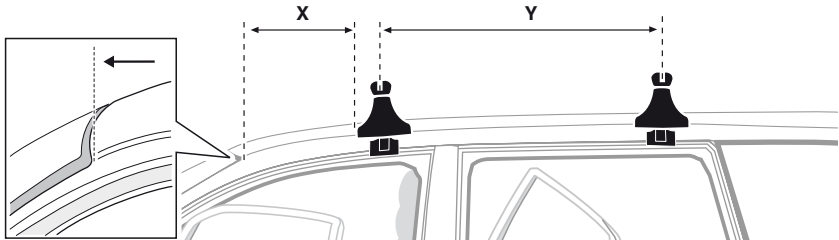

GB/US Tighten alternately

D Die Schrauben abwechselnd anziehen

F Serrer alternativement chaque côté

NL Afwisselend aan de linker- en de rechterkant aandraaien

I Alternare il serraggio delle viti

E Apretar alternativamente

PT Aperte alternadamente

S Dra åt växelvis

FIN Kierrä vuorotellen

EST Pinguldage vaheldumisi

LAT Pielvelciēt pamīšus

LIT Užsukinėkite pakaitomis

PL Śruby dokręcaj naprzemiennie

RU Затягивайте попеременно

CZ Pokręťta bagażníka dokręcaj dokręcaj naprzemiennie.

SK Doťahujte striedavo

SLO Privijajte izmenično.

HR Naizmjenično zategnite

HU Egymástól függetlenül szorítandó

GR Σφιγγετε εναλλάξ

TR Dönüşümlü sıkın

中文 交替拧紧

한국어 번갈아 가며 조이십시오.

日本語 交互に締め付けてください。

ไทย ชั้โน้แบบสลับ

6



480R/754



480

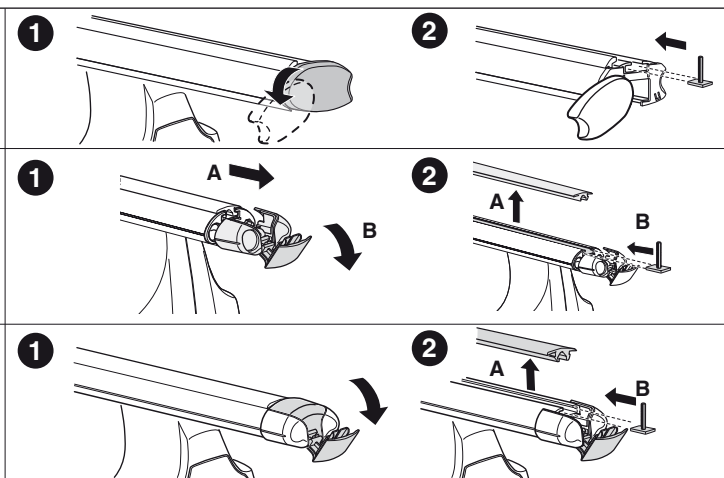
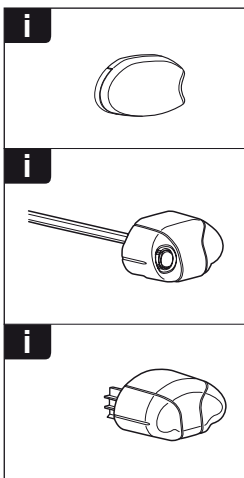
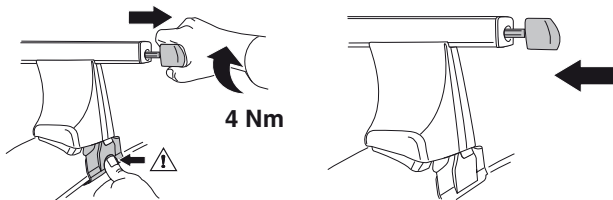
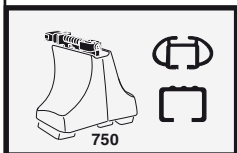
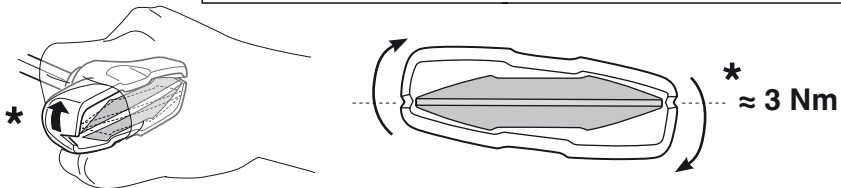
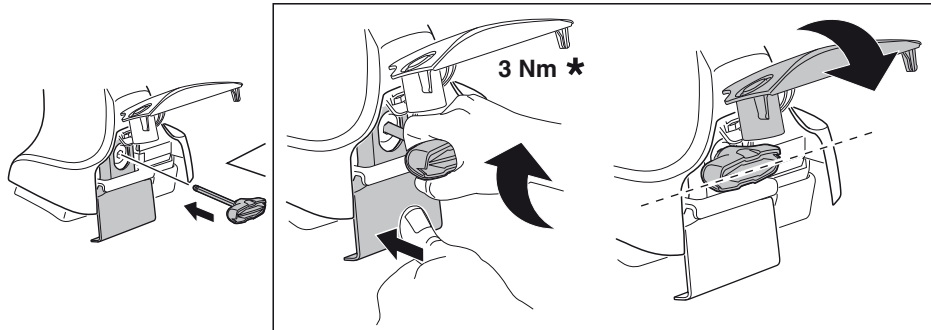

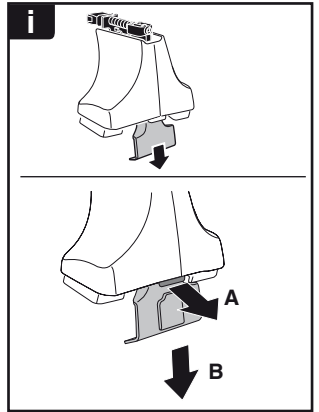
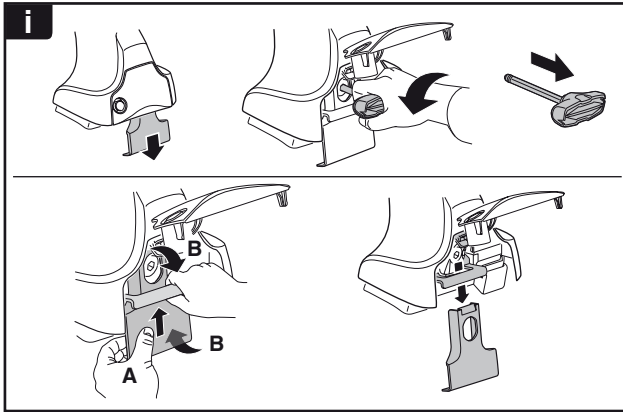
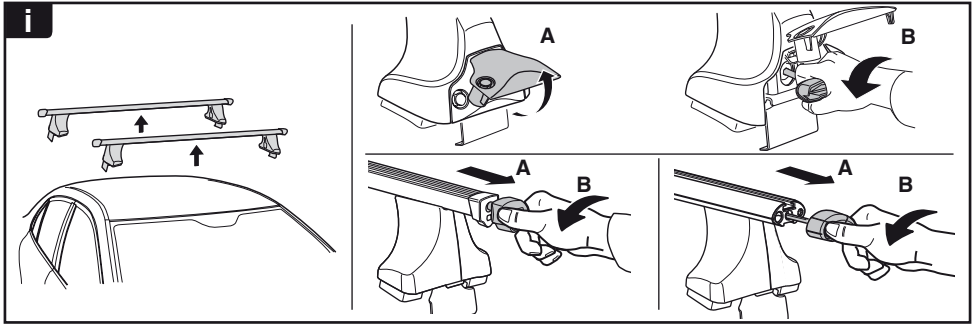

THULE
SWEDEN
**ONE
KEY
SYSTEM**

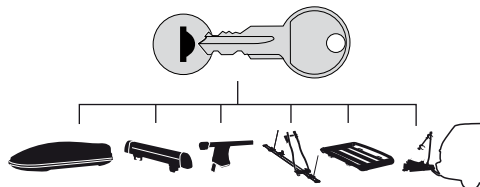

- 544 (x4)
- 596 (x6)
- 588 (x8)
- NA 510 (x10)
- EUR 452 (x12)
- ASIA 452 (x12)

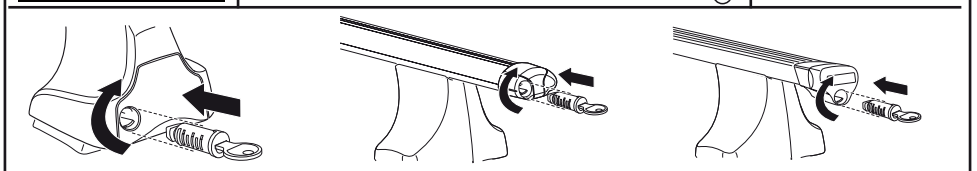

WW ▶ Thule Sweden AB, Box 69, 330 33 Hillerstorp, SWEDEN
NA ▶ Thule Inc., 42 Silvermine Road, Seymour, Connecticut 06483, USA

info@thule.com
customer.service@thule.com

www.thule.com