

SPARE PARTS LIST

MODEL NO. UC4030A

ITEM	PART NO.	DESCRIPTION	QTY	NOTE
001	226743-8	STRAIGHT BEVEL GEAR 14	1	
002	419410-4	BAFFLE PLATE	1	
003	211111-8	BALL BEARING 6301LLB	1	
004	240001-8	FAN 80	1	
005	616969-4	ARMATURE 240V	1	
006	681666-1	RESIN WASHER	1	
007	211057-8	BALL BEARING 629ZZ	1	
008	639530-0	FIELD 240V	1	
009	266095-5	TAPPING SCREW 5X55	2	
010	265995-6	TAPPING SCREW 4X18	1	
011	188818-0	HANDLE SET INC. 28	1	
012	654532-5	TERMINAL BLOCK 1P	1	
013	867113-8	UC4030A NAME PLATE	1	
014	650577-1	SWITCH SD-006-BB2AA-AA	1	
015	631719-6	CONTROLLER	1	
016	682574-9	CORD GUARD 10-90	1	
017	665894-6	POWER SUPPLY CORD 1.0-2-0.5	1	
018	687124-5	STRAIN RELIEF	1	
019	265995-6	TAPPING SCREW 4X18	2	
020	416178-3	LOCK-OFF BUTTON	1	
021	233173-6	COMPRESSION SPRING 4	1	
022	419411-2	SWITCH LEVER	1	
023	645239-4	NOISE SUPPRESSOR	1	
024	651923-1	SWITCH TG70B	1	
025	643650-4	BRUSH HOLDER CAP 6.5-13.5	2	
026	181044-0	CARBON BRUSH CB-153	1	
027	154867-9	MOTOR HOUSING COMPLETE	1	
028	188818-0	HANDLE SET INC. 11	1	
029	265995-6	TAPPING SCREW 4X18	1	
030	265995-6	TAPPING SCREW 4X18	5	
032	154870-0	TANK CAP COMPLETE	1	
033	419412-0	GEAR HOUSING COVER	1	
034	140089-7	OIL PUMP COMPLETE	1	
035	213039-6	O RING 6	1	
036	421959-2	SPONGE SEAL	1	
037	419407-3	OIL TANK	1	
038	416274-7	CAP	1	
039	231975-4	SPRING	1	
040	421958-4	OIL TUBE	1	
041	419408-1	GEAR HOUSING	1	
042	419413-8	ROD	1	
043	233174-4	COMPRESSION SPRING 6	1	
044	451130-4	FRONT HAND GUARD	1	
045	158044-5	LINK PLATE COMPLETE	1	
046	234005-0	COMPRESSION SPRING 9	1	
047	213039-6	O RING 6	1	
048	211012-0	BALL BEARING 606ZZ	1	
049	450230-7	CRANK	1	
050	417405-1	CAM	1	
051	259034-2	RETAINING RING E TYPE 10	1	
052	266095-5	TAPPING SCREW 5X55	2	
053	266173-1	TAPPING SCREW 5X30	4	
054	226741-2	STRAIGHT BEVEL GEAR 43	1	
055	324662-3	SPINDLE	1	
056	211107-9	BALL BEARING 6201ZZ	1	
057	419409-9	FRONT HANDLE	1	
058	266173-1	TAPPING SCREW 5X30	2	
059	921452-1	HEX. BOLT M8X30	1	
060	318013-0	BEARING HOUSING	1	

SPARE PARTS LIST

MODEL NO. UC4030A

ITEM	PART NO.	DESCRIPTION	QTY	NOTE
063	345651-5	SPIKE BUMPER	1	
064	266173-1	TAPPING SCREW 5X30	2	
065	168426-3	BRAKE BAND	1	
066	267195-4	FLAT WASHER 4	1	
067	266026-4	TAPPING SCREW BIND CT 4X12	1	
068	125331-7	BRAKE DRUM ASSEMBLY	1	
069	253215-0	FLAT WASHER 8	1	
070	259033-4	RETAINING RING E TYPE 6	1	
071	266007-8	TAPPING SCREW BIND PT 3X10	1	
072	419241-1	COVER	1	
073	227496-2	STRAIGHT BEVEL GEAR 14	1	
074	227495-4	STRAIGHT BEVEL GEAR 14	1	
075	154869-5	SPROCKET COVER COMPLETE	1	
076	419233-0	DIAL 40	1	
077	253874-0	FLAT WASHER 4	1	
078	915106-0	BINDING HEAD SCREW M4X8	1	
079	233033-2	COMPRESSION SPRING 4	1	
080	216008-6	STEEL BALL 4	1	
081	154763-1	LEVER COMPLETE	1	
082	951122-8	SPRING PIN 4-28	1	
083	419271-2	CUP WASHER 20	1	
084	317977-5	LEVER HOLDER	1	
085	231025-5	COMPRESSION SPRING 8	1	
086	252168-0	HEX. NUT M8-13	1	
087	324621-7	ADJUST PIN	1	
088	324620-9	ADJUST SCREW	1	
089	188858-8	SPROCKET COVER SET INC. 71-88	1	
090	188859-6	LEVER COMPLETE SET INC. 81-84	1	
091	188929-1	OIL PUMP COMPLETE SET INC. 34,35,49	1	
A01	419560-5	CHAIN COVER	1	
A02	158024-1	HOOK COMPLETE	1	
A03	165202-6	GUIDE BAR 16"	1	
A04	837010-2	OIL ABSORBENT SHEET	1	
A05	528092656	SAW CHAIN 16"	1	

SERVICE DRAWING

MODEL NO. UC4030A

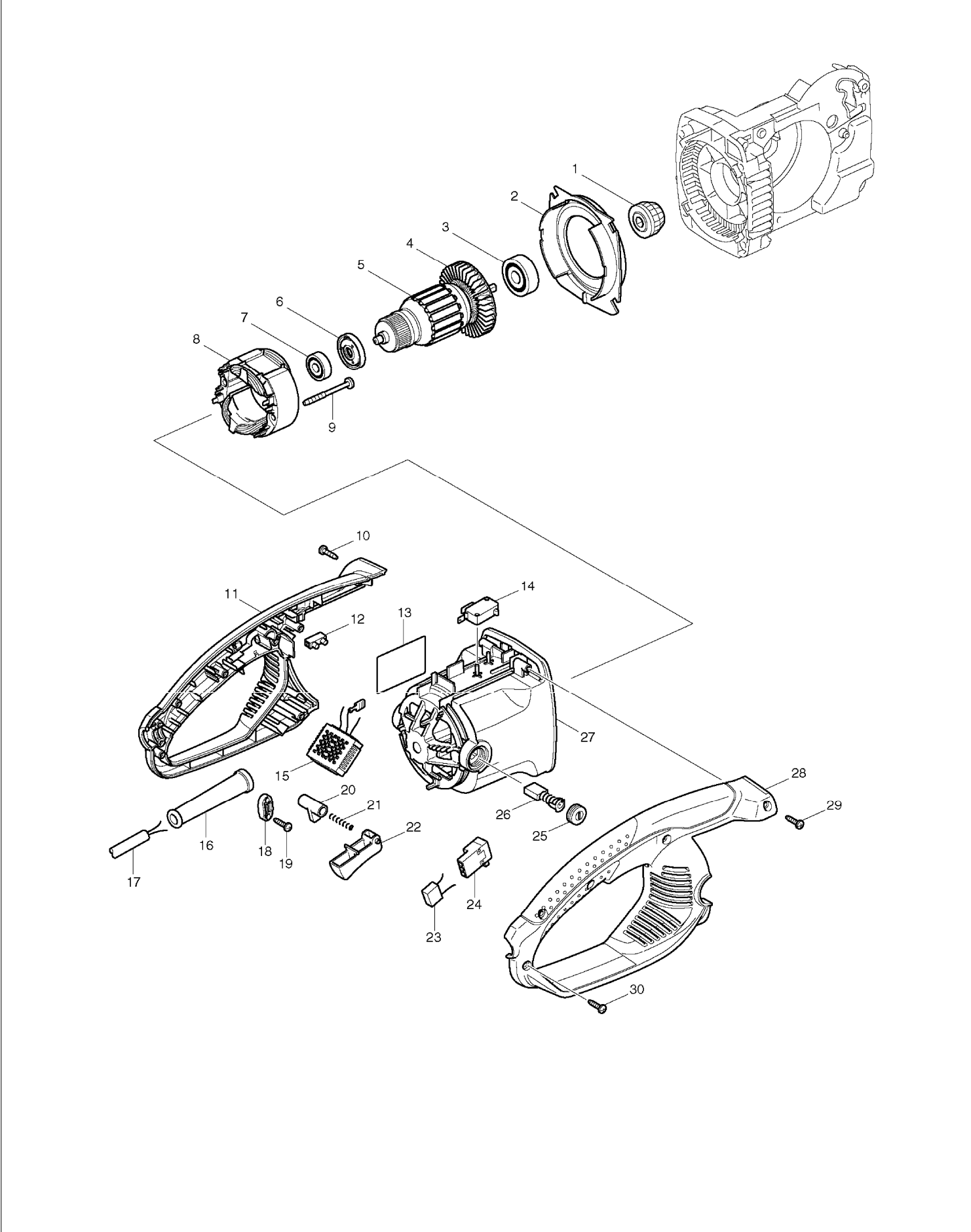

SERVICE DRAWING

MODEL NO. UC4030A

