

Kit 3087

VOLKSWAGEN Amarok, 2-dr Single Cab, 10-
VOLKSWAGEN Amarok, 4-dr Double Cab, 10-

This Kit is only for vehicles with fixpoint mounting.

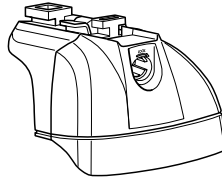

460R
753

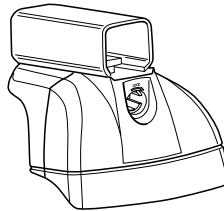
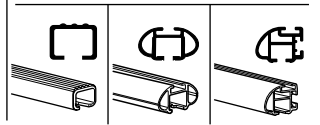

460

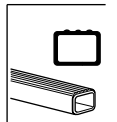

- 21 x 1
- 22 x 1
- 23 x 2
- 17 x 4
- 005 x 1
- 006 x 1
- 013 x 1
- 014 x 1
- 50784 x 4
- 50786 x 4
- 50870 x 4
- 51294 3mm x 1
- 50273 x 1

Kit

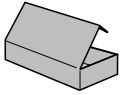

753

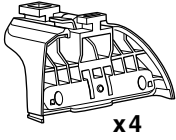

x4



x4



x4



x8

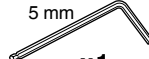

x1



x4



x1

460R

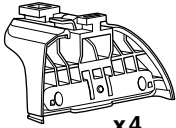

x4



x4



x4



x8

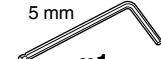

x1



x4

460

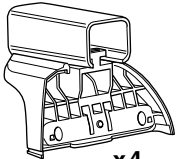

x4



x4



x4



x8

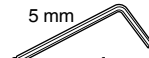

x1



x4

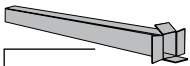

x2



x1



x2



x2



x2



x1

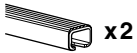

x2

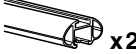

x2

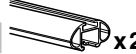

x2

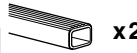

x2



x2

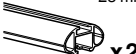

x2



x4

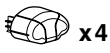

x4



x4

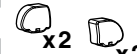

x2



x2

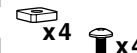

x4



x4



x1

5 mm

1

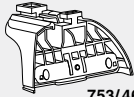

753/460R

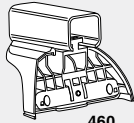

460

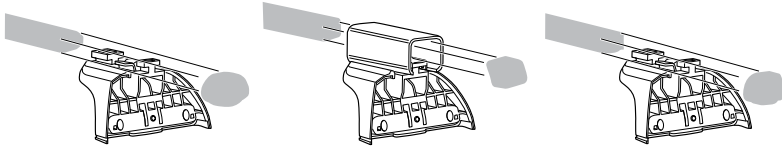

x4

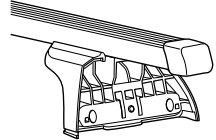
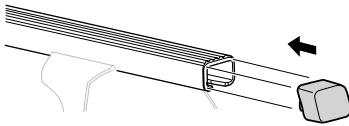

x4

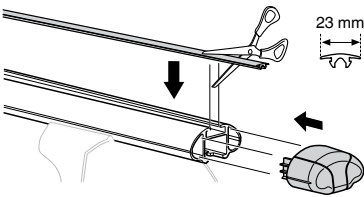

23 mm

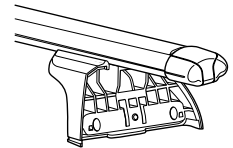
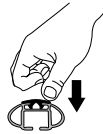

x4

x4

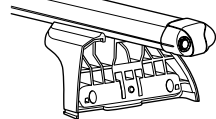
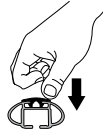
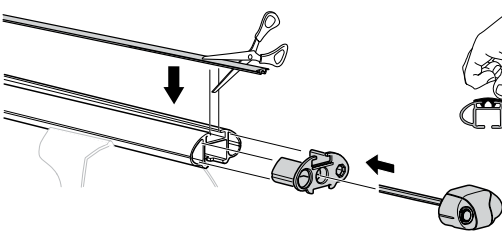

x4

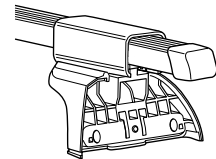
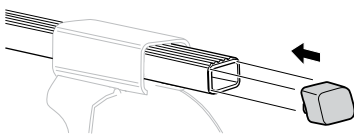

x2

x2

x4

x4

x1
5 mm

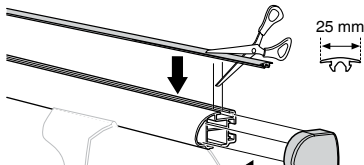

25 mm

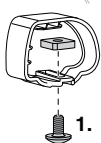
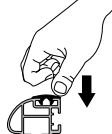

1.

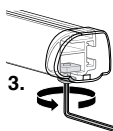

3.

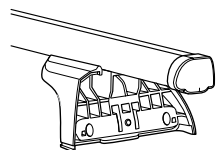

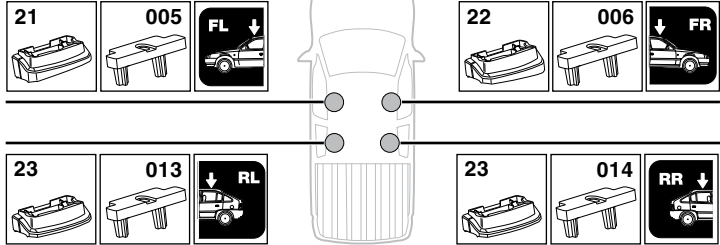
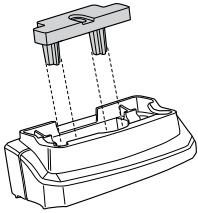
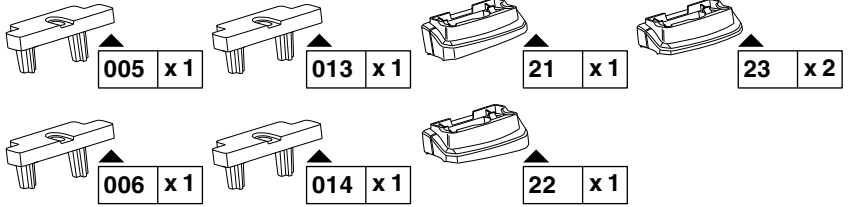
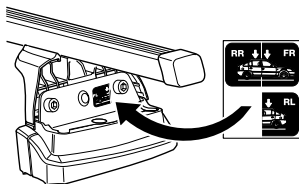
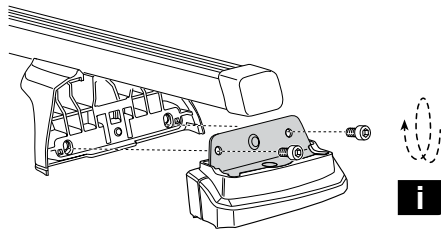
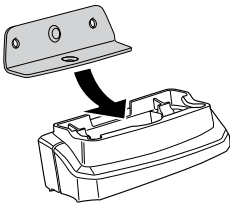
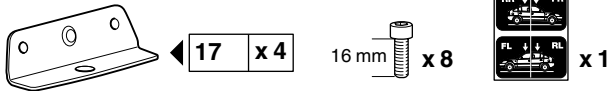
2**3****i**

- | | | | |
|------------|---------------------------|------------|--------------------------------|
| GB | Only a few turns | RU | Достаточно нескольких оборотов |
| D | Nur wenige Umdrehungen | CZ | Pouze několik otáček |
| F | Quelques tours uniquement | SK | Len niekoľko otáčok |
| NL | Slechts enkele slagen | SLO | Le nekaj obratov |
| I | Solo qualche giro | HR | Samo nekoliko okreta |
| E | Sólo algunas vueltas | HU | Csak néhány fordítás |
| PT | Noções básicas | GR | Μόνο μερικές στροφές |
| S | Endast några varv | TR | Yalnız birkaç kez çevirm |
| FIN | Vain muutama kierros | 中文 | 只有几个转向 |
| EST | Ainult mõni pööre | 한국어 | 두 세번만 |
| LAT | Tikai dažī apgriezieni | 日本語 | 数回転のみ |
| LIT | Tik keli pasukimai | ไทย | หมุนเพียงไม่กี่รอบ |
| PL | Wystarczy kilka obrotów | | |

4

x 4

x 4

x 4

x 1

3 mm

x 1

5 mm

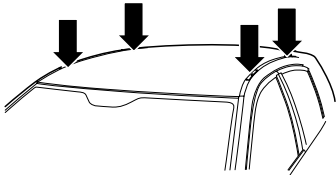
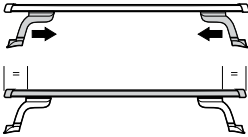
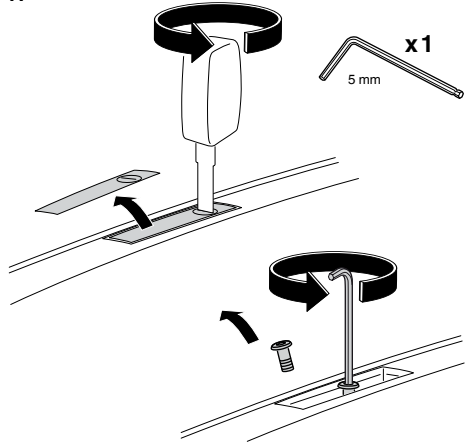
**A**

x 1

5 mm

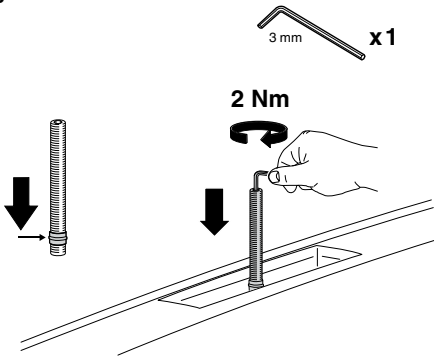
B

3 mm

x 1

2 Nm

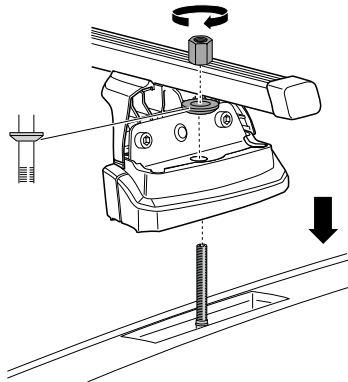
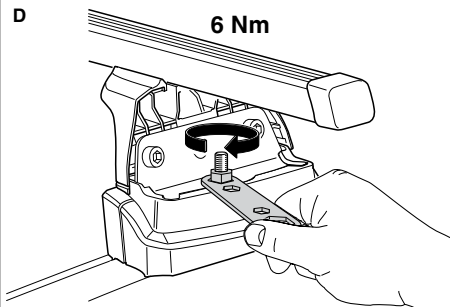
C**D**

6 Nm

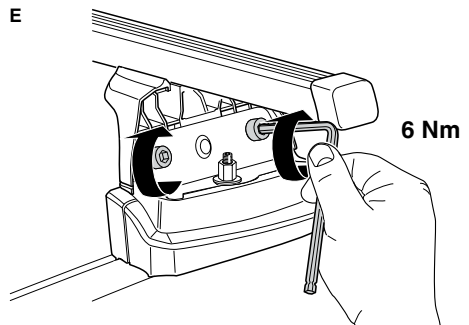
E

6 Nm

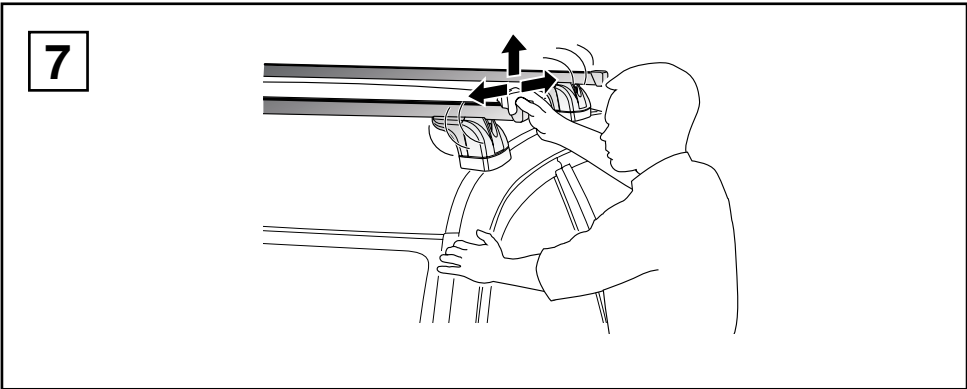
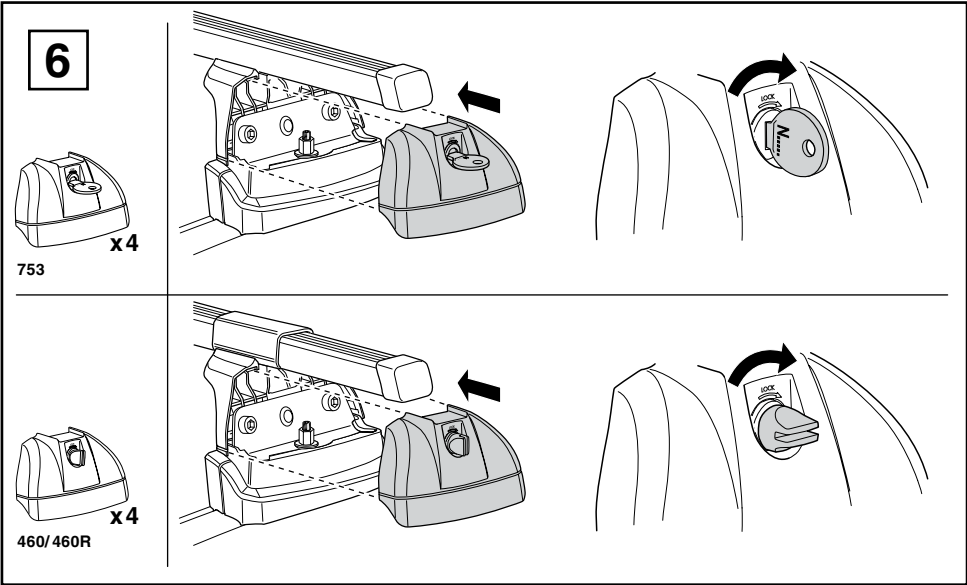
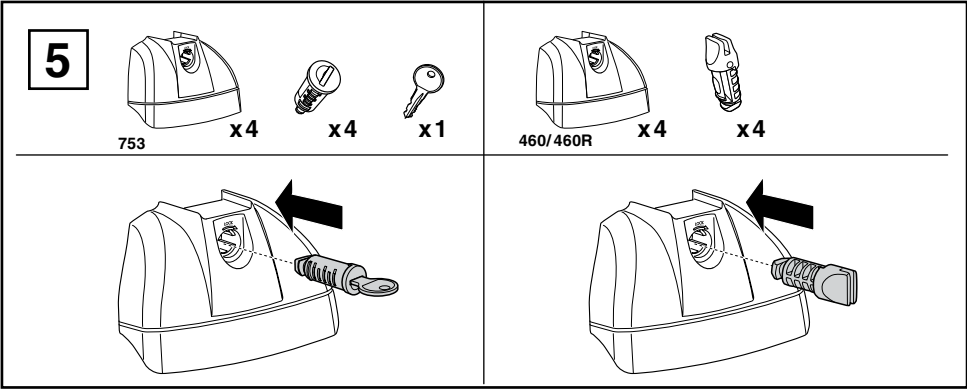

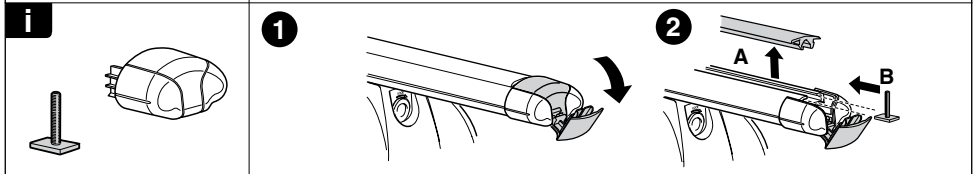
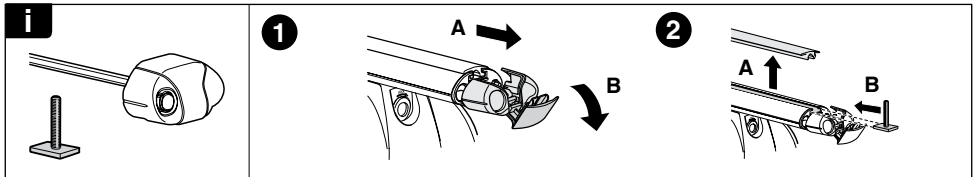
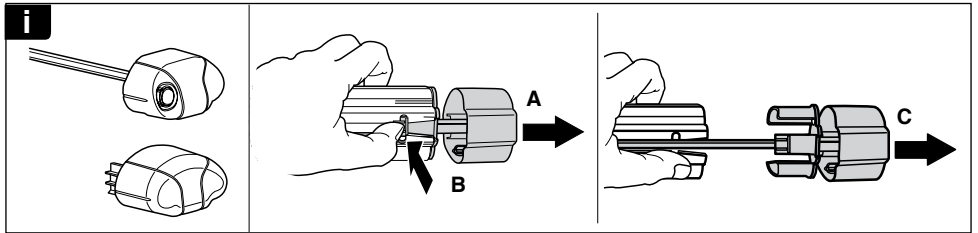
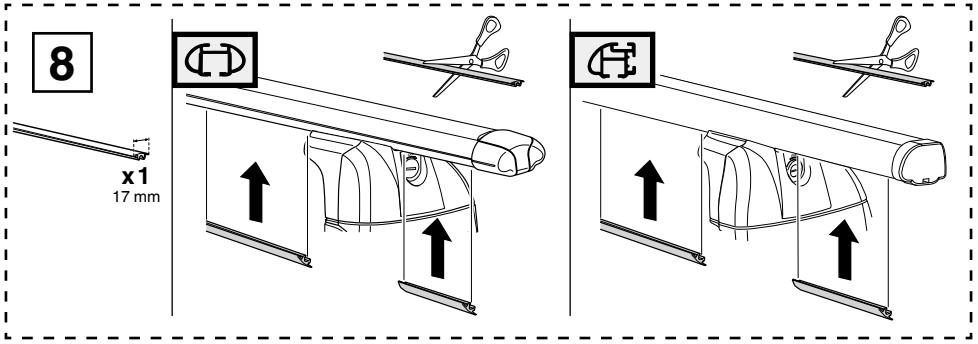

THULE
SWEDEN

**ONE
KEY
SYSTEM**

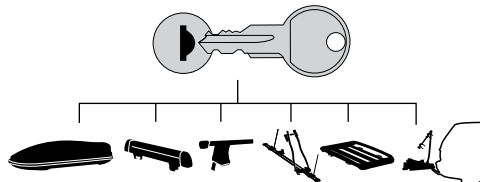

544 (x4)

596 (x6)

588 (x8)

NA 510 (x10)

EUR 452 (x12)

WW ▶ Thule Sweden AB, Box 69, 330 33 Hillerstorp, SWEDEN

NA ▶ Thule Inc., 42 Silvermine Road, Seymour, Connecticut 06483, USA

@ info@thule.com
customer.service@thule.com

www.thule.com

506-3087-02