

Kit 1632

PORSCHE Cayenne, 5-dr SUV, 10- / *11- (Without railing)

*North America

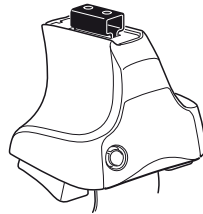

754 Rapid System
480R Rapid Traverse (North America)

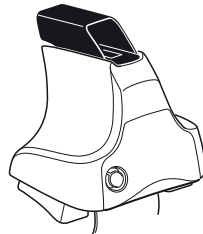
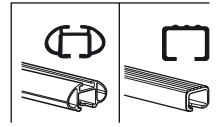

480 Traverse (North America)

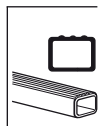

1

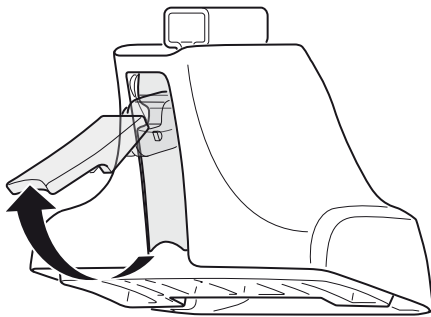

2



754 Rapid System
480R Rapid Traverse
(North America)

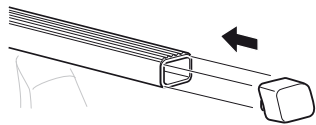
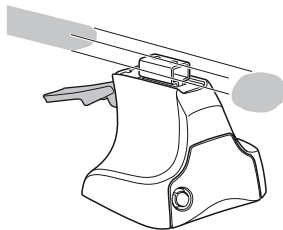

x4

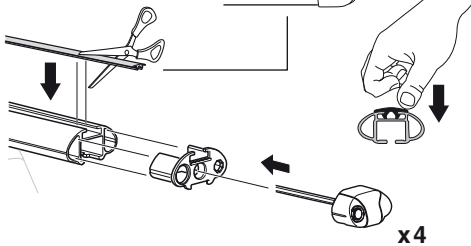
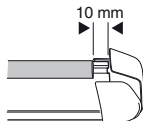

x4

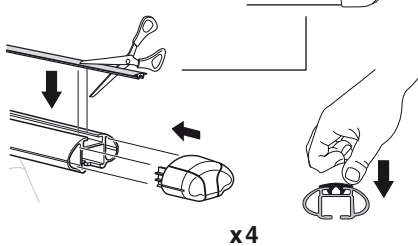
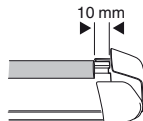

x4



480 Traverse
(North America)

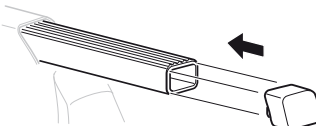
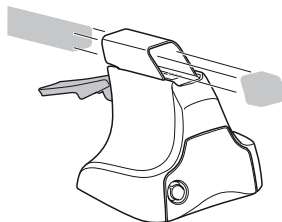

x4

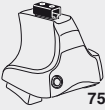
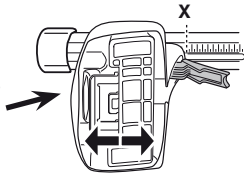
3**754** Rapid System

	X
PORSCHE Cayenne, 5-dr SUV, 10- / *11- (Without railing)	51

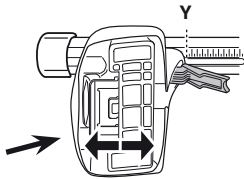

	Y
PORSCHE Cayenne, 5-dr SUV, 10- / *11- (Without railing)	45

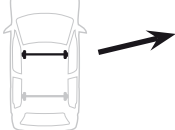
3**480R** Rapid Traverse**480** Traverse**(North America)**

	X inch	X mm
PORSCHE Cayenne, 5-dr SUV, 10- / *11- (Without railing)	45 ³/₄"	1161 mm

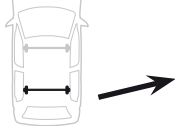

	Y inch	Y mm
PORSCHE Cayenne, 5-dr SUV, 10- / *11- (Without railing)	43 ³/₈"	1101 mm

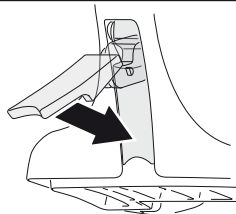
4

5

PORSCHE Cayenne, 5-dr SUV, 10- / *11- (Without railing)

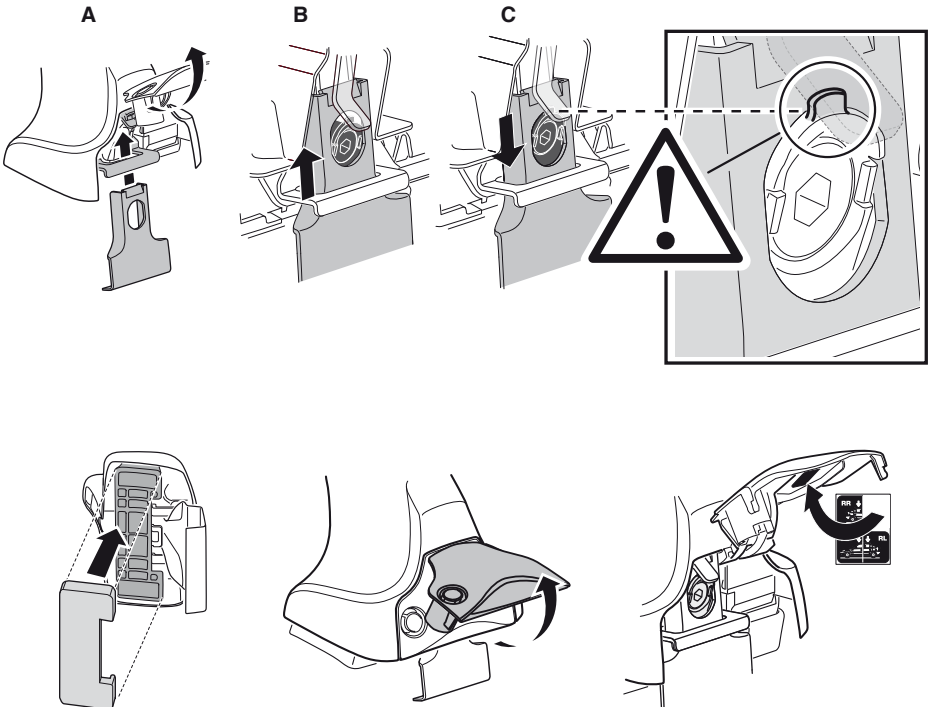
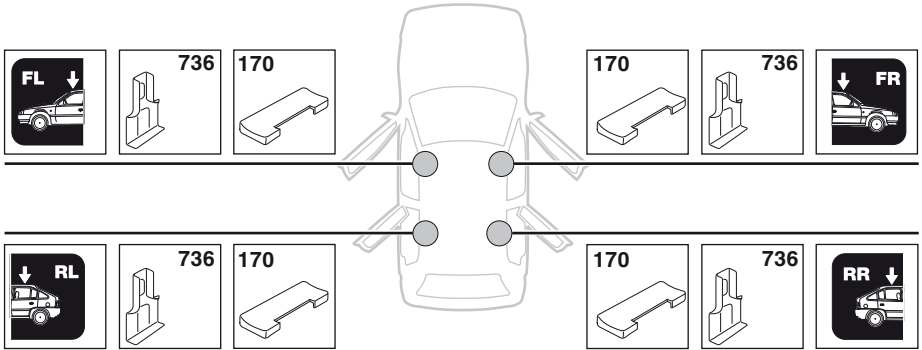

6

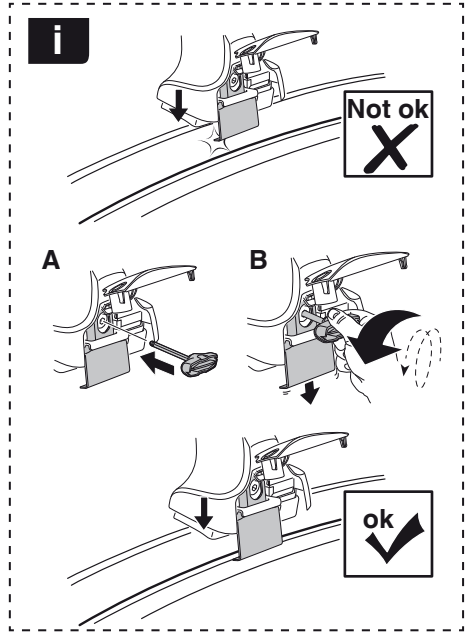
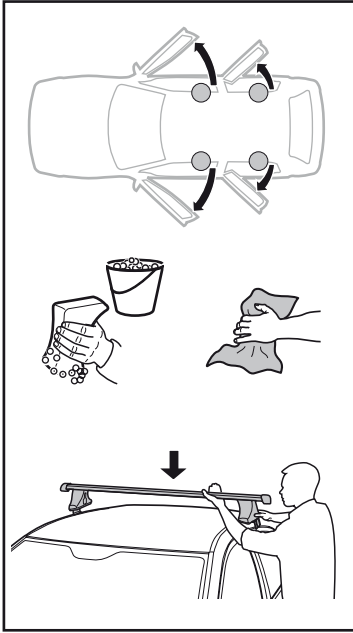

	X mm	Y mm	X inch	Y inch
PORSCHE Cayenne, 5-dr SUV, 10- / *11- (Without railing)	400 mm	700 mm	15 3/4"	27 1/2"

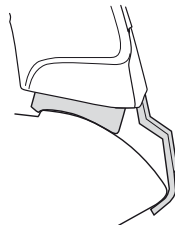
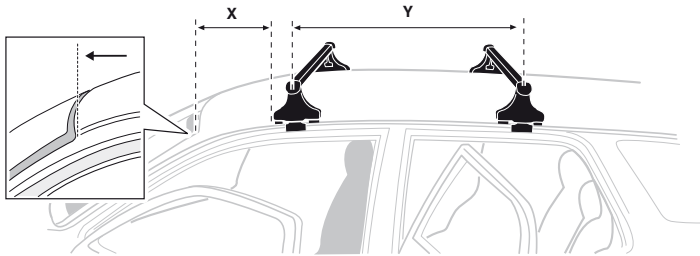

7

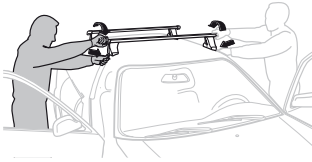

GB/US Tighten alternately
 D Die Schrauben abwechselnd anziehen
 F Serrer alternativement chaque côté
 NL Afwisselend aan de linker- en de rechterkant aandraaien
 I Alternare il serraggio delle viti
 E Apretar alternativamente
 PT Aperte alternadamente
 S Dra åt växelvis
 FIN Kierrä vuorotellen
 EST Pinguldage vaheldumisi
 LAT Pieļieciet pamišus
 LIT Užsukinėkite pakaitomis
 PL Śruby dokręcaj naprzemiennie
 RU Затягивайте попеременно

CZ Pokręťta bagażnika dokręcaj dokręcaj naprzemiennie.
 SK Dofahajte striedavo
 SLO Privijajte izmenično.
 HR Naizmjerno zategnite
 HU Egymástól függetlenül szorítandó
 GR Σφιγγείτε εναλλάξ
 TR Dönüşümlü sıkın

中文 交替拧紧

한국어 번갈아 가며 조이십시오.

日本語 交互に締め付けてください。

ไทย ชันในแบบสลับ

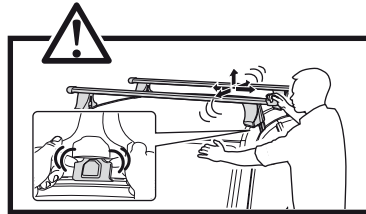
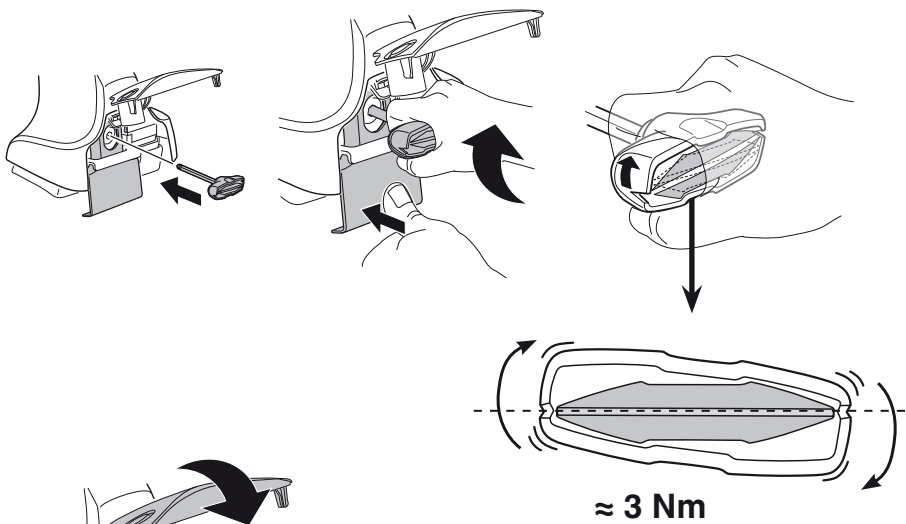

8



x1
17 mm

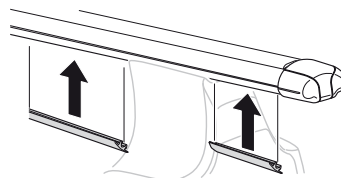
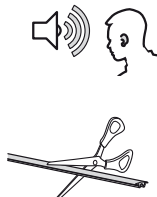

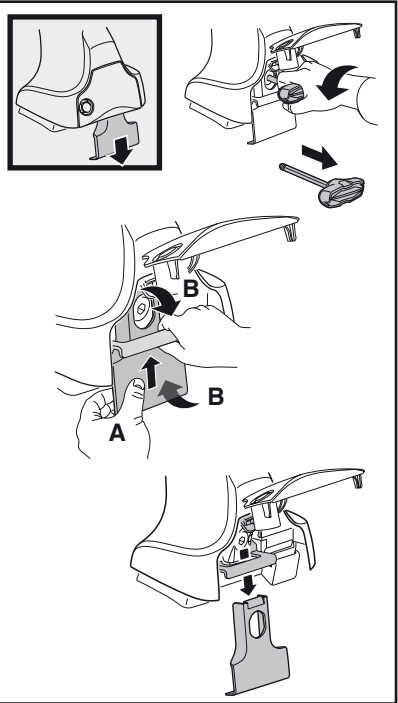
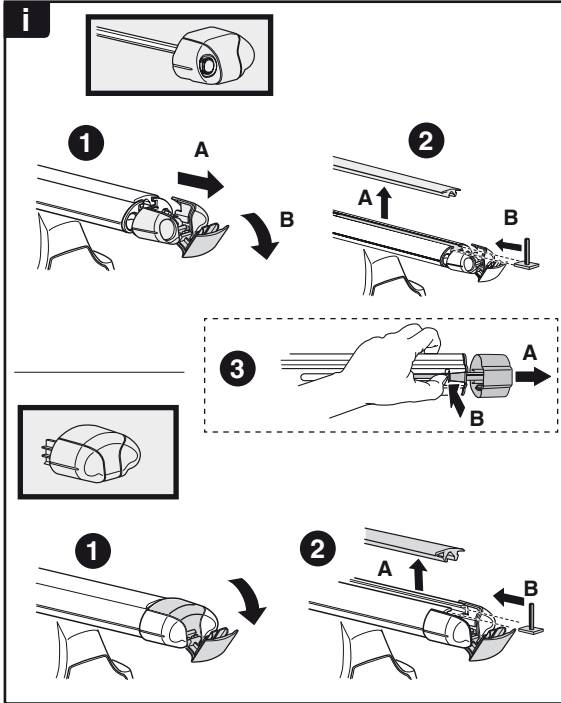
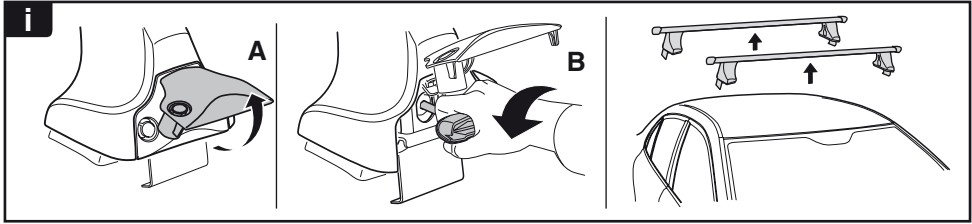

THULE
SWEDEN
**ONE
KEY
SYSTEM**

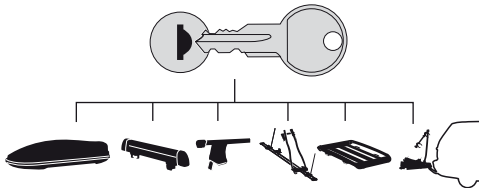

- 544** (x4)
- 596** (x6)
- 588** (x8)
- NA **510** (x10)
- EUR **452** (x12)
- ASIA

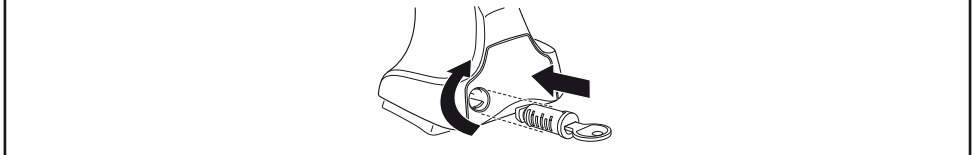

WW ▶ Thule Sweden AB, Box 69, 330 33 Hillerstorp, SWEDEN
NA ▶ Thule Inc., 42 Silvermine Road, Seymour, Connecticut 06483, USA

info@thule.com
customer.service@thule.com

www.thule.com