

Kit 1538

NISSAN Maxima, 4-dr Sedan, 04-08 (NA)

NISSAN Sentra, 4-dr Sedan, 07- (NA)

480R
754

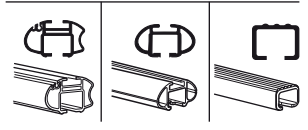
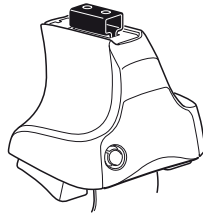

480

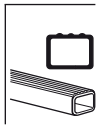
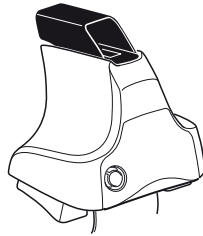

750

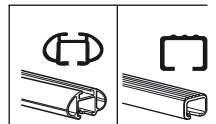
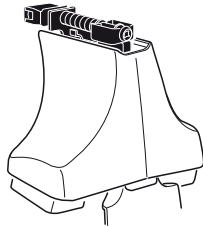

x2 x2 x2 x4	x2	x2 x2 x4 x4	x2 x2	x2

791 x 2

916 x 2

04 x 2

19 x 2

43 x 2

x 1

Kit



3

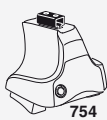

754

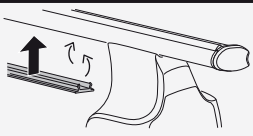
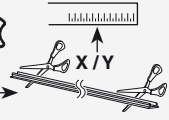

750

1

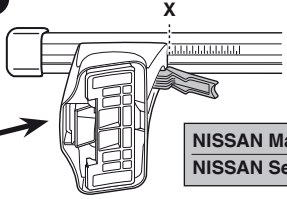
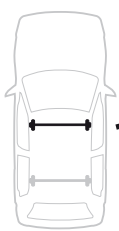

2

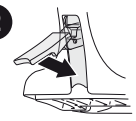

	X
NISSAN Maxima, 4-dr Sedan, 04-08 (NA)	40
NISSAN Sentra, 4-dr Sedan, 07- (NA)	35,5

1

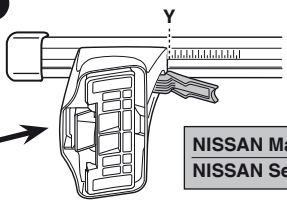

2

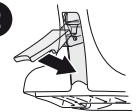

	Y
NISSAN Maxima, 4-dr Sedan, 04-08 (NA)	35,5
NISSAN Sentra, 4-dr Sedan, 07- (NA)	38,5



480R



480

1

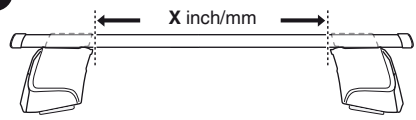

2



	X inch	X mm
NISSAN Maxima, 4-dr Sedan, 04-08 (NA)	41 ³ / ₈ "	1051 mm
NISSAN Sentra, 4-dr Sedan, 07- (NA)	39 ⁵ / ₈ "	1006 mm

1

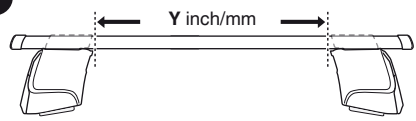

2



	Y inch	Y mm
NISSAN Maxima, 4-dr Sedan, 04-08 (NA)	39 ⁵ / ₈ "	1006 mm
NISSAN Sentra, 4-dr Sedan, 07- (NA)	40 ³ / ₄ "	1036 mm

4

NISSAN Maxima, 4-dr Sedan, 04-08 (NA)

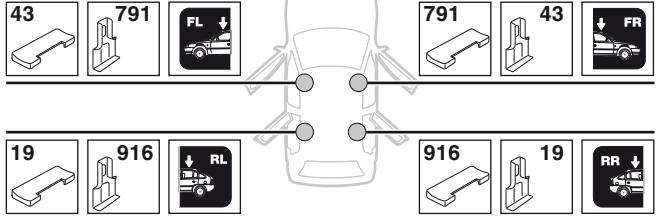

NISSAN Sentra, 4-dr Sedan, 07- (NA)

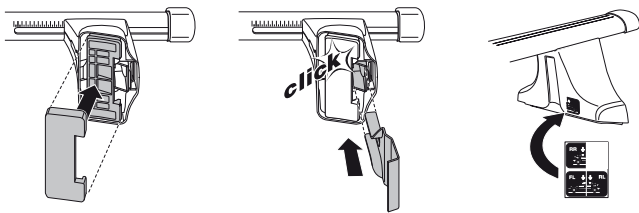
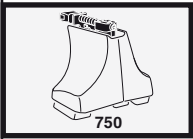
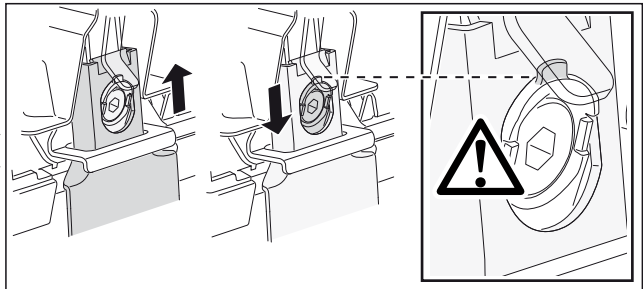
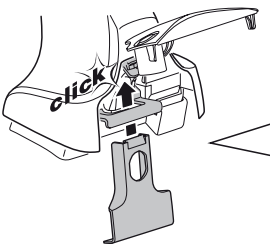
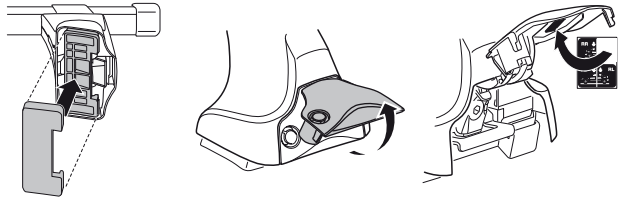
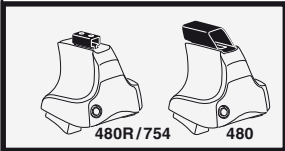
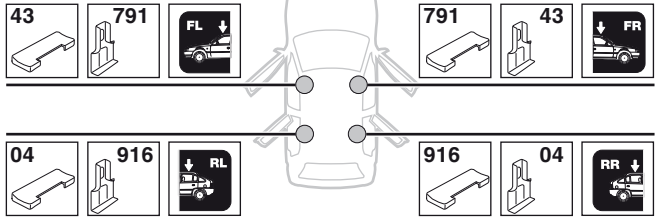

5



	X mm	Y mm	X inch	Y inch
NISSAN Maxima, 4-dr Sedan, 04-08 (NA)	255 mm	685 mm	10"	27"
NISSAN Sentra, 4-dr Sedan, 07- (NA)	255 mm	685 mm	10"	27"

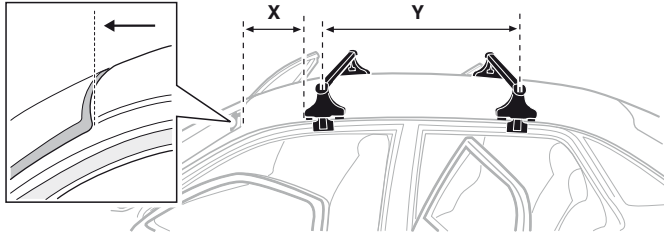

NISSAN Maxima, 4-dr Sedan, 04-08 (NA)

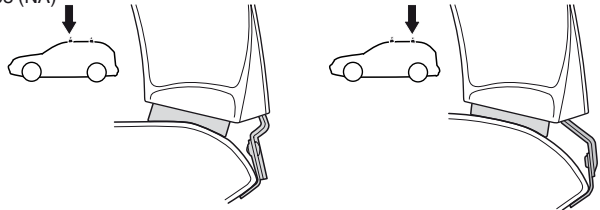

NISSAN Sentra, 4-dr Sedan, 07- (NA)

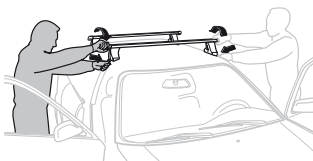
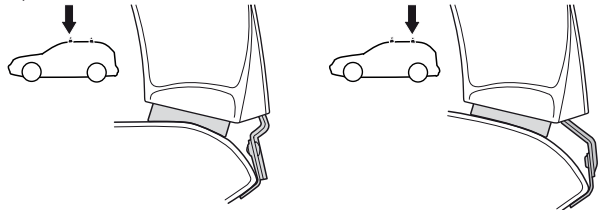

- GB/US** Tighten alternately
D Die Schrauben abwechselnd anziehen
F Serrer alternativement chaque côté
NL Afwisselend aan de linker- en de rechterkant aandraaien
I Alternare il serraggio delle viti
E Apretar alternativamente
PT Aperte alternadamente
S Dra åt växelvis
FIN Kierrä vuorotellen
EST Pinguldage vaheldumisi
LAT Pievelciet pamišus
LIT Užukinėkite pakaitomis
PL Śruby dokręcaj naprzemiennie
RU Затягивайте попеременно

- CZ** Pokrétla багаžníka dokręcaj naprzemiennie.
SK Dofahujte striedavo
SLO Privijajte izmenično.
HR Naizmjenično zategnite
HU Egymástól függetlenül szorítandó
GR Σφιγγετε εναλλάξ
TR Dönüşümlü sıkın

中文 交替拧紧

한국어 번갈아 가며 조이십시오.

日本語 交互に締め付けてください。

ไทย ขั้วในแบบสลับ

6



480R/754



480

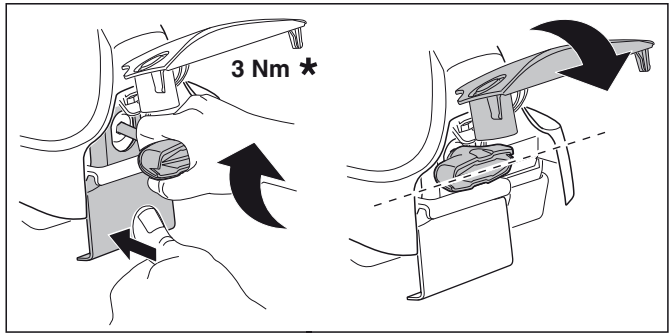

3 Nm *

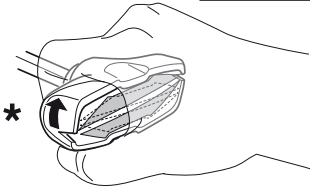

*

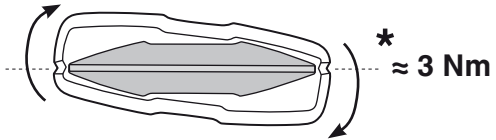

* ≈ 3 Nm



750

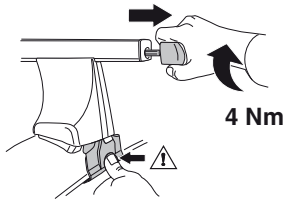

4 Nm

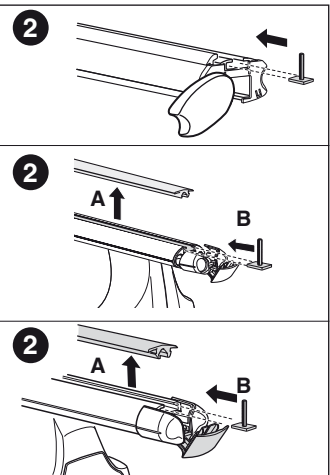
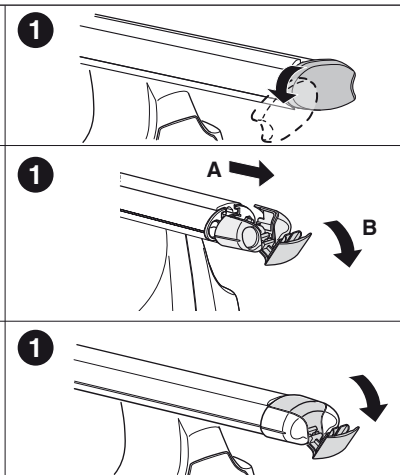
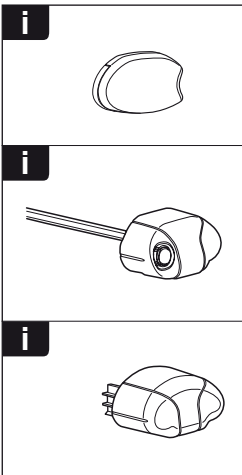
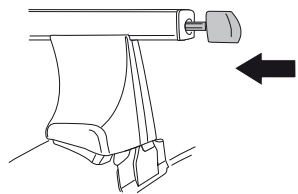

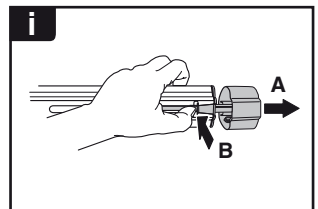
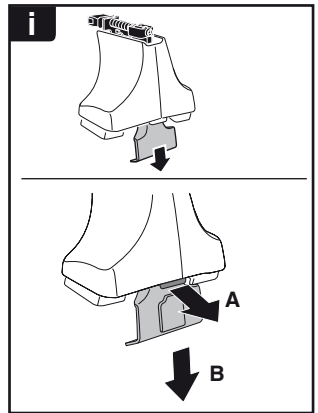
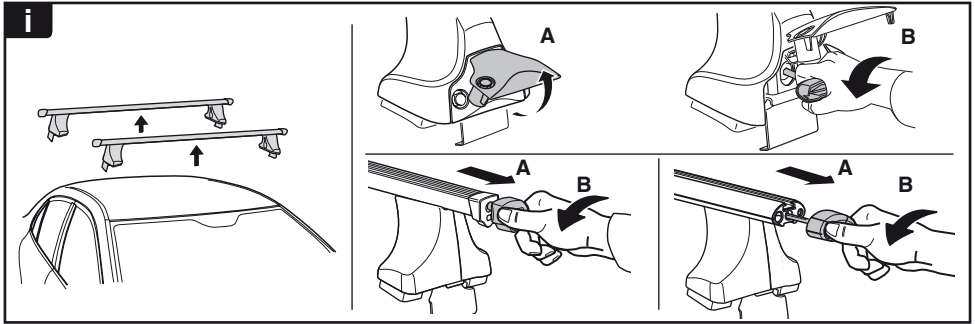

THULE
SWEDEN
**ONE
KEY
SYSTEM**



- 544 (x4)
- 596 (x6)
- 588 (x8)
- NA 510 (x10)
- EUR 452 (x12)
- ASIA



WW ▶ Thule Sweden AB, Box 69, 330 33 Hillerstorp, SWEDEN
NA ▶ Thule Inc., 42 Silvermine Road, Seymour, Connecticut 06483, USA

info@thule.com
customer.service@thule.com

www.thule.com