

Kit 1386

NISSAN Tiida Latio, 4-dr Sedan, 04- (JPN)

NISSAN Versa, 4-dr Sedan, *07-10

*North America

480R
754

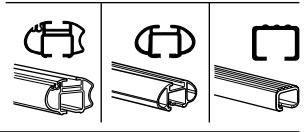
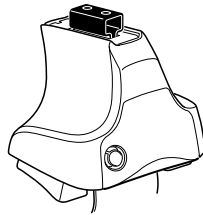

480

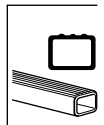
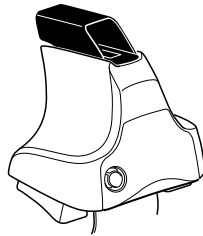

750

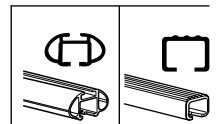
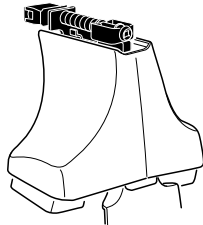

Kit



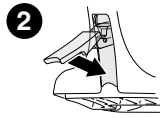
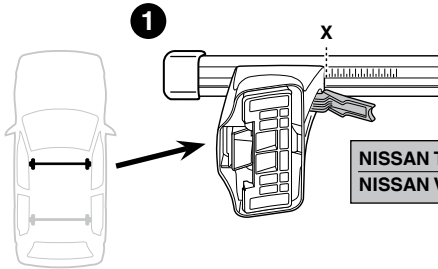

	X
NISSAN Tiida Latio, 4-dr Sedan, 04- (JPN)	36
NISSAN Versa, 4-dr Sedan, *07-10	36

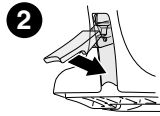
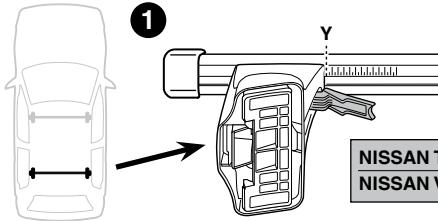

	Y
NISSAN Tiida Latio, 4-dr Sedan, 04- (JPN)	35
NISSAN Versa, 4-dr Sedan, *07-10	35

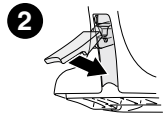
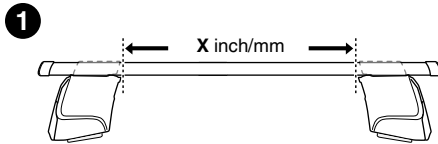
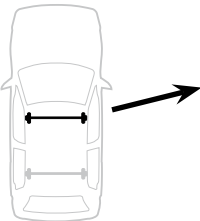

	X inch	X mm
NISSAN Tiida Latio, 4-dr Sedan, 04- (JPN)	39 3/4"	1011 mm
NISSAN Versa, 4-dr Sedan, *07-10	39 3/4"	1011 mm

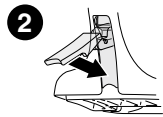
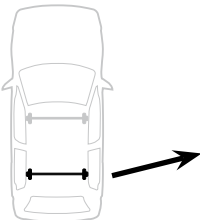

	Y inch	Y mm
NISSAN Tiida Latio, 4-dr Sedan, 04- (JPN)	39 3/8"	1001 mm
NISSAN Versa, 4-dr Sedan, *07-10	39 3/8"	1001 mm

4

NISSAN Tiida Latio, 4-dr Sedan, 04- (JPN)

NISSAN Versa, 4-dr Sedan, *07-10

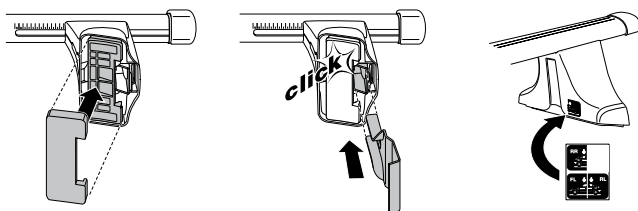
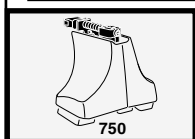
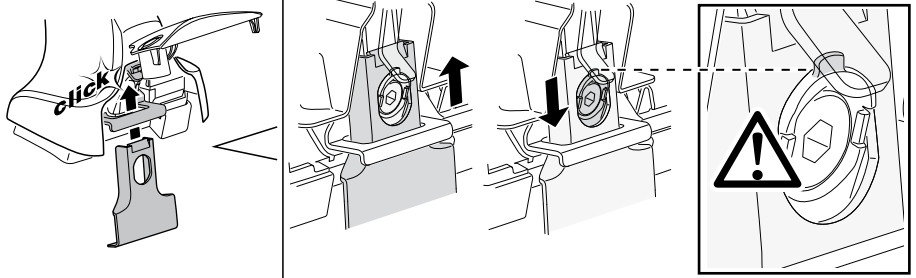
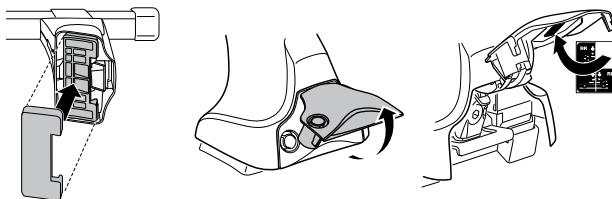
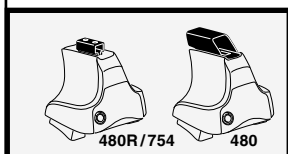

5



	X mm	Y mm	X inch	Y inch
NISSAN Tiida Latio, 4-dr Sedan, 04- (JPN)	465 mm	680 mm	18 1/4"	26 3/4"
NISSAN Versa, 4-dr Sedan, *07-10	465 mm	680 mm	18 1/4"	26 3/4"

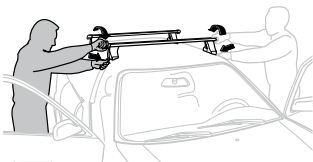
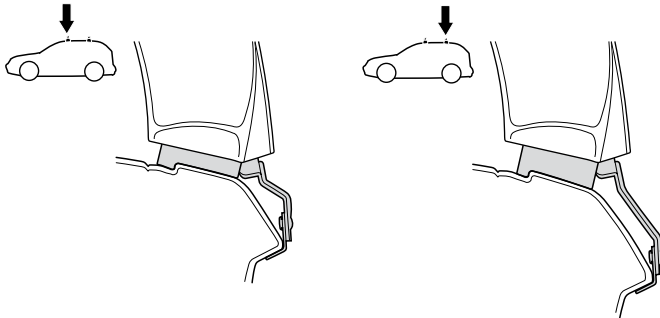
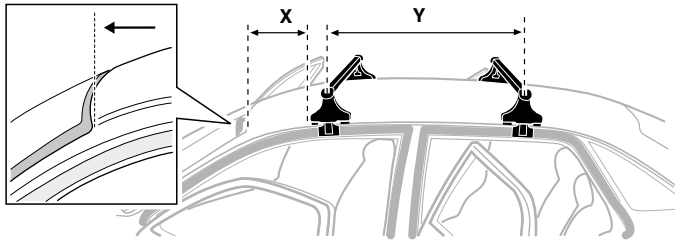

- | | | | |
|--------------|---|------------|---|
| GB/US | Tighten alternately | CZ | Pokrétla bagazníka dokřečaj dokřečaj naprzemiennie. |
| D | Die Schrauben abwechselnd anziehen | SK | Doťahujte striedavo |
| F | Serrer alternativement chaque côté | SLO | Privijajte izmenično. |
| NL | Afwisselend aan de linker- en de rechterkant aandraaien | HR | Naizmjenično zategnite |
| I | Alternare il serraggio delle viti | HU | Egymástól függetlenül szorítandó |
| E | Apretar alternativamente | GR | Σφιγγετε εναλλάξ |
| PT | Aperte alternadamente | TR | Dönüşümlü sıkın |
| S | Dra åt växelvis | 中文 | 交替拧紧 |
| FIN | Kierrä vuorotellen | 한국어 | 번갈아 가며 조이십시오. |
| EST | Pinguldage vaheldumisi | 日本語 | 交互に締め付けてください。 |
| LAT | Pievelciet pamišus | ไทย | ขันในแบบสลับ |
| LIT | Užsukinėkite pakaitomis | | |
| PL | Śruby dokřečaj naprzemiennie | | |
| RU | Затягивайте попеременно | | |

6



480R/754



480



*
3 Nm



*

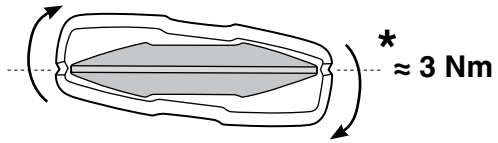

*
≈ 3 Nm

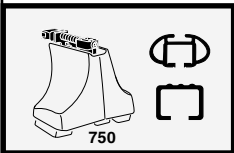

750

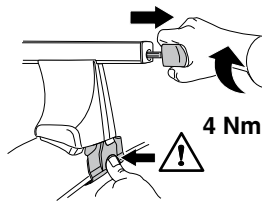

4 Nm

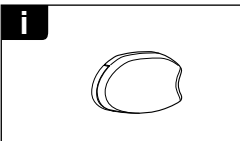
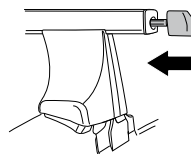

i

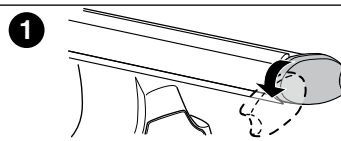

1

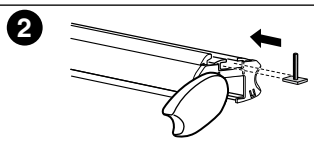

2

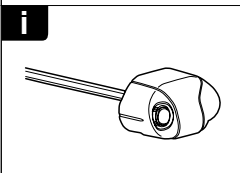

i

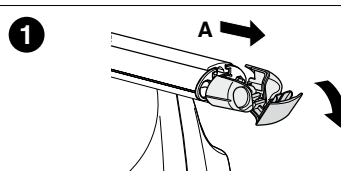

1

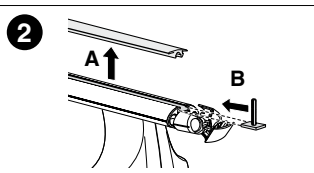

2

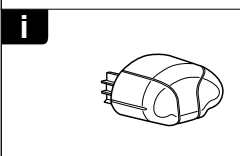

i

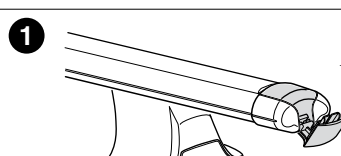

1

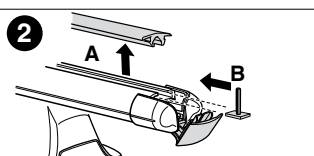

2

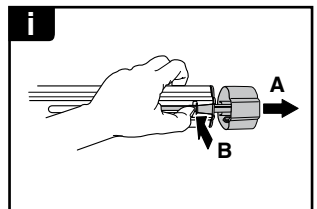
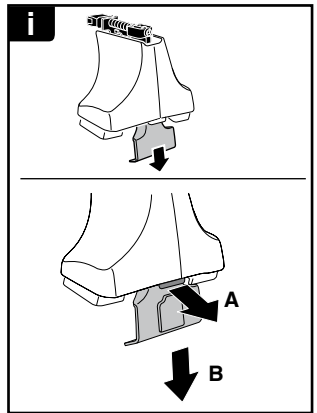
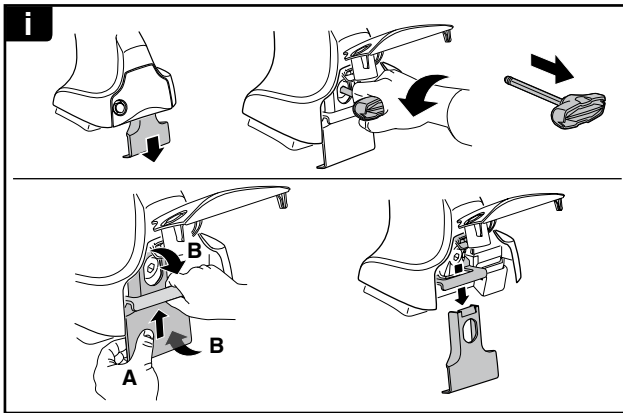
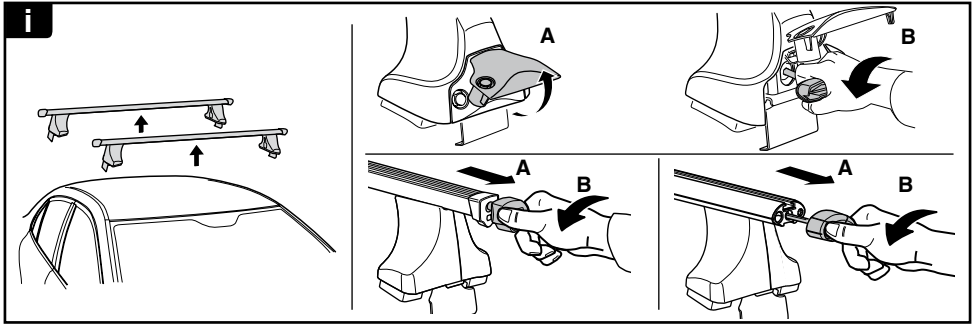

THULE
SWEDEN
**ONE
KEY
SYSTEM**



- 544 (x4)
- 596 (x6)
- 588 (x8)
- NA 510 (x10)
- EUR 452 (x12)
- ASIA

