

Kit 1312

HONDA Fit, 5-dr Hatchback, 02-04, 05-07 / *07-08

HONDA Jazz, 5-dr Hatchback, 02-04, 05-08

*North America

480R
754

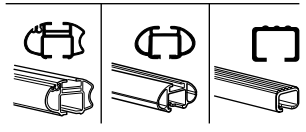
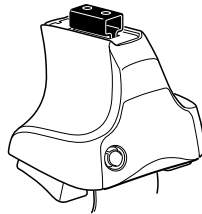

480

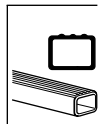
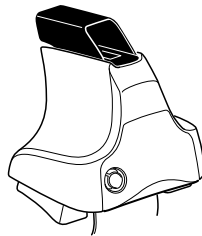

750

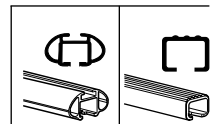
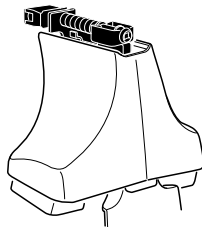

x2 x2 x2 x4	x2	x2 x2 x4 x4	x2 x2	x2

560 x 4

06 x 2

31 x 1

37 x 1

x 1

Kit

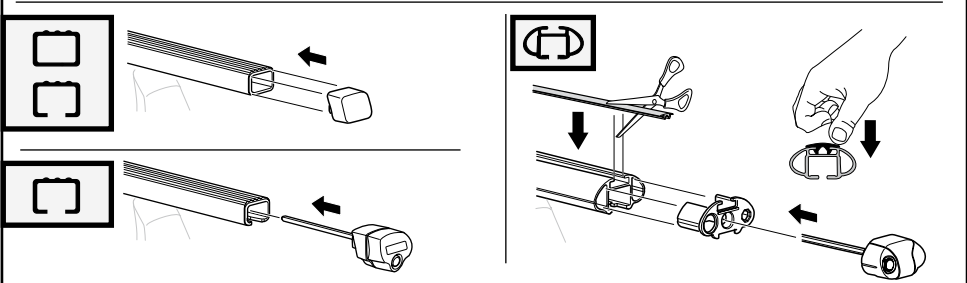
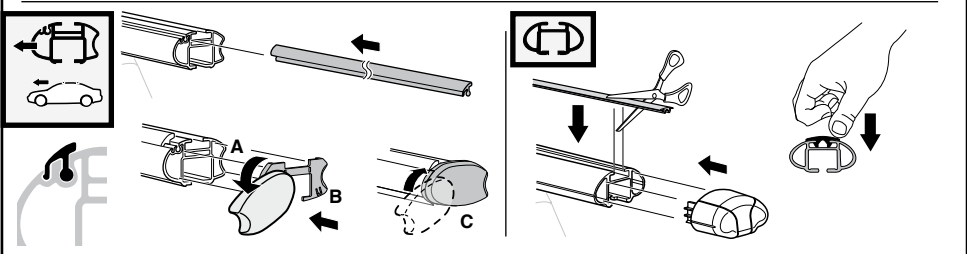
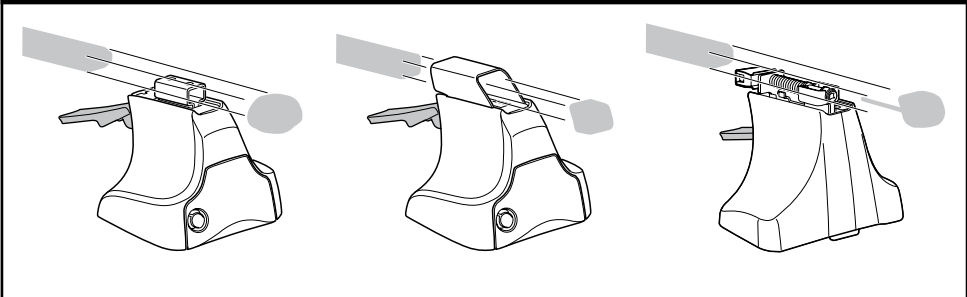
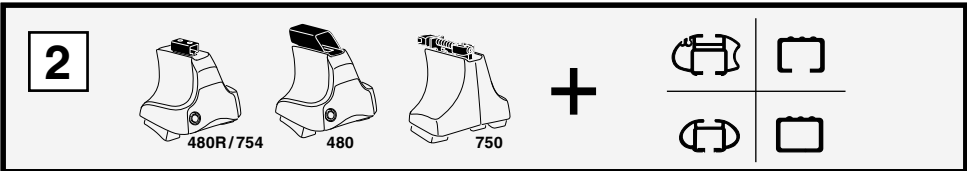
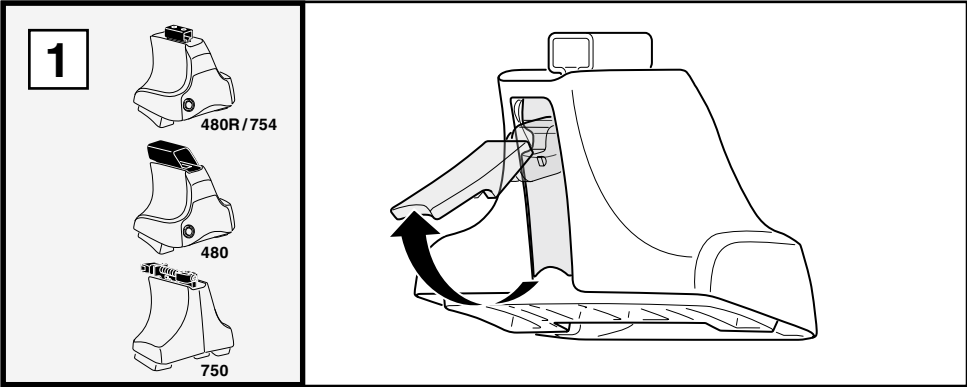

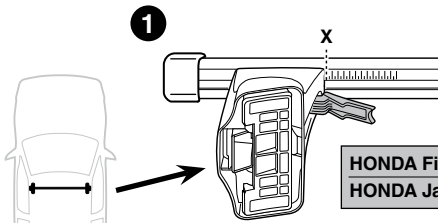
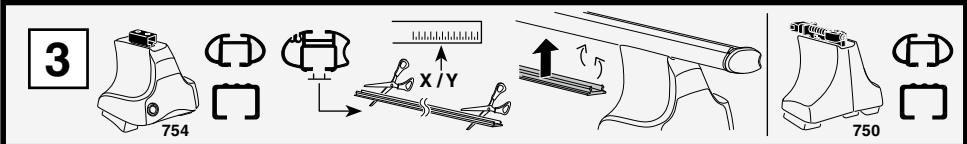

	X
HONDA Fit, 5-dr Hatchback, 02-04, 05-07 / *07-08	30,5
HONDA Jazz, 5-dr Hatchback, 02-04, 05-08	30,5

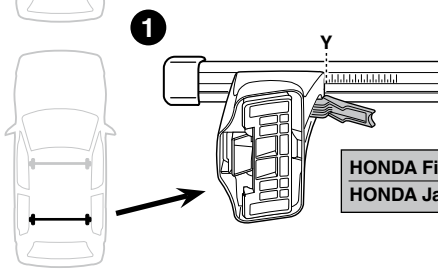

	Y
HONDA Fit, 5-dr Hatchback, 02-04, 05-07 / *07-08	26,5
HONDA Jazz, 5-dr Hatchback, 02-04, 05-08	26,5

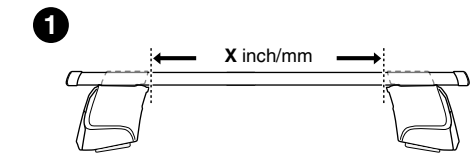
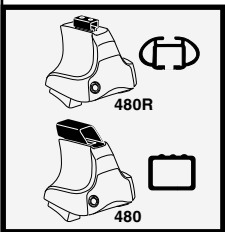
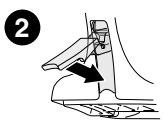

	X inch	X mm
HONDA Fit, 5-dr Hatchback, 02-04, 05-07 / *07-08	37 ⁵ / ₈ "	956 mm
HONDA Jazz, 5-dr Hatchback, 02-04, 05-08	37 ⁵ / ₈ "	956 mm

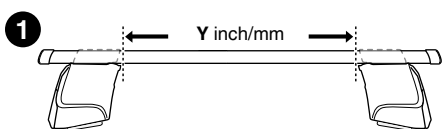
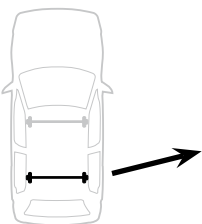

	Y inch	Y mm
HONDA Fit, 5-dr Hatchback, 02-04, 05-07 / *07-08	36 ¹ / ₈ "	916 mm
HONDA Jazz, 5-dr Hatchback, 02-04, 05-08	36 ¹ / ₈ "	916 mm

4

HONDA Fit, 5-dr Hatchback, 02-04, 05-07 / *07-08

HONDA Jazz, 5-dr Hatchback, 02-04, 05-08

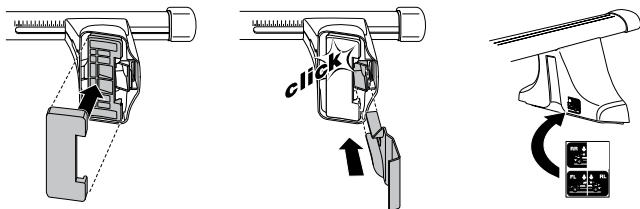
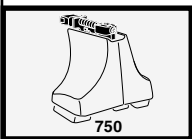
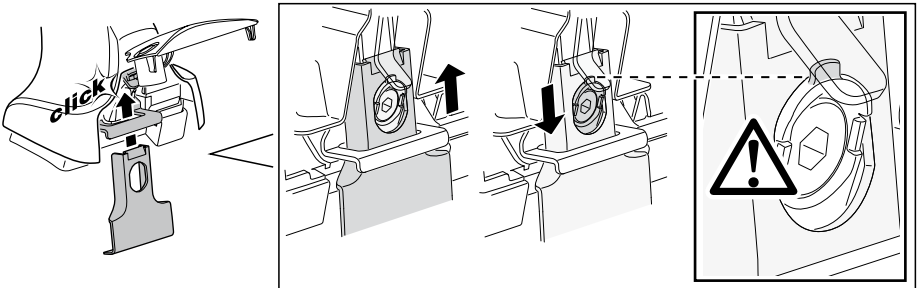
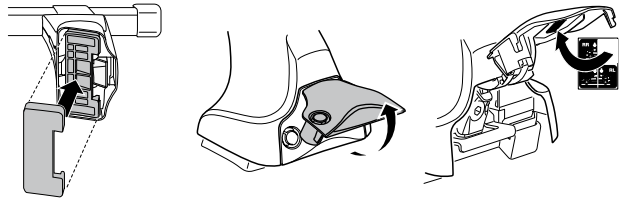
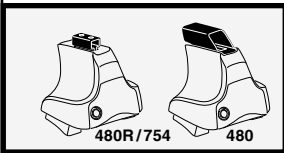
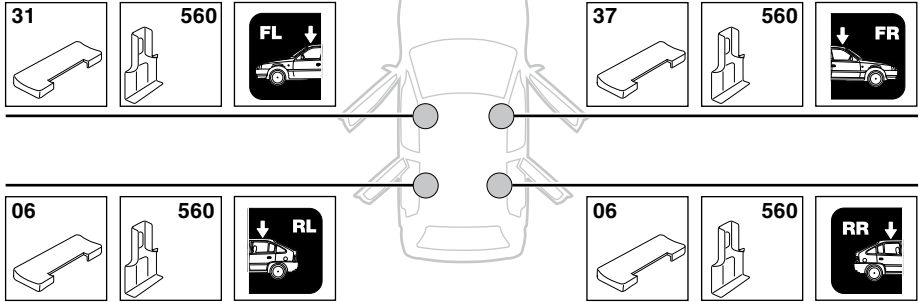

5



	X mm	Y mm	X inch	Y inch
HONDA Fit, 5-dr Hatchback, 02-04, 05-07 / *07-08	300 mm	700 mm	11 ³ / ₄ "	27 ¹ / ₄ "
HONDA Jazz, 5-dr Hatchback, 02-04, 05-08	300 mm	700 mm	11 ³ / ₄ "	27 ¹ / ₄ "

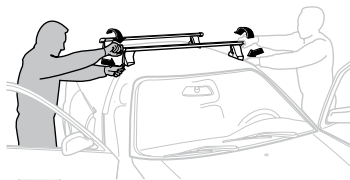
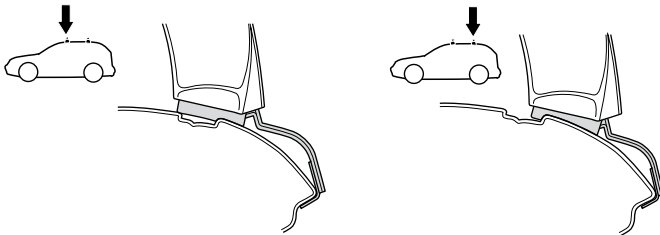
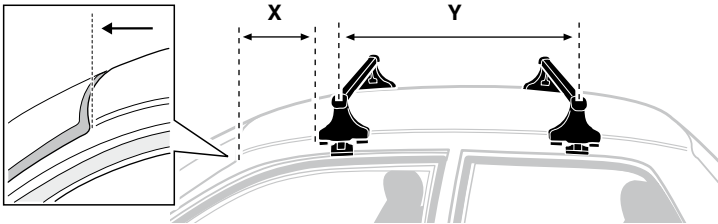

GB/US Tighten alternately

D Die Schrauben abwechselnd anziehen

F Serrer alternativement chaque côté

NL Afwisselend aan de linker- en de rechterkant aandraaien

I Alternare il serraggio delle viti

E Serrare alternativamente

PT Aperte alternadamente

S Dra åt växelvis

FIN Kierrä vuorotellen

EST Pinguldage vaheldumisi

LAT Pielieciet pamišus

LIT Užsukinėkite pakaitomis

PL Śruby dokręcaj naprzemiennie

RU Затягивайте попеременно

CZ Pokręťta bagažníka dokręcaj dokręcaj naprzemiennie.

SK Doťahujte striedavo

SLO Privijajte izmenično.

HR Naizmjenično zategnite

HU Egymástól függetlenül szorítandó

GR Σφιγγετε εναλλάξ

TR Dönüşümlü sıkın

中文 交替拧紧

한국어 번갈아 가며 조이십시오.

日本語 交互に締め付けてください。

ไทย ชั้้นในแบบสลับ

6



480R/754



480

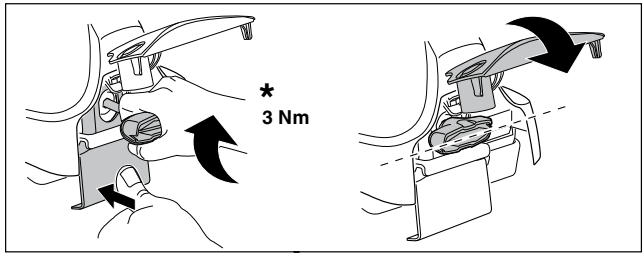

*
3 Nm



*



*
≈ 3 Nm

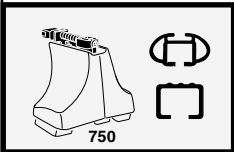
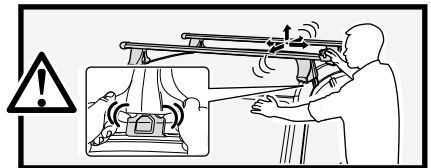

750

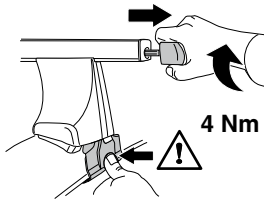

4 Nm

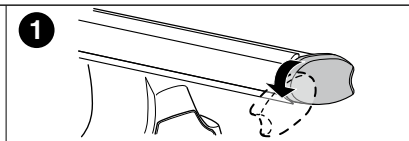
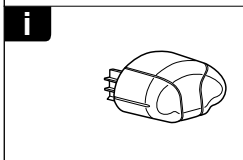
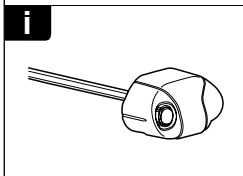
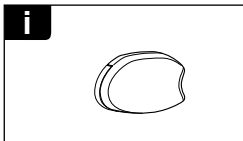
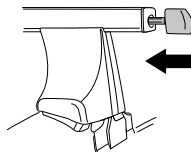

1

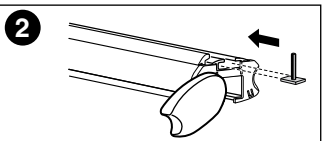

2

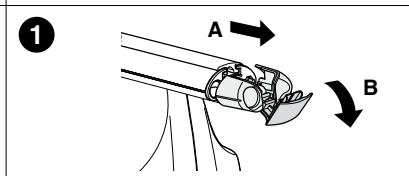

1

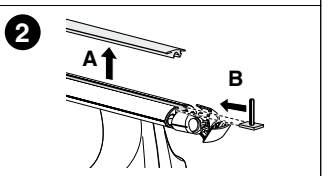

2

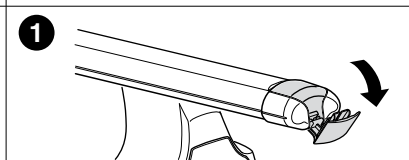

1

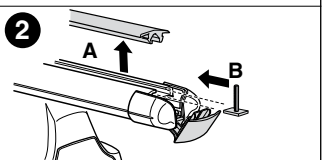

2



THULE
SWEDEN
**ONE
KEY
SYSTEM**



- 544 (x4)
- 596 (x6)
- 588 (x8)
- NA 510 (x10)
- EUR 452 (x12)
- ASIA



WW ▶ Thule Sweden AB, Box 69, 330 33 Hillerstorp, SWEDEN
NA ▶ Thule Inc., 42 Silvermine Road, Seymour, Connecticut 06483, USA

info@thule.com
customer.service@thule.com

www.thule.com