

# Kit 1303

- CHEVROLET Aveo**, 3-dr Hatchback, 02–
- CHEVROLET Aveo**, 5-dr Hatchback, 02– / \*04-06, 07–
- CHEVROLET Kalos**, 3-dr Hatchback, 02–
- CHEVROLET Kalos**, 5-dr Hatchback, 02–
- DAEWOO Kalos**, 3-dr Hatchback, 02–
- DAEWOO Kalos**, 5-dr Hatchback, 02–
- PONTIAC G3**, 5-dr Hatchback, \*08-10
- PONTIAC G3 Wave**, 5-dr Hatchback, \*08-10
- PONTIAC Wave**, 5-dr Hatchback, \*04-07

\*North America

480R  
754

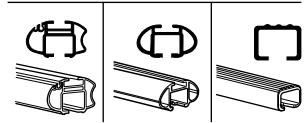
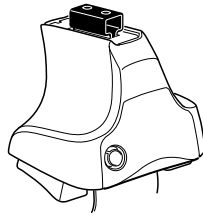

480

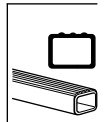
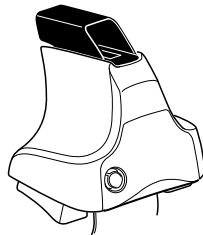

750

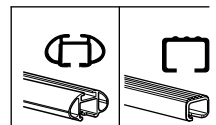
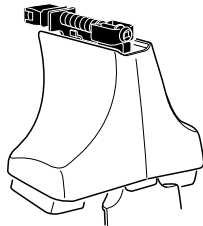

**THULE**<sup>®</sup>  
SWEDEN

ISO 11154-E

**3-dr**      **Max.**  
**45kg/99 lbs**

**5-dr**      **Max.**  
**50kg/110 lbs**

**km/h**  
**Mph**

**+**

**x1**

**x4**

**x4**

**x4**

**x4**

---

**x1**

**x4**

**x4**

**x4**

---

**x1**

**x4**

**x4**

**750**

<b>x2</b> <b>x2</b> <b>x2</b> <b>x4</b>	<b>x2</b>	<b>x2</b> <b>x2</b> <b>x4</b> <b>x4</b>	<b>x2</b> <b>x2</b>	<b>x2</b>
--	-----------	--	------------------------	-----------

**511** **x4**

**839** **x1**

**182** **x2**

**840** **x1**

**127** **x4**

**x1**

**Kit**

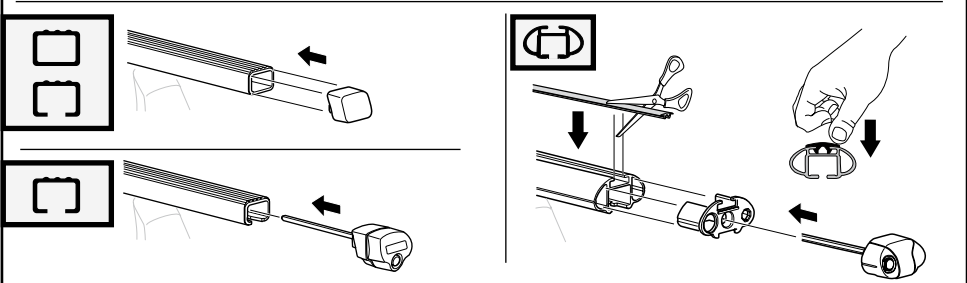
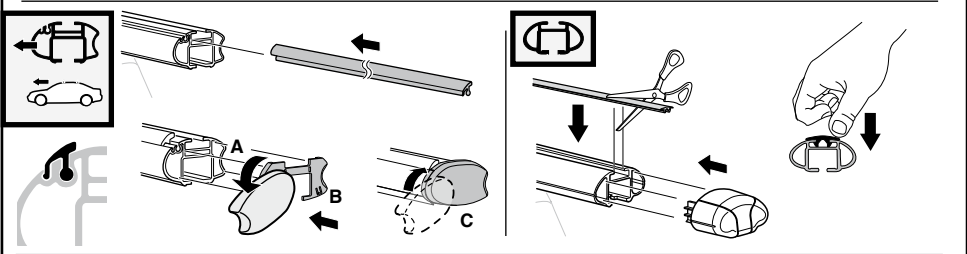
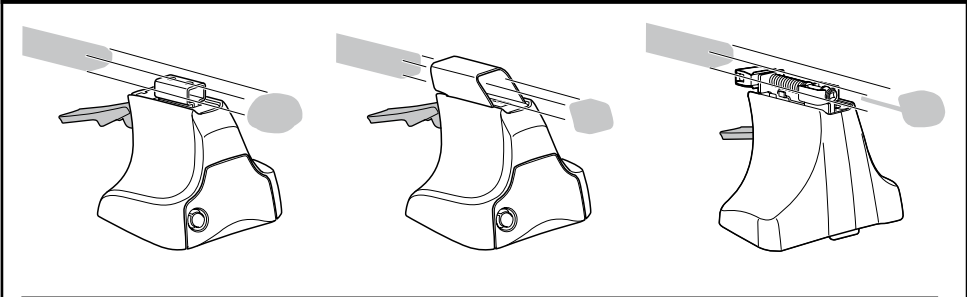
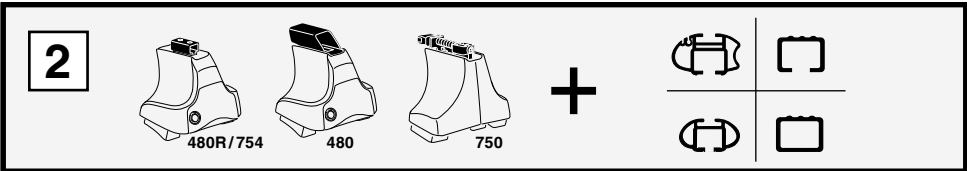
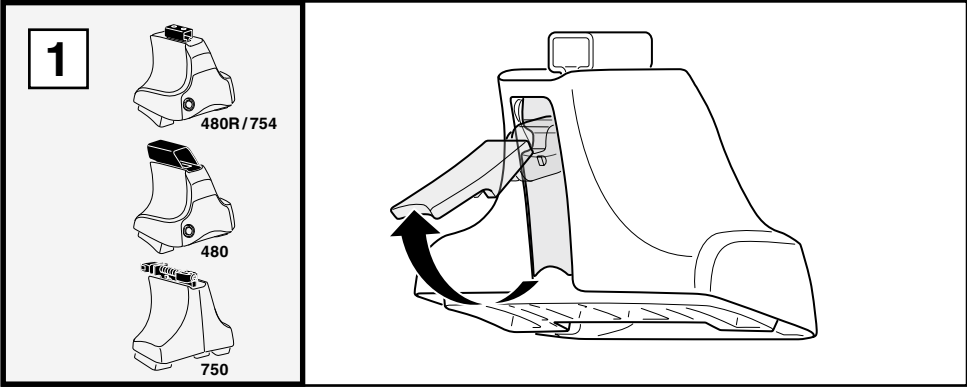

3

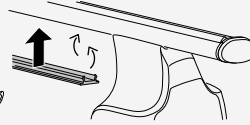
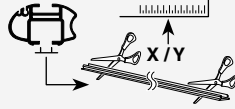
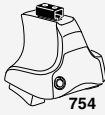

1

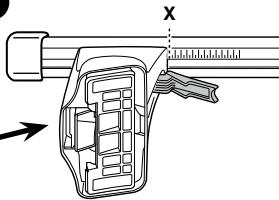
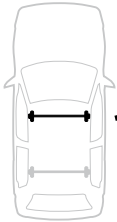

2

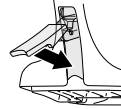

X

<b>CHEVROLET Aveo</b> , 3-dr Hatchback, 02-	28
<b>CHEVROLET Aveo</b> , 5-dr Hatchback, 02- / *04-06, 07-	28
<b>CHEVROLET Kalos</b> , 3-dr Hatchback, 02-	28
<b>CHEVROLET Kalos</b> , 5-dr Hatchback, 02-	28
<b>DAEWOO Kalos</b> , 3-dr Hatchback, 02-	28
<b>DAEWOO Kalos</b> , 5-dr Hatchback, 02-	28
<b>PONTIAC G3</b> , 5-dr Hatchback, *08-10	28
<b>PONTIAC G3 Wave</b> , 5-dr Hatchback, *08-10	28
<b>PONTIAC Wave</b> , 5-dr Hatchback, *04-07	28

1

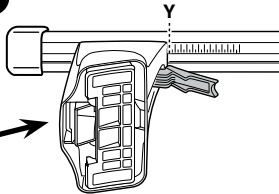
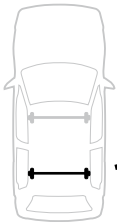

2

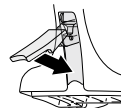

Y

<b>CHEVROLET Aveo</b> , 3-dr Hatchback, 02-	30
<b>CHEVROLET Aveo</b> , 5-dr Hatchback, 02- / *04-06, 07-	25
<b>CHEVROLET Kalos</b> , 3-dr Hatchback, 02-	30
<b>CHEVROLET Kalos</b> , 5-dr Hatchback, 02-	25
<b>DAEWOO Kalos</b> , 3-dr Hatchback, 02-	30
<b>DAEWOO Kalos</b> , 5-dr Hatchback, 02-	25
<b>PONTIAC G3</b> , 5-dr Hatchback, *08-10	25
<b>PONTIAC G3 Wave</b> , 5-dr Hatchback, *08-10	25
<b>PONTIAC Wave</b> , 5-dr Hatchback, *04-07	25

**3**



480R



480

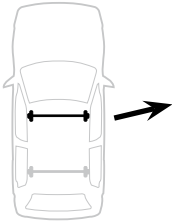
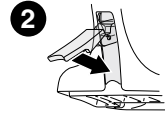
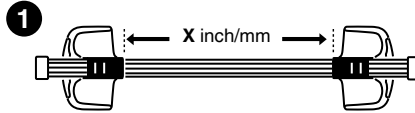

	X inch	X mm
<b>CHEVROLET Aveo</b> , 3-dr Hatchback, 02-	36 <sup>5</sup> / <sub>8</sub> "	931 mm
<b>CHEVROLET Aveo</b> , 5-dr Hatchback, 02- / *04-06, 07-	36 <sup>5</sup> / <sub>8</sub> "	931 mm
<b>CHEVROLET Kalos</b> , 3-dr Hatchback, 02-	36 <sup>5</sup> / <sub>8</sub> "	931 mm
<b>CHEVROLET Kalos</b> , 5-dr Hatchback, 02-	36 <sup>5</sup> / <sub>8</sub> "	931 mm
<b>DAEWOO Kalos</b> , 3-dr Hatchback, 02-	36 <sup>5</sup> / <sub>8</sub> "	931 mm
<b>DAEWOO Kalos</b> , 5-dr Hatchback, 02-	36 <sup>5</sup> / <sub>8</sub> "	931 mm
<b>PONTIAC G3</b> , 5-dr Hatchback, *08-10	36 <sup>5</sup> / <sub>8</sub> "	931 mm
<b>PONTIAC G3 Wave</b> , 5-dr Hatchback, *08-10	36 <sup>5</sup> / <sub>8</sub> "	931 mm
<b>PONTIAC Wave</b> , 5-dr Hatchback, *04-07	36 <sup>5</sup> / <sub>8</sub> "	931 mm

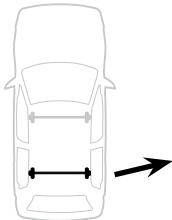
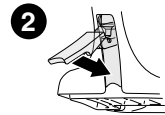
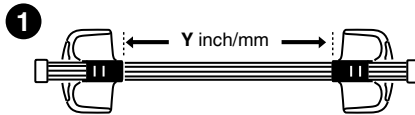

	Y inch	Y mm
<b>CHEVROLET Aveo</b> , 3-dr Hatchback, 02-	37 <sup>1</sup> / <sub>2</sub> "	951 mm
<b>CHEVROLET Aveo</b> , 5-dr Hatchback, 02- / *04-06, 07-	35 <sup>1</sup> / <sub>2</sub> "	901 mm
<b>CHEVROLET Kalos</b> , 3-dr Hatchback, 02-	37 <sup>1</sup> / <sub>2</sub> "	951 mm
<b>CHEVROLET Kalos</b> , 5-dr Hatchback, 02-	35 <sup>1</sup> / <sub>2</sub> "	901 mm
<b>DAEWOO Kalos</b> , 3-dr Hatchback, 02-	37 <sup>1</sup> / <sub>2</sub> "	951 mm
<b>DAEWOO Kalos</b> , 5-dr Hatchback, 02-	35 <sup>1</sup> / <sub>2</sub> "	901 mm
<b>PONTIAC G3</b> , 5-dr Hatchback, *08-10	35 <sup>1</sup> / <sub>2</sub> "	901 mm
<b>PONTIAC G3 Wave</b> , 5-dr Hatchback, *08-10	35 <sup>1</sup> / <sub>2</sub> "	901 mm
<b>PONTIAC Wave</b> , 5-dr Hatchback, *04-07	35 <sup>1</sup> / <sub>2</sub> "	901 mm

4

CHEVROLET Aveo, 3-dr Hatchback, 02-  
CHEVROLET Kalos, 3-dr Hatchback, 02-  
DAEWOO Kalos, 3-dr Hatchback, 02-

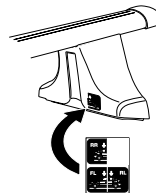
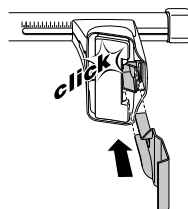
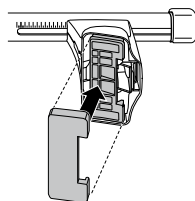
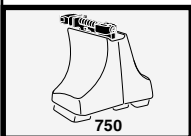
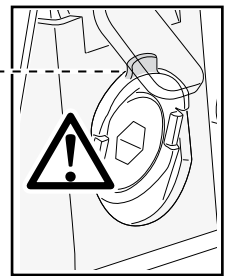
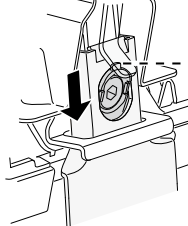
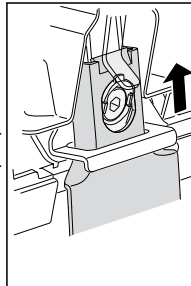
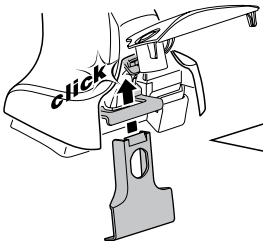
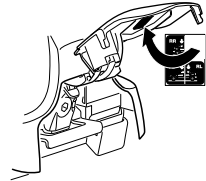
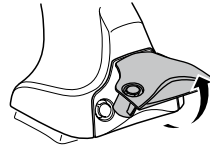
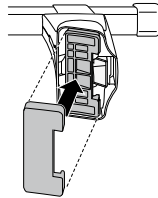
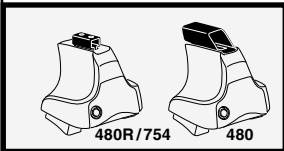
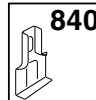
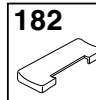
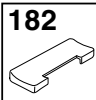
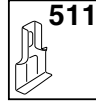
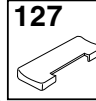
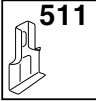
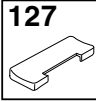

**4**

**CHEVROLET Aveo**, 5-dr Hatchback, 02- / \*04-06, 07-  
**CHEVROLET Kalos**, 5-dr Hatchback, 02-  
**DAEWOO Kalos**, 5-dr Hatchback, 02-  
**PONTIAC G3**, 5-dr Hatchback, \*08-10  
**PONTIAC G3 Wave**, 5-dr Hatchback, \*08-10  
**PONTIAC Wave**, 5-dr Hatchback, \*04-07

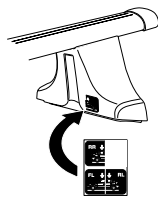
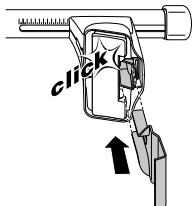
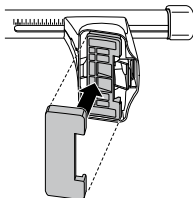
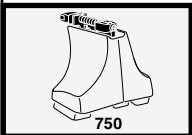
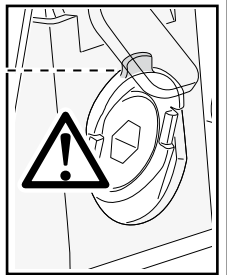
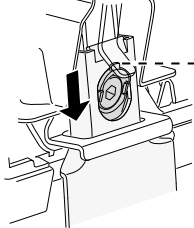
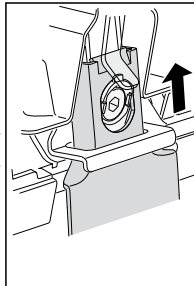
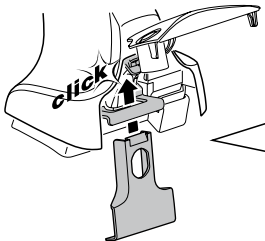
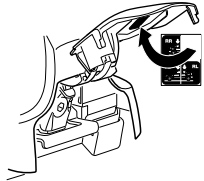
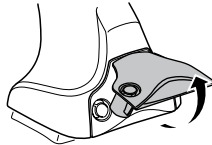
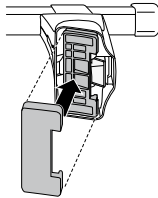
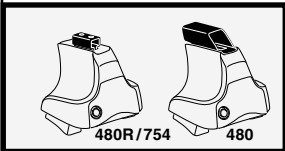
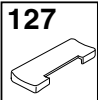
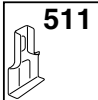
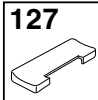
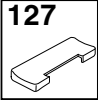
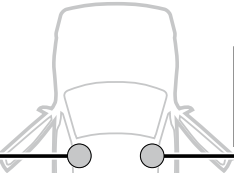
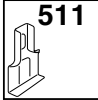
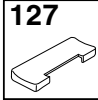

# 5

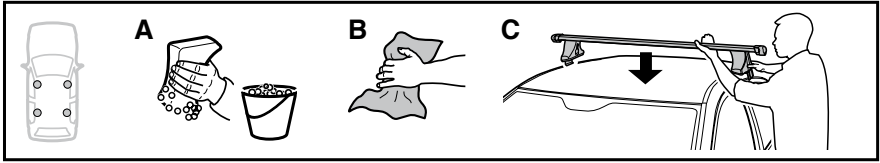

	X mm	Y mm	X inch	Y inch
<b>CHEVROLET Aveo</b> , 3-dr Hatchback, 02-	380 mm	750 mm	15 "	29 1/2 "
<b>CHEVROLET Aveo</b> , 5-dr Hatchback, 02- / *04-06, 07-	380 mm	700 mm	15 "	27 1/2 "
<b>CHEVROLET Kalos</b> , 3-dr Hatchback, 02-	380 mm	750 mm	15 "	29 1/2 "
<b>CHEVROLET Kalos</b> , 5-dr Hatchback, 02-	380 mm	700 mm	15 "	27 1/2 "
<b>DAEWOO Kalos</b> , 3-dr Hatchback, 02-	380 mm	750 mm	15 "	29 1/2 "
<b>DAEWOO Kalos</b> , 5-dr Hatchback, 02-	380 mm	700 mm	15 "	27 1/2 "
<b>PONTIAC G3</b> , 5-dr Hatchback, *08-10	380 mm	700 mm	15 "	27 1/2 "
<b>PONTIAC G3 Wave</b> , 5-dr Hatchback, *08-10	380 mm	700 mm	15 "	27 1/2 "
<b>PONTIAC Wave</b> , 5-dr Hatchback, *04-07	380 mm	700 mm	15 "	27 1/2 "

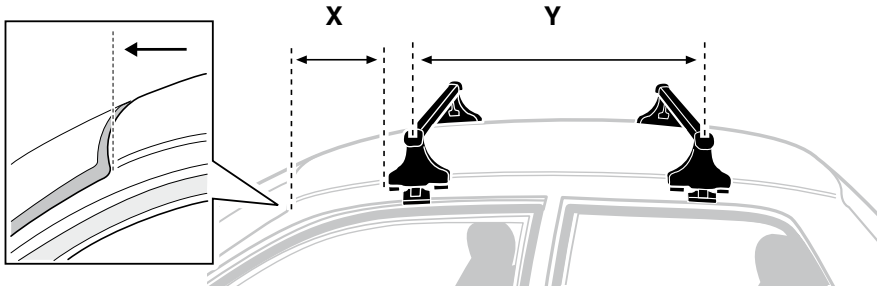



6

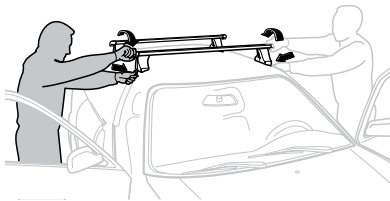
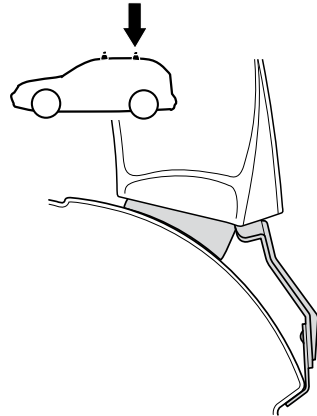
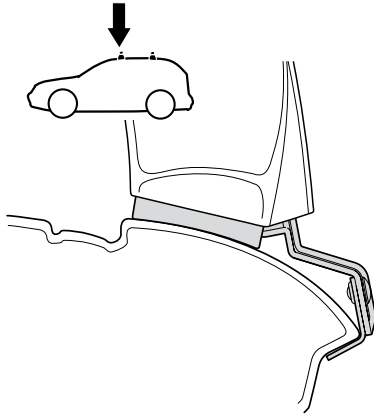

**GB/US** Tighten alternately

**D** Die Schrauben abwechselnd anziehen

**F** Serrer alternativement chaque côté

**NL** Afwisselend aan de linker- en de rechterkant aandraaien

**I** Alternare il serraggio delle viti

**E** Serrare alternativamente

**PT** Aperte alternadamente

**S** Dra åt växelvis

**FIN** Kierrä vuorotellen

**EST** Pinguldage vaheldumisi

**LAT** Pievelciet pamīšus

**LIT** Užsukinėkite pakaitomis

**PL** Śruby dokręcaj naprzemiennie

**RU** Затягивайте попеременно

**CZ** Pokręťta багаžníka dokręcaj dokręcaj naprzemiennie.

**SK** Doťahujte striedavo

**SLO** Privijajte izmenično.

**HR** Naizmjenično zategnite

**HU** Egymástól függetlenül szorítandó

**GR** Σφίγγετε εναλλάξ

**TR** Dönüşümlü sıkın

**中文** 交替拧紧

**한국어** 번갈아 가며 조이십시오.

**日本語** 交互に締め付けてください。

**ไทย** ชันในแบบสลับ

7

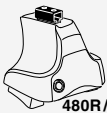

480R/754



480

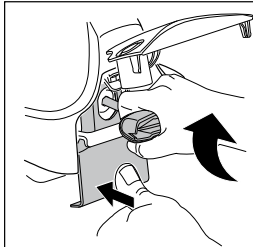
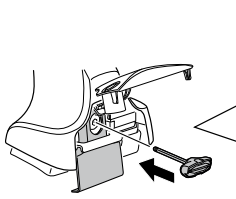

\*  
3 Nm

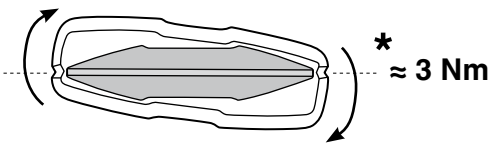
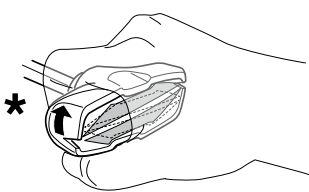
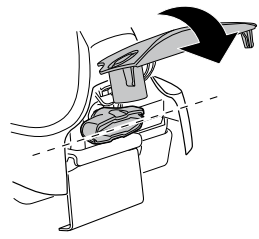

\*  
≈ 3 Nm

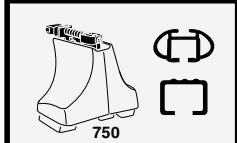
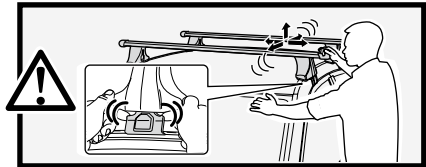

750

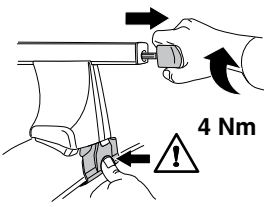

4 Nm

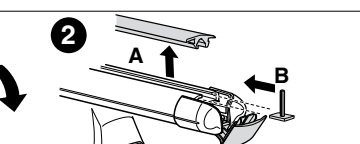
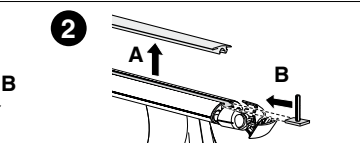
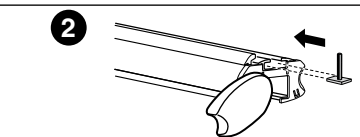
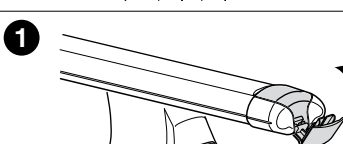
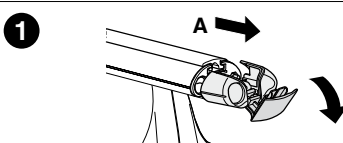
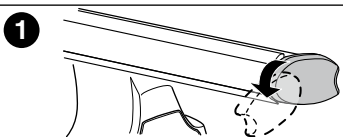
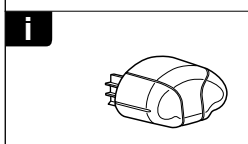
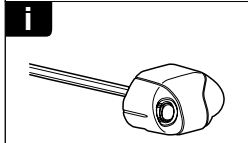
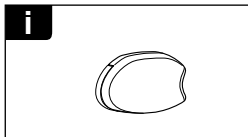
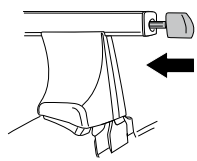



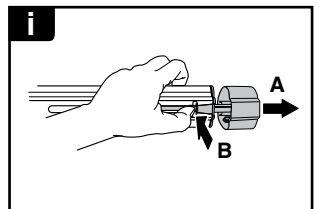
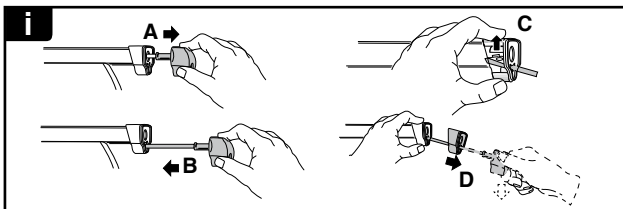
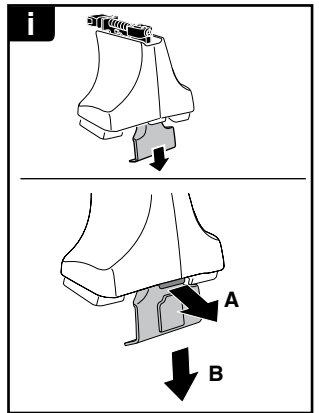
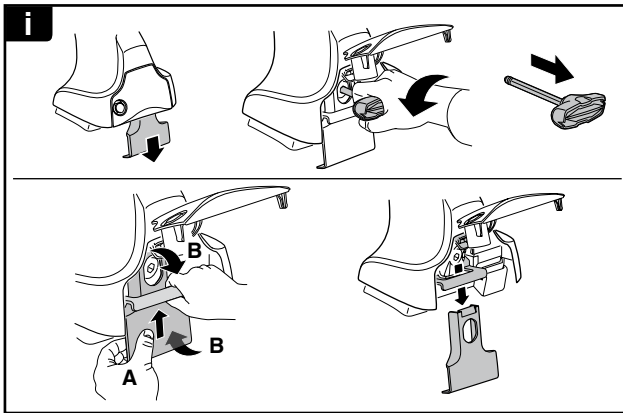
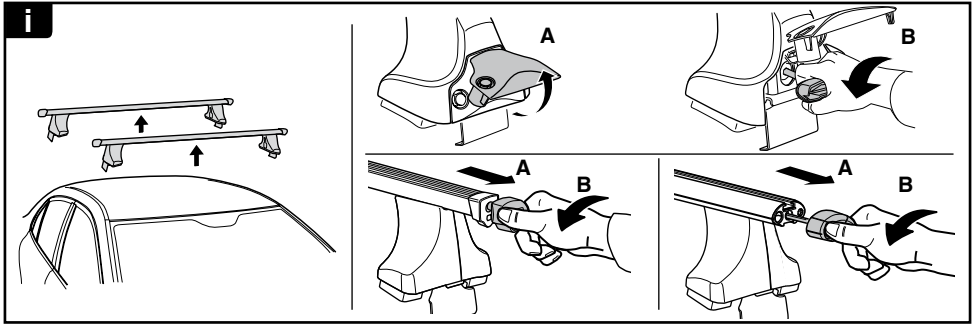

**THULE**  
SWEDEN  
**ONE  
KEY  
SYSTEM**

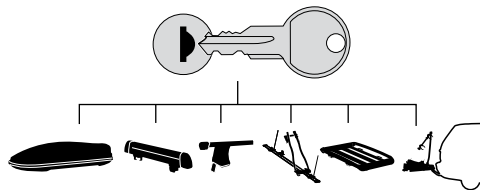

- 544** (x4)
  - 596** (x6)
  - 588** (x8)
  - 510** (x10)
  - 452** (x12)
- NA  
EUR  
ASIA

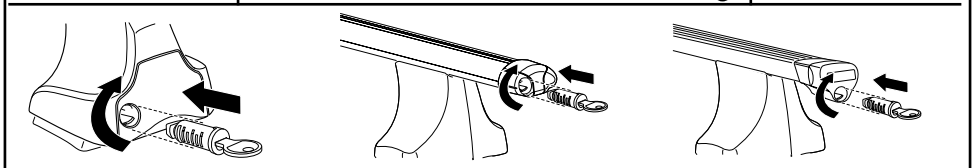

WW ▶ Thule Sweden AB, Box 69, 330 33 Hillerstorp, SWEDEN  
NA ▶ Thule Inc., 42 Silvermine Road, Seymour, Connecticut 06483, USA

info@thule.com  
customer.service@thule.com

www.thule.com