

Kit 1077

TOYOTA Avensis, 4-dr Sedan, 98-00, 01-02

TOYOTA Avensis, 5-dr Hatchback, 98-00, 01-02

480R
754

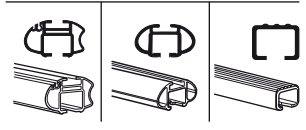
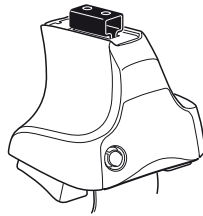

480

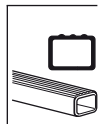
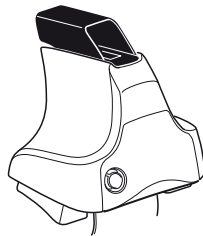

750

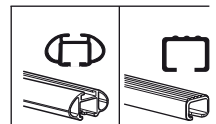
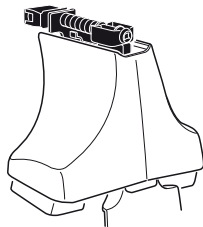

Kit





1

2

	X
TOYOTA Avensis, 4-dr Sedan, 98-00, 01-02	27
TOYOTA Avensis, 5-dr Hatchback, 98-00, 01-02	27

1

2

	Y
TOYOTA Avensis, 4-dr Sedan, 98-00, 01-02	25
TOYOTA Avensis, 5-dr Hatchback, 98-00, 01-02	25

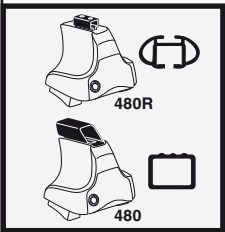

1

2

	X inch	X mm
TOYOTA Avensis, 4-dr Sedan, 98-00, 01-02	36 1/2"	921 mm
TOYOTA Avensis, 5-dr Hatchback, 98-00, 01-02	36 1/2"	921 mm

1

2

	Y inch	Y mm
TOYOTA Avensis, 4-dr Sedan, 98-00, 01-02	35 1/2"	901 mm
TOYOTA Avensis, 5-dr Hatchback, 98-00, 01-02	35 1/2"	901 mm

4

TOYOTA Avensis, 4-dr Sedan, 98-00, 01-02

TOYOTA Avensis, 5-dr Hatchback, 98-00, 01-02

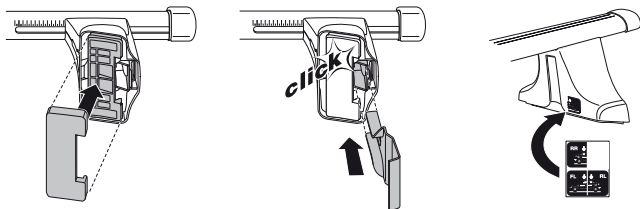
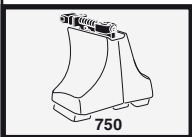
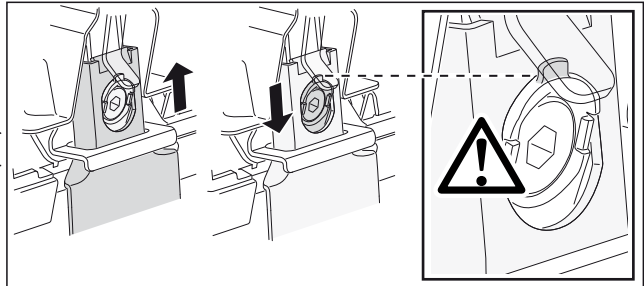
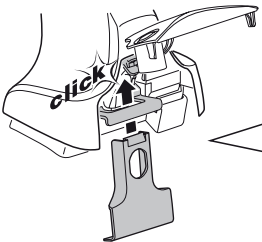
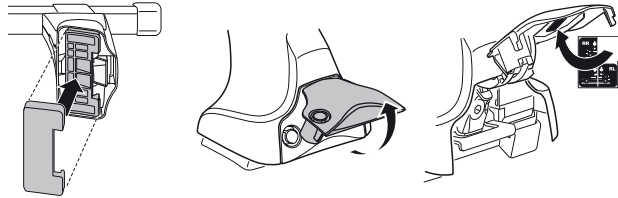
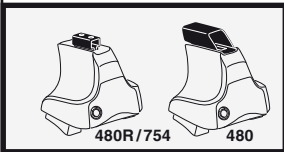
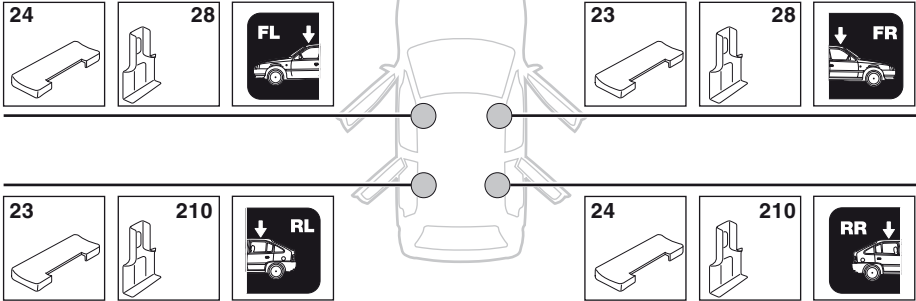

5



	X mm	Y mm	X inch	Y inch
TOYOTA Avensis, 4-dr Sedan, 98-00, 01-02	240 mm	680 mm	9 1/2"	26 3/4"
TOYOTA Avensis, 5-dr Hatchback, 98-00, 01-02	240 mm	680 mm	9 1/2"	26 3/4"

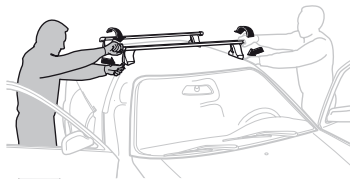
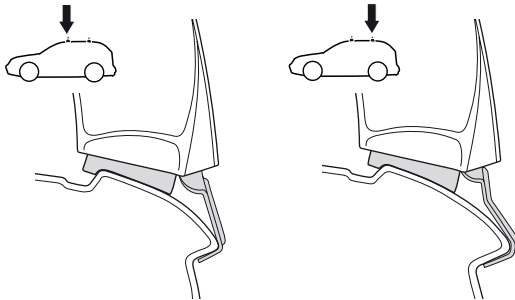
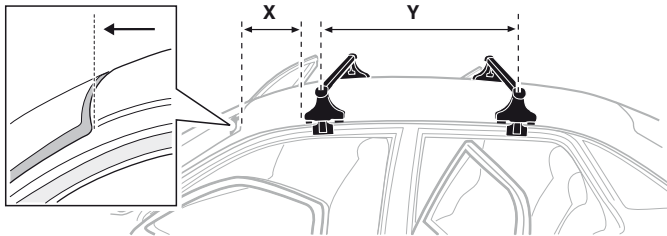

GB/US Tighten alternately

D Die Schrauben abwechselnd anziehen

F Serrer alternativement chaque côté

NL Afwisselend aan de linker- en de rechterkant aandraaien

I Alternare il serraggio delle viti

E Apretar alternativamente

PT Aperte alternadamente

S Dra åt växelvis

FIN Kierrä vuorotellen

EST Pinguldage vaheldumisi

LAT Pielieciet pamišus

LIT Užsukinėkite pakaitomis

PL Śruby dokręcaj naprzemiennie

RU Затягивайте попеременно

CZ Pokręťta bagażníka dokręcaj dokręcaj naprzemiennie.

SK Doťahujte striedavo

SLO Privijajte izmenično.

HR Naizmjenično zategnite

HU Egymástól függetlenül szorítandó

GR Σφιγγετε εναλλάξ

TR Dönüşümlü sıkın

中文 交替拧紧

한국어 번갈아 가며 조이십시오.

日本語 交互に締め付けてください。

ไทย ชั้้นในแบบสลับ

6



480R/754



480

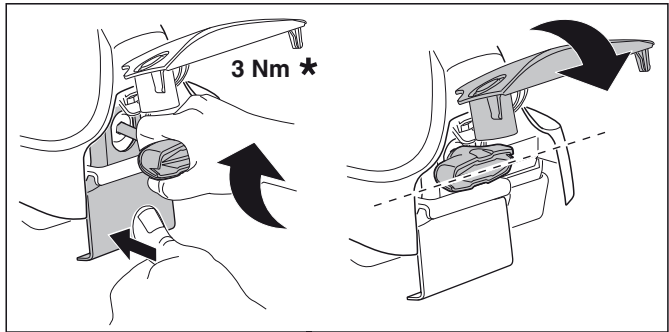
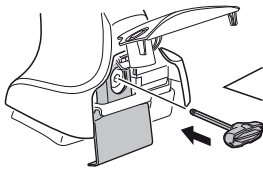

3 Nm *

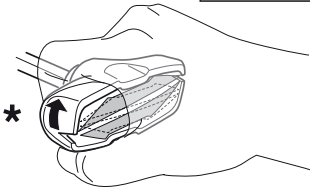

*

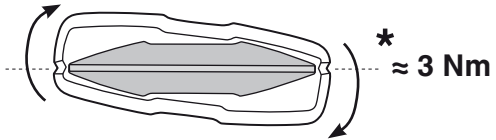

* ≈ 3 Nm



750

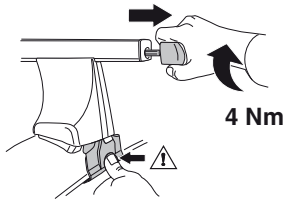

4 Nm

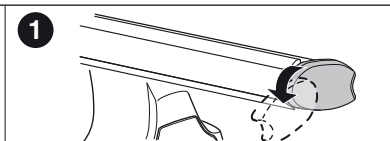
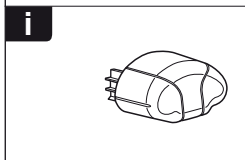
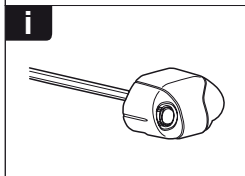
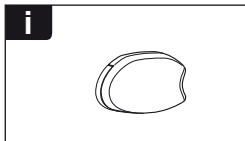
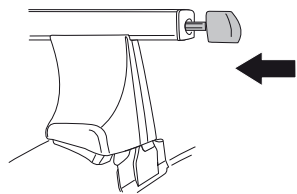

1

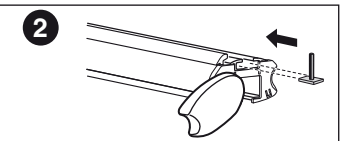

2

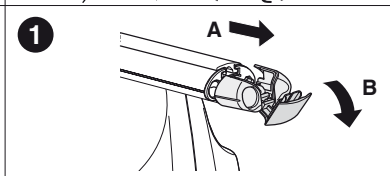

1

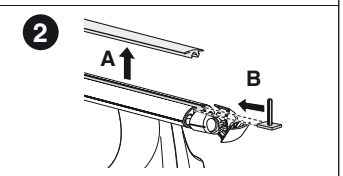

2

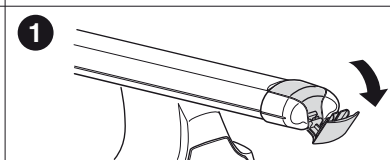

1

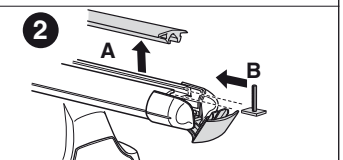

2

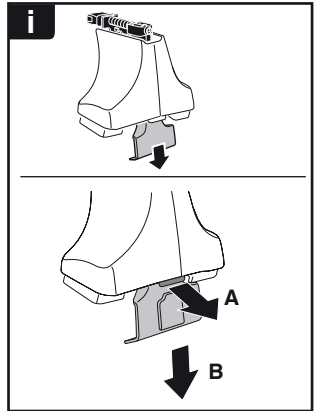
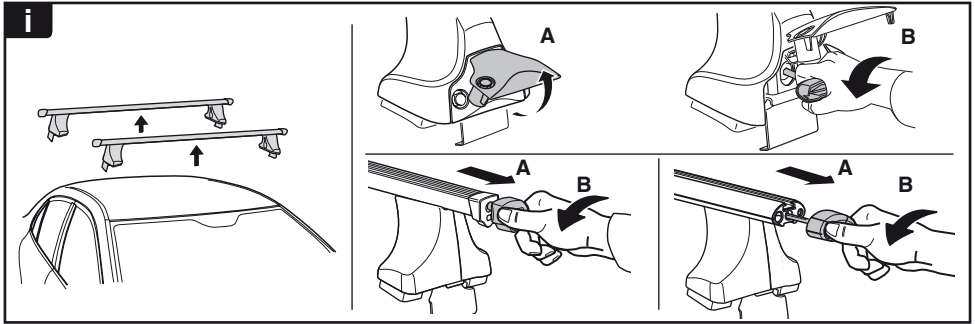

THULE
SWEDEN
**ONE
KEY
SYSTEM**



- 544 (x4)
- 596 (x6)
- 588 (x8)
- NA 510 (x10)
- EUR 452 (x12)
- ASIA



WW ▶ Thule Sweden AB, Box 69, 330 33 Hillerstorp, SWEDEN
NA ▶ Thule Inc., 42 Silvermine Road, Seymour, Connecticut 06483, USA

info@thule.com
customer.service@thule.com

www.thule.com